

# TestPro CV100

## Multifunction Cable Certifier

The changing landscape of enterprise cabling demands more from the test equipment you rely on.



# Multifunction Testing Solution

The award winning TestPro™ Multifunction Cable Certifier, offers an extensive suite of test function, through hot swappable test adapters.

If you're only looking for copper and fiber optic certification, TestPro offers competitively priced testing kits.

Need a bit more function to better manage smart building deployments or add a new service offering?

TestPro is available in complete smart building test kits, taking the guess work out of trying to figure out which adapter you need.

Additionally, there is only one high-performance TestPro platform, so any kit you purchase, is compatible with all adapters making it easy to add function as needs change.

## HIGH LEVEL TESTING SUPPORT SUMMARY



**Copper Certification** - Certify CAT 5e, 6, 6A, 7, 8.1, 8.2 and see network compliance showing all network types the link is capable of supporting up to 40 Gigabit Ethernet.



**Fiber Optic Certification** - Tier 1 certification with support for both Singlemode and Multimode. Voltage testing for hybrid powered fiber. Show network compliance for a variety of fiber networks including 100GBASE-LR4, 40GBASE-LR4 and Fiber Channel.



**Single Pair Ethernet (SPE)** - Support for SPE Cabling standards TIA 568.5, ISO/IEC TR 11801-9906-2020 and SPE Field Test standards TIA 5071 (in draft), IEC-61395-4 (in draft) with testing capability up to 1800 meters.



**Power over Ethernet** - Extensive PoE testing support includes verification of PSE configuration, TruePower load testing reporting actual current/wattage/voltage. Sustained load testing for monitoring power fluctuations.



**Multi-Gigabit Link Speed Test** - Validate 1 / 2.5 / 5 / 10GigE link speed with SNR based measurement while under both traffic and PoE load.



**Wired Network Connectivity Testing** - Quick visibility into connected devices with drill down to gain more detail about those devices. Understand connectivity with switch detail including Slot/Port/VLAN, handy troubleshooting tools including Traceroute, ping, cable toner.



**Wireless Network Connectivity Testing** - See all available Access Points (APs) and their signal strength, verify login to AP, see roaming signal strength, handy troubleshooting tools including Traceroute and ping.



# Copper Certification

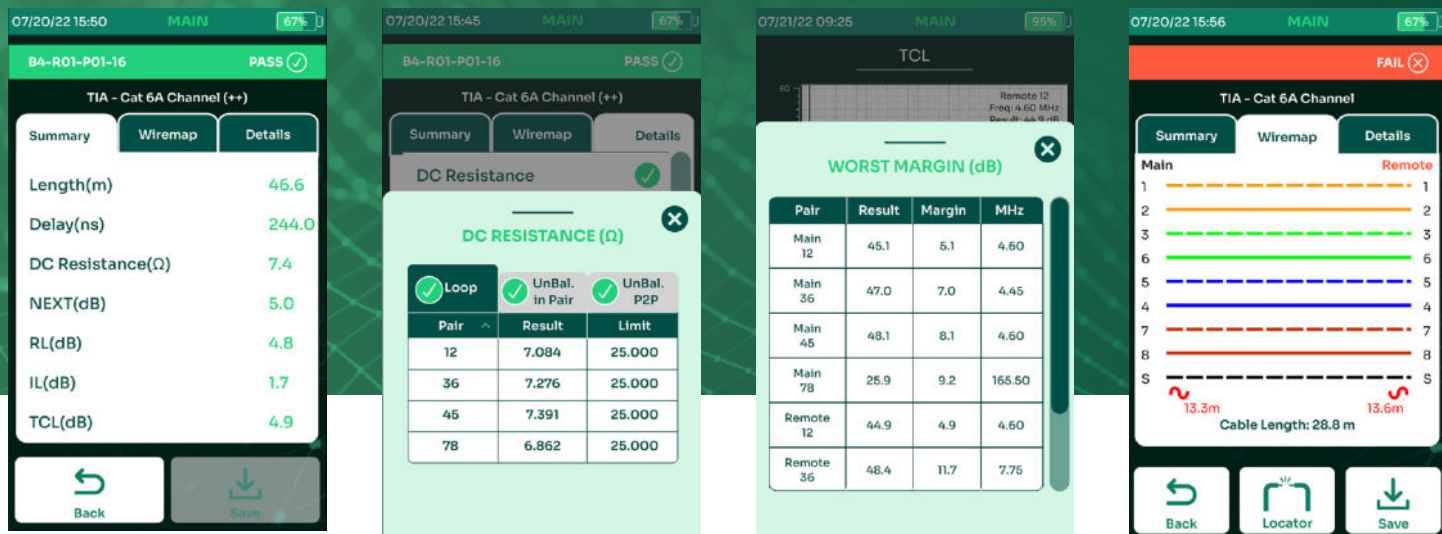

TestPro supports testing and certification for network deployments up to 40 Gigabit Ethernet for Cat 5e, 6, 6A, 7, 8 or Class I/II cabling system. The electrically centered test plug assures the Level 2G/VI accuracy required to support field testing to Cat 8 / Class I/II, and actually exceeds the 2000 MHz requirement, to offer a 3000 MHz platform. As a result, you can feel confident in results over the full frequency range.

TestPro's 6 Second Cat 6A Autotest takes only six seconds and will save you time by getting more links tested faster and with more test detail. TestPro's default Autotest includes all of the measurements you see above. Be aware of competitive tester claims for how fast their test times are, be sure you know what is and is not included in the test time quoted as compared to TestPro. Live WireMap™ provides an immediate indication of cable connection and continuity the moment the cable is connected.

As part of the **6 SECOND** CAT6A++ Autotest, TestPro will perform all standard measurements in addition to extra parameters such as **DC Resistance Unbalance, ELTCTL, TCL, fault location, and more** for both Channel and Permanent Link.

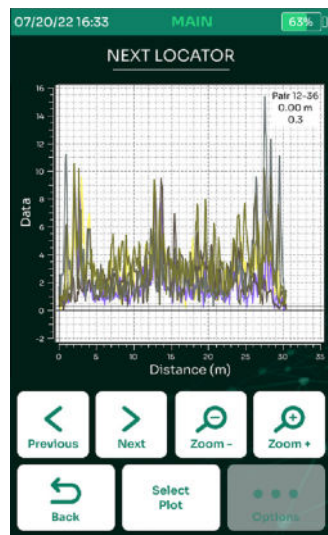

TestPro offers fault location for Return Loss, NEXT, and Shield aiding in problem identification. Support for MPTL, Patch Cord, Single Pair, GG45, Tera, and Coax is available through hot swappable adapters. At the completion of the Autotest, you get a highly visible Pass or Fail indication, and test results can be automatically saved with a customizable labeling scheme.

TestPro will store over 10,000 results in memory, but when it's time to prepare printed reports, the included TestDataPro PC based software provides a way to organize and manage results and provide printed reports. Prefer to upload as you test, TestDataPro Cloud allows you to offload test results via wired or wireless internet connection.

Channel and Permanent Link Adapters that support Cat5e-Ca68 are included in the TestPro CV100-K50E, K51E, K60E, K61E Kits.

TestPro is warranty approved by a long list of cable manufacturers. Check our website for more details.



# Fiber Optic Certification

TestPro's fiber optic measurements provide Tier-1 certification as well as customizable limits for both Multimode and Singlemode Fiber Optic premise cabling. Additionally, these adapters include an integrated Visual Fault Locator (VFL) to provide a quick indication of a break in the fiber.

For deployments where hybrid powered fiber is being used, TestPro's fiber adapter provides not only certification of the fiber optic cable, but also provides you with the ability to validate electrical voltage on the adjacent copper pair in this hybrid copper/fiber cable, it is also possible to measure the loop resistance of the pair of copper wires to ensure its integrity. This allows you to measure the electrical input voltage going into a PoE extender that is supplying PoE to end devices, and is a convenience for the technician to have everything needed for testing at their fingertips.

The Multimode adapters support testing of OM5 fiber in addition to earlier generation fiber standards. An Encircled Flux (EF) compliant Multimode source means no need for bulky external adapters.

Both SM and MM Adapters, USB Fiber Inspection Probe are included in TestPro CV100-K11E, K51E, K61E Kits.

As part of the four second Autotest, TestPro will perform the following measurements for both Singlemode and Multimode.

- Dual Ended Loss
- Single Ended Loopback Loss
- Length and Propagation Delay
- Loop Resistance of Copper Pair in Hybrid Powered Fiber
- Optical Power Meter
- 850nm, 1300nm, 1310nm, 1550nm
- LiveWiremap™
- Printed Report Includes Test Data and Compliant Networks

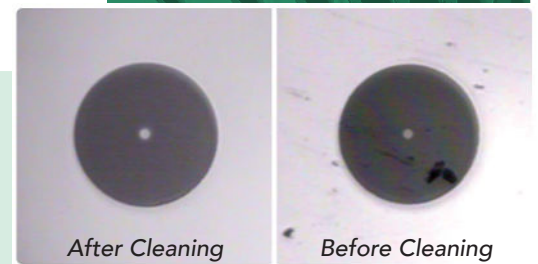

## FIBER END-FACE INSPECTION

One of the most common reasons for fiber test failures is a dirty end-face on a fiber connection. Use the USB connected Fiber Scope to ensure the fiber end face is clean before testing.

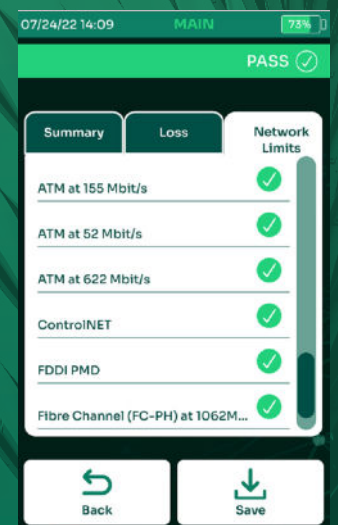
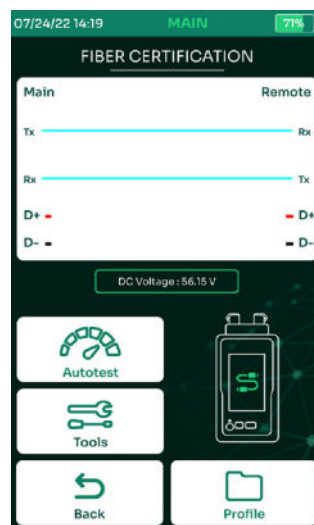
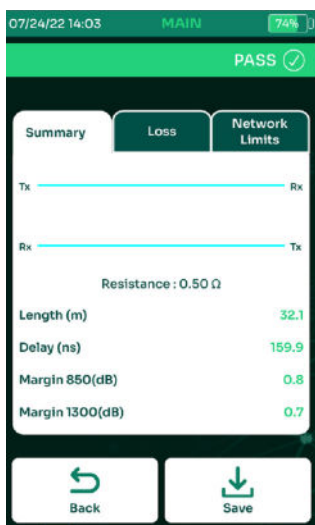



# Multi-Gigabit Link Speed Qualification

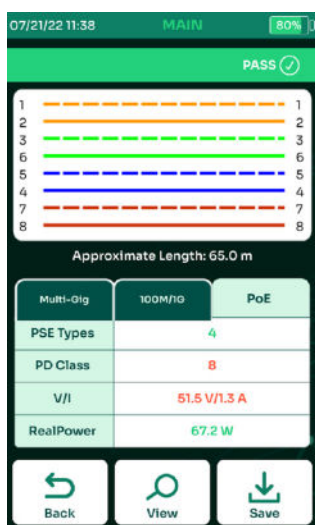
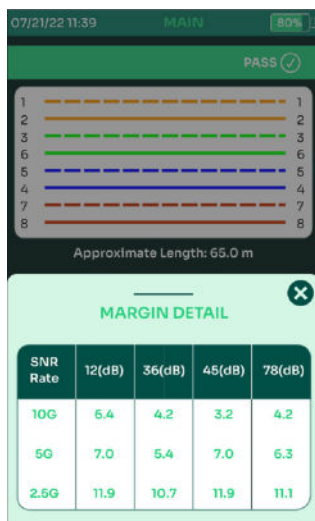
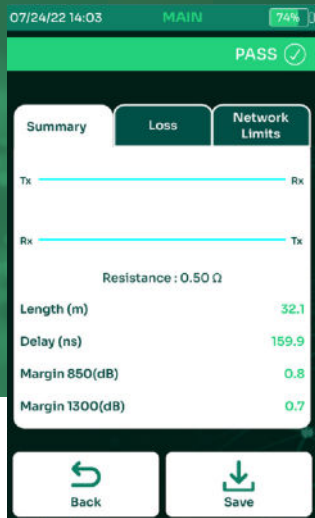
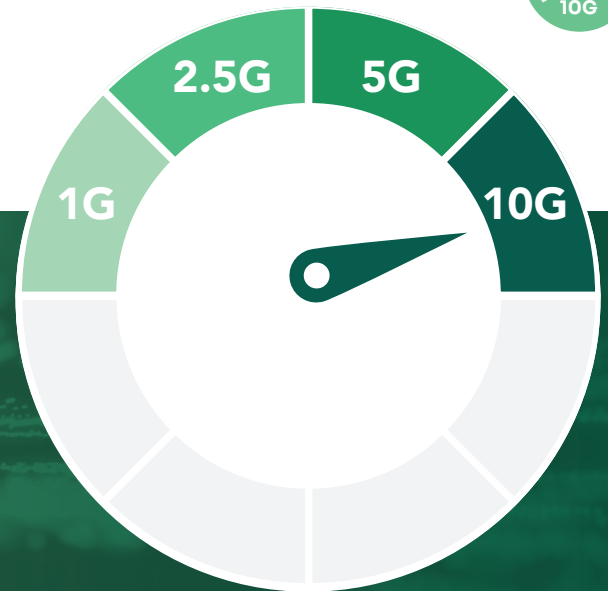

Improvements in 10Gigabit technology, price, and performance have extended its reach beyond enterprise data centers to midmarket networks. Increasing bandwidth requirements and the growth of enterprise applications are also driving broader deployments of 10 Gigabit Ethernet. TestPro’s Multi-Gigabit testing provides a Pass/Fail indication as well as visibility into available headroom even down to per pair detail.

TestPro’s Multi-Gigabit Signal to Noise Ratio (SNR) based test capability puts the link being tested under live network environment conditions with both traffic and PoE load, if a PSE is present. This provides a quick and meaningful assessment of link performance, available headroom, and even alien crosstalk effects on a link.

## VALIDATION TEST THROUGH INTEGRATED SIDE RJ-45 PORT

- 10/100 Mbps
- 1 Gbps

## POE LOAD TEST

- 802.3 af/at/bt
- UPoE

## QOS TEST

- SNR 2.5 Gigabit
- SNR 5 Gigabit
- SNR 10 Gigabit

TestPro’s Multi-Gigabit Autotest is a quick and easy one button operation to ensure that a cabling link will support the desired network rate.

Multi-Gigabit qualification testing is available in the TestPro CV100-K60E, K61E Kits. This Adapter is also sold separately: Model AD-NET-CABLE.



# Power Over Ethernet (PoE) Validation

## POE TESTING CAPABILITIES

- Load Testing for Real Power at Jack
- Current, Wattage, Voltage
- PSE Detection
- PSE Type
- PD Class
- PoE Cable Pairs
- Sustained Power Load Monitoring

TestPro excels at validating PoE with the most comprehensive test functionality available and in compliance with TIA 1152A, IEEE 802.3 af/at/bt standards, and UPoE. What sets TestPro apart is the ability to validate Real Power load at the jack where and end device will be deployed. TestPro emulates a Powered Device (PD), such as a WAP or Camera by setting it to the specific standard applicable to that device. TestPro negotiates with the Power Source Equipment (PSE) to request information about the switch and the highest level of power load from the PSE for the selected standard.

For those pesky intermittent power issues, TestPro allows for sustained loading testing over longer periods, through external loads. This allows you to monitor live for any power fluctuation that drops below the required level threshold.

TestPro can also characterize the cabling links for DC resistance unbalance parameters either as part of a standard cable certification Autotest or as a one-off quick test.

PoE Load testing is available in the TestPro CV100-K60E, K61E Kits. This Adapter is also sold separately: Model AD-NET-CABLE.

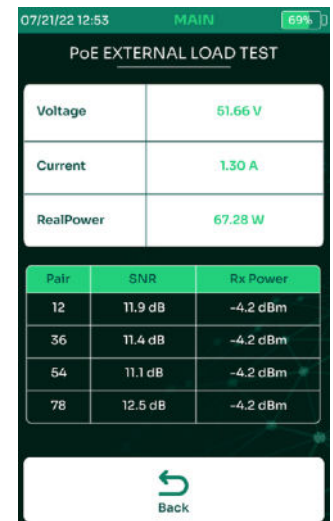
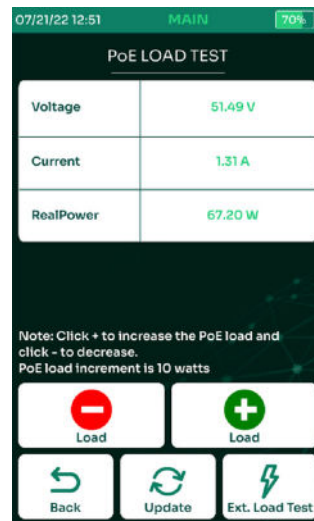
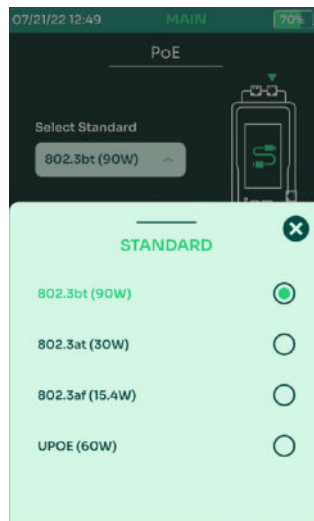
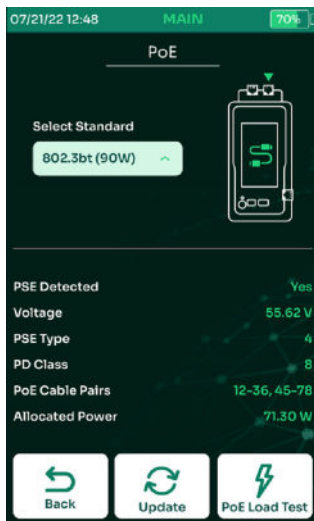



# TestDataPro - Results Management

Label	Result	Length	Worst Margin	Worst Value	Limit	Test Time	Profile	Project	Operator	Actions
1 - A-001	Pass	4.7 ft	4.49 dB (RL)	4.70 dB (NEXT)	TIA - Cat 6A Channel	8/19/2020 3:48:05 PM	Certification	2.9.R3	Default	[Icons]
2 - A-002	Fail	109.9 ft	-0.90 dB (RL)	5.90 dB (NEXT)	TIA - Cat 6A Channel	8/19/2020 3:47:34 PM	Certification	2.9.R3	Default	[Icons]
3 - A-003	Fail	159.8 ft	0.20 dB (RL)	5.90 dB (NEXT)	TIA - Cat 6A Channel	8/19/2020 3:48:04 PM	Certification	2.9.R3	Default	[Icons]
4 - A-004	Pass	100.7 ft	0.99 dB (RL)	5.90 dB (NEXT)	TIA - Cat 6A Channel	8/19/2020 3:52:19 PM	Certification	2.9.R3	Default	[Icons]
5 - A-005	Pass	140.3 ft	5.30 dB (RL)	1.00 dB (NEXT)	TIA - Cat 6A-Permanent Link	8/19/2020 3:55:03 PM	Certification	2.9.R3	Default	[Icons]
6 - A-007	Pass	9.8 ft	-	-	TIA 388.3-D MultiMode BCF Grade	8/19/2020 4:00:39 PM	Validation	2.9.R3	Default	[Icons]
7 - A-008	Pass	105.3 ft	0.66 dB (WT)	0.83 dB (WZ)	TIA 388.3-D MultiMode BCF Grade	8/19/2020 4:11:37 PM	MMA Fiber	2.9.R3	Default	[Icons]
8 - A-009	Pass	105.4 ft	0.06 dB (WT)	0.59 dB (WZ)	TIA 388.3-D SingleMode RFP STD Grade	8/19/2020 4:46:04 PM	SM Fiber	2.9.R3	Default	[Icons]
9 - SHIELD OPEN MD	Fail	95.3 ft	4.78 dB (RL)	-0.91 dB (NEXT)	TIA - Cat 6A Channel	8/19/2020 7:30:28 PM	Certification	2.9.R3	Default	[Icons]

Label	Result	Length (ft)	Test Type	Test Time	Serial No.	Profile	Operator	Test Pass	Test Report	Details
A-001	Pass	6.84	opper	Aug 19, 2020, 3:48:05 PM	40301071	Certification	Default	Download	Print	Refresh
A-002	Fail	109.90	opper	Aug 19, 2020, 3:47:34 PM	40301071	Certification	Default	Download	Print	Refresh
A-003	Fail	159.80	opper	Aug 19, 2020, 3:48:04 PM	40301071	Certification	Default	Download	Print	Refresh
A-004	Pass	100.74	opper	Aug 19, 2020, 3:52:19 PM	40301071	Certification	Default	Download	Print	Refresh
A-005	Pass	140.30	opper	Aug 19, 2020, 3:55:03 PM	40301071	Certification	Default	Download	Print	Refresh
A-007	Pass	9.84	opper	Aug 19, 2020, 4:00:39 PM	40301071	Validation	Default	Download	Print	Refresh
A-008	Pass	105.31	iber	Aug 19, 2020, 4:11:37 PM	40301071	MMA Fiber	Default	Download	Print	Refresh
A-009	Pass	105.54	iber	Aug 19, 2020, 4:46:04 PM	40301071	SM Fiber	Default	Download	Print	Refresh
SHIELD OPEN MD	Fail	95.30	opper	Aug 19, 2020, 7:30:28 PM	40301071	Certification	Default	Download	Print	Refresh

## TESTDATAPRO PC BASED

- Allows you to define projects and categorize test results into logical groupings
- Provides multiple reporting formats and options such as a single summary report or full reporting
- Allows software-based re-certification if original test was done with wrong test standard selected

## TESTDATAPRO CLOUD

- Allows immediate offload of test results to database via wired or wireless connection
- Allows visual of pass/fail results
- Allows printing of single .pdf reports

**A-004** Pass

Test Time : 8/19/2020 3:52:19 PM  
 Project : 2.9.R3

Limit : TIA - Cat 6A Channel  
 Model : TestPro CV100  
 Serial Number : Main: 4200-0071, Remote: 4200-0072  
 Certification : Device Software : 2.9.R3  
 Calibration Date : Friday, April 24, 2020  
 Main Adapter : PROBE CAT 6A CHANNEL  
 Remote Adapter : PROBE CAT 6A CHANNEL

Parameter	Result	Pair	Value	Limit
Length(ft)	Pass	78	159.7	328.1
Prop Delay(ns)	Pass	45	251.0	255.0
Delay Skew(ns)	Pass	45	15.0	50.0
DC Loop Resistance(Ω)	Pass	12	15.718	25.000
Res. Unbal, pair-pair(Ω)	Info	45-78	2.133	0.720
Res. Unbal, wire-wire(Ω)	Info	12	11.679	0.308

### RF Parameters

Parameter	Result	Main						Remote							
		Pair	Margin (dB)	Limit (dB)	Freq (MHz)	Pair	Value (dB)	Freq (MHz)	Pair	Margin (dB)	Limit (dB)	Freq (MHz)			
Return Loss	Pass	12	1.7	19.0	8.80	12	17.4	458.00	12	0.9	18.8	10.75	12	13.1	500.00
Insertion Loss	Pass	12	1.4	3.1	2.05	45	23.7	500.00	12	-	-	-	12	-	-
NEXT	Pass	36-78	2.2	32.6	268.00	36-78	31.4	480.00	36-78	1.8	29.6	373.00	12-36	30.9	470.00
PNEXT	Pass	36	4.0	29.7	287.00	36	29.3	480.00	36	2.4	26.8	367.00	36	28.5	475.00
ACRF	Pass	12-45	3.7	10.3	444.00	12-45	14.0	444.00	45-12	4.0	10.3	444.00	45-12	14.3	444.00
PSACRF	Pass	12	6.5	69.3	1.00	45	14.0	444.00	12	6.7	7.3	444.00	12	14.0	444.00
TCL	Info	12	-9.0	40.0	2.05	78	20.1	268.00	12	-9.2	40.0	2.20	12	17.8	433.00
TCLL	Info	45	-3.9	30.0	1.00	45	26.1	1.00	45	-0.5	30.0	1.00	45	22.6	29.95

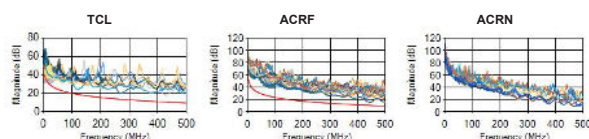
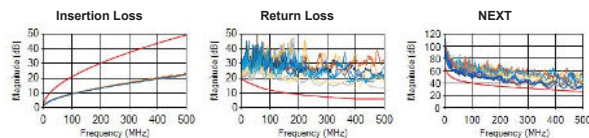

## Summary Report

### Cable Certification

Cable ID	Result	Limit	Length(ft)	Margin	Date / Time
A-002	Pass	TIA - Cat 6 Channel	109.7	1.8 dB (NEXT)	1/21/2019 2:54:10 AM
A35-A-02	Pass	TIA - Cat 6 Channel	98.3	1.7 dB (NEXT)	1/21/2019 3:02:39 AM
A-001	Pass	TIA - Cat 6 Channel	110.2	0.8 dB (NEXT)	1/21/2019 2:12:53 AM

Total Records : 3  
 Total Length : 316.2ft

### Fiber Certification

Cable ID	Result	Limit	Length(ft)	Margin	Date / Time
MM-46-A-03	Pass	Loss Budget	39.4	2.5 dB	1/22/2019 5:10:39 AM
MM-46-A-01	Pass	Loss Budget	39.4	2.6 dB	1/22/2019 4:58:22 AM
MM-46-A-04	Pass	Loss Budget	39.4	2.5 dB	1/22/2019 5:10:56 AM
SM 1	Pass	Certification	34.4	= dB	1/31/2019 3:29:54 AM
SM 2	Pass	Certification	41	0.0 dB	1/31/2019 3:34:06 AM
SM 3	Pass	Certification	41	0.0 dB	1/31/2019 3:36:14 AM

Total Records : 6  
 Total Length : 234.6ft

### Validation

Cable ID	Result	Limit	Length(ft)	Margin	Date / Time
A-001	Pass	IEEE 802.3	91.9	3.1dB	1/21/2019 2:16:19 AM
A-002	Pass	IEEE 802.3	173.9	1.7dB	1/21/2019 2:52:44 AM
Multi-Gig	Pass	IEEE 802.3	173.9	0.3dB	1/21/2019 2:49:02 AM

Total Records : 3  
 Total Length : 439.6ft

TestDataPro supports both PC and cloud-based options, and come standard with all models of TestPro. Printed test reports for copper and fiber optic include a listed of compliant network support based on the performance of the cable tested. Printed reports are provided for Copper & Fiber certification as well as the combined Multi-Gigabit/PoE Autotest. The Multi-Gigabit/PoE Autotest is a path to a new service offering you can provide to increase your revenue potential.



# Wired & Wireless Connectivity Testing

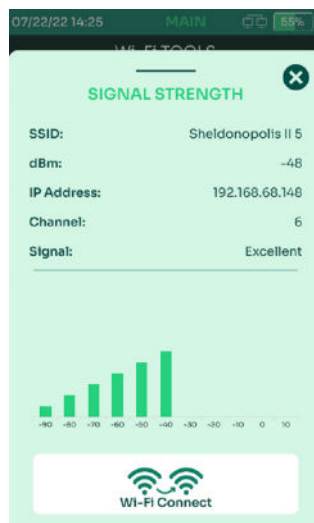
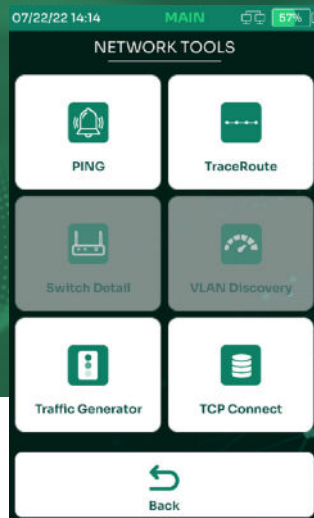

Useful for moves/adds/changes as well as general troubleshooting, TestPro will connect to a live network through the AD-NETCABLE adapter, or wireless using the optional Edimax Wi-Fi USB adapter.

## WIRED CONNECTIVITY TESTING

- Auto-discovery reports connected devices and details
- See latency and delay with Ping and Traceroute
- Understand in-depth connected switch detail including slot/port/VLAN
- See graphical breakdown of VLAN
- Traceroute and Ping troubleshooting tools
- Quick Autotest runs a suite of tests for you and provides a complete test report

## WIRELESS CONNECTIVITY TESTING

- Auto-discovery reports visible access points including channel and signal strength
- Login to access point to verify connectivity
- Check roaming signal strength
- Traceroute and Ping troubleshooting tools
- Supports 2.4 and 5GHz

Wired Network Connectivity Testing is available in the TestPro CV100 K60E, K61E Kits. This adapters is also sold separately: Model AD-NET-Cable.

Wireless Network Connectivity testing is available in all models of TestPro CV100 via the optional Edimax EW-7822ULC Dual Band MuMimo Wi-Fi USB adapter. These adapters are region specific and can be purchased on Amazon or any preferred retailer.

A handy savable Autotest function gives you the option to let the tester do all the work for you and automatically runs tests for:

- Device Information
- LAN Speed
- Network Map
- Ping Tests to your defined URLs
- Discovered Devices
- VLAN Discovery
- Switch Detail

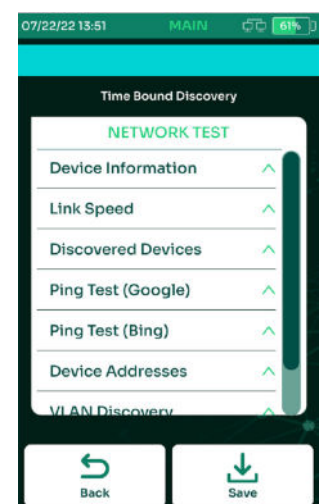



# Test Standards Compliance & Conformity



**Copper Certification** – ANSI/TIA-1152-A (Levels IIIe and 2G), IEC 61935-1 Ed. 4 (Levels IIIe and V) and IEC 61935-1 Ed. 5 Draft 46/595/CD (Levels VI Class I and Class II)



**Fiber Optic Certification** – TIA-568-C.3, TIA-568.3-D and ISO/IEC 14763-3 Ed 2.1



**Single Pair Ethernet (SPE)** – SPE Cabling Standards: TIA 568.5 (in draft), ISO/IEC TR 11801-9906-2020. SPE Field Test standards: TIA-5071 (in draft), IEC-61395-4 (in draft). IEEE Single Pair Ethernet Application standards supported: 1000BASE-T1, IEEE 802.3bp; 100BASE-T1, IEEE 802.3bw; 10BASE-T1, IEEE 802.3cg.



**Power over Ethernet** – IEEE 802.3 af/at/bt, UPoE



**Multi-Gigabit Link Speed Testing** – IEEE 802.3 up to 10GBASE-T



**Wired Network Connectivity Testing** – CDP, LLDP



**Wireless Network Connectivity Testing** – IEEE 802.11N & IEEE 802.11AC maximum wireless speed up to 300Mbps on 2.4GHz band or up to 866Mbps on 5GHz band

**Exceeds Cat 8 / Class II**  
3000MHz/3GHz platforms exceeds current standard giving you investment protection assurance for future requirements

**Hot Swappable Test Adapters**  
A variety of test adapters are available for TestPro. The most commonly used adapters are included in purpose-built kits, optional adapters allow extension of platform use.

**Touchscreen**  
Impact resistant touchscreen

**Impact Protection**  
Dense rubber housing protects test equipment and display from drops. 2 Year standard warranty protects your investment.

**Intuitive UI**  
Available test function automatically adjusts when hot swappable test adapters are swapped

**Built-in Kickstand**  
Allows for ease of use when test equipment is used in a set position

**Live Wiremap**  
The moment the remote unit is connected, TestPro gives an audible sound and shows wiremap and continuity for both copper and fiber optic

**Hot Keys**  
Quick access buttons for Autotest Initiation and Return to Home Screen

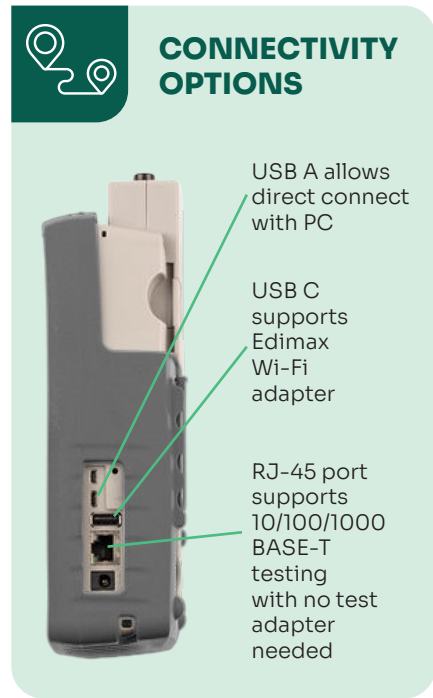
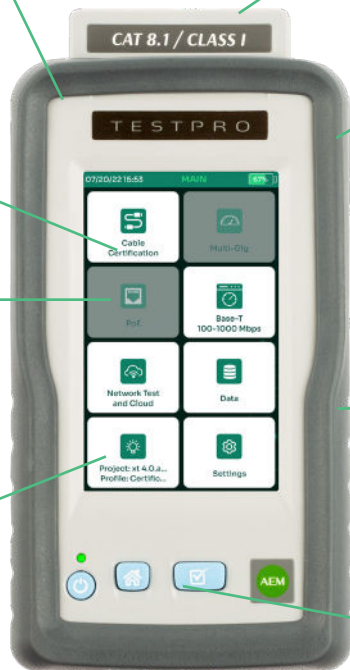

## CONNECTIVITY OPTIONS

USB A allows direct connect with PC

USB C supports Edimax Wi-Fi adapter

RJ-45 port supports 10/100/1000 BASE-T testing with no test adapter needed

# Adapters & Accessories

Part Number	Description	UOM
AD-SM-K01E	SINGLEMODE FIBER TEST KIT FOR TESTPRO	SET
AD-MM-K01E	MULTIMODE FIBER TEST KIT FOR TESTPTO	SET
AD-SPE-IEC 63171-6	SINGLE PAIR ETHERNET ADAPTER IEC 63171-6	SET
AD-M12-X	M12 X-CODED ADAPTER PAIR	SET
MM-ST-K01	TestPro ST Connector Interface Kit -MM	SET
MM-SC-K01	TestPro SC Connector Interface Kit -MM	SET
MM-FC-K01	TestPro FC Connector Interface Kit -MM	SET
SM-ST-K01	TestPro ST Connector Interface Kit -SM	SET
SM-SC-K01	TestPro SC Connector Interface Kit -SM	SET
SM-FC-K01	TestPro Fc Connector Interface Kit -SM	SET
MM-LC-CORD-K01	LC Reference Cord Kit for TestPro -MM	SET
SM-LC-CORD-K01	LC Reference Cord Kit for TestPro -SM	SET
PROBE-FIBER-INSP	FIBER INSPECTION PROBE	EA
AD-NET-CABLE	MULTIGIG AND POE ADAPTER PAIR	SET
AD-CAT6A-CH	CAT6A CHANNEL ADAPTER PAIR	SET
AD-CAT6A-PLE	CAT6A PERMENANT LINK ADAPTER PAIR	SET
AD-COAX-KIT	75 OHM COAX ADAPTER KIT	SET
ACC-6A-PL-PLUG	REPLACEABLE PLUG FOR AD-CAT6A-PL	SET
AD-5E-PCORD	CAT-5E PATCH-CORD TEST ADAPTER PAIR	SET
AD-6-PCORD	CAT-6 PATCH-CORD TEST ADAPTER PAIR	SET
AD-6A-PCORD	CAT-6A PATCH-CORD TEST ADAPTER PAIR	SET
AD-8.2-TERACH	CAT8.2 TERA CHANNEL ADAPTER PAIR	SET
AD-8.2-TERAPL	CAT8.2 TERA PERM LINK ADAPTER PAIR	SET
AD-8.2-GG45CH	CAT8.2 TERA CHANNEL ADAPTER PAIR	SET
AD-8.2-GG45PL	CAT8.2 TERA PERM LINK ADAPTER PAIR	SET
AD-COAX-KIT	Pair of Adapters for Testing Coax	SET
ACC-HARD-CASE	HARD CARRY CASE	EA
ACC-SOFT-CASE	SOFT CARRY CASE	EA
ACC-POWER-AD	AC POWER ADAPTER	EA

For more information: [www.aem-test.com](http://www.aem-test.com) | Inquiries: [sales@aem-test.com](mailto:sales@aem-test.com)

North America: AEM International (US)  
 5560 West Chandler Blvd, Suite 3, Chandler, AZ 85226 | Toll Free 833-572-6916 | 480-534-1232  
 Asia: AEM Singapore Pte. Ltd. 52 Serangoon North Ave 4 Singapore 555853  
 Revision 15/9/2021 | V.2.3

# Technical Specifications

## TESTPRO PLATFORM (All Versions)

Each platform in a kit comes with a certificate of Calibration traceable to NIST.

### SIZE

- 200mm X 105mm X 50mm
- 7.87in X 4.13in X 1.97in

### DISPLAY

- 5" TFT color touch screen, resolution 800 x 480 pixels

### BATTERY

- Li-Ion
- 3.7V / 13,200 mAh
- 9 hr battery life typical

### POWER ADAPTER

- 5V, 3A (supplied)
- 5-12V (supported)
- 2.1mm DC jack

### PLATFORM OPERATING SYSTEM

- Linux

### USB INTERFACES

- USB flash drive storage
- MicroUSB for connecting to PC

### RJ-45 SIDE PORT

- 10/100/1G network connectivity test port

### TEST ADAPTER TO PLATFORM INTERFACE

- High-frequency connector rated for 5000 insertion cycles
- Hot-swappable

### MEASUREMENT ENGINE

- 9-channel dual-ended mixed-mode RF and DC measurement engine
- Industry's highest performance patent-pending measurement architecture for data cable testing

### FREQUENCY RANGE

- 0.1 – 3,000 MHz

### COPPER TESTING (K50, K60)

#### MEASUREMENT TIME

- CAT6A auto-test (including TCL and resistance unbalance tests): 6 sec
- CAT 8 Class II auto-test: 30 sec

#### WIREMAP

- All possible wire connection situations identified, as long as two wires are connected end-to-end on any pins

#### DC RESISTANCE

- Range: 0 to 50  $\Omega$
- Pair-to-pair and within pair resistance unbalance measurement meets TIA 1152A specs

### TONE GENERATOR

- 730Hz and 1440 Hz

### DUAL-ENDED RF MEASUREMENTS IL, RL, NEXT, ACR-F, TCL

- All mandatory and optional RF measurements as per TIA and ISO/IEC standards
- Single-pair link testing license with supported length for dual ended testing greater than 1,000 m

### LENGTH (PROPAGATION DELAY) MEASUREMENT

- Dual ended test: 0 – 600m with 0.1m resolution
- (0 – 6,000 nsec with 1 nsec resolution)
- Delay skew measurement with 1 nsec resolution

### SUPPORTABLE CABLING

- 4-pair twisted pair cable
- 1-pair twisted pair cable
- Coax cable
- Optical cables (SM/MM pair)

### TDR- RL

- 0-100 m (resolution: 1 m)
- Distance-to-fault

### TDR- NEXT

- 0-100 m (resolution: 1 m)

### IMPEDANCE

- 0-1000  $\Omega$
- 0.1  $\Omega$  resolution in 90-110  $\Omega$  range

### FIBER OPTIC (K11, K51, K61)

#### COMMON TO BOTH MM AND SM

- Supplied Test Interface: interchangeable FC on TX port and interchangeable LC on RX port

#### VFL LIGHT SOURCE

- Wavelength 650nm

#### VOLTMETER

- Measurement range: 0-60V DC

#### OPTICAL POWER METER

- Measurement range: -3 dBm to -30 dBm

### SPECIFICATONS APPLICABLE TO AD-MM-01E MULTIMODE ADAPTER

#### WAVELENGTHS

- 850nm, 1300 nm

#### LIGHT SOURCE

- LED

#### TRANSMIT POWER

- 20 dBm typical

### ENCIRCLED FLUX

- Compliant to IEC- 61280-4 and TIA-526-14-C-2015 as per supplier data sheet

### LENGTH MEASUREMENT

- Range: up to 2 km (subject to maximum 10dB link loss)
- Length measurement resolution: 0.1m

### DUAL ENDED LOSS

- Dual ended loss measurement: 0 to -10 dB

### SPECIFICATIONS APPLICABLE TO AD-SM-01E SINGLEMODE ADAPTER

#### WAVELENGTHS

- 1310nm, 1550nm

#### LIGHT SOURCE

- Fabry-Perot Laser

#### OPTICAL POWER

- 2dBm typical

#### LENGTH MEASUREMENT

- Length measurement range: up to 20 km (subject to maximum 20dB link loss)
- Length measurement resolution: 0.1m

#### DUAL ENDED LOSS

- Dual ended loss measurement: 0 to -20 dB

### POWER OVER ETHERNET (K30, K60, K61)

- PoE source type detection
- Load test up to 90W
- Identification of PoE pairs
- Sustained load monitor

### MULTI-GIGABIT ETHERNET (K30, K60, K61)

#### AUTO-TEST PARAMETERS

- Signal to Noise Ratio at each speed across each pair
- Cable diagnostics
- PoE detection

#### NETWORK TESTING

- Ethernet network discovery
- Traceroute
- Traffic generator
- Ping
- Wi-Fi: Identify SSID's and measure RSSI



# TestPro Selection Guide

## Smart Building Test Kits



### Test Function

	TestPro CV100 K61E	TestPro CV100 K60E	TestPro CV100 K51E	TestPro CV100 K50E	TestPro CV100 K1E
CAT 3 - CAT 8 Channel and Permanent Link Certification with Detailed Printed Reports	✓	✓	✓	✓	✓
MM and SM Fiber Certification	✓		✓		✓
DC Resistance Unbalance	✓	✓	✓	✓	
Wiremap with Distance-to-Fault	✓	✓	✓	✓	
Hybrid Powered Fiber Voltage Test	✓		✓		✓
PoE Load and Validation Testing	✓	✓			
Multi-Gig Autotest	✓	✓			
Multi-Gig (2.5 / 5 / 10G) SNR	✓	✓			
100/1000BASE-T SNR Testing	✓	✓	✓	✓	✓
BASE-T Network Connectivity (Traceroute, Ping, etc)	✓	✓	✓	✓	✓
Wireless Network Connectivity** (AP Availability, Signal Strength, Ping, etc)	✓	✓	✓	✓	✓

\*\* Requires Edimax EW-7822ULC Wi-Fi USB Adapter purchased separately from Amazon or other component provider of your choice.

Optional test adapters available to support SPE, MPTL, Patch Cord, Coax, Bare Wire, and much more. Visit the TestPro product page on the website to learn more.