



## technical data sheet

Product code :	2011465 – 2011466 – 2011467
Description :	<b><u>PLINTHS FOR DATACENTER TECH CABINETS</u></b>

Plinths for Datacenter TECH cabinets.

CODE		DESCRIPTION	DIMENSIONS (mm)		
Gray	Black		W	D	H
2011465	2011465N	Plinths for Datacenter TECH cabinet W600xD1000	600	956	100
2011466	2011466N	Plinths for Datacenter TECH cabinet W800xD1000	800	956	100
2011467	2011467N	Plinths for Datacenter TECH cabinet W800xD1200	800	1156	100

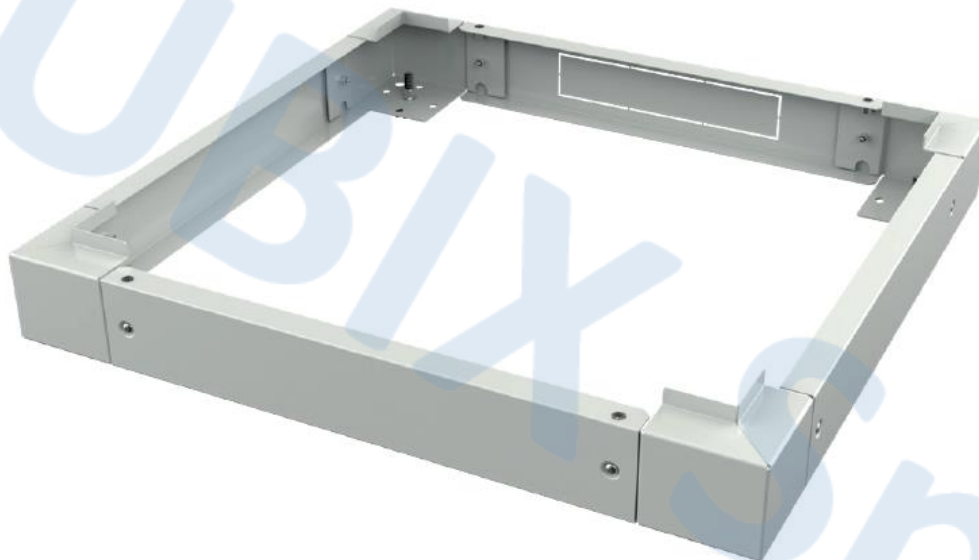

### MAIN FEATURES

- 4 removable flanges for the passage of cables
- 4 angle brackets
- Removable micro joint in the rear arranged for the installation of a cable brush
- Structure in painted steel sheet, 2 mm
- Color gray RAL 7035 or black RAL 9005
- Height 100 mm
- Mounting screws
- Predisposition for the installation of levelling feet or castors
- Load capacity: 1500 Kg (900 Kg with castors)

QUBIX S.p.A. Networking solutions – Via Canada, 22/A – 35127 Padova – Italy  
Tel. +39 049 7801994 – Fax +39 049 775667 – <http://www.qubix.it>

Rev. 01-24

Qubix S.p.A. si riserva di apportare modifiche e migliorie in qualsiasi momento senza preavviso  
Qubix S.p.A. reserves the right to make changes and improvements at any time without notice



Product code :	2011465 – 2011466 – 2011467
Description :	<b><u>PLINTHS FOR DATACENTER TECH CABINETS</u></b>

**TECHNICAL DRAWINGS**

**PLINTHS W=600**

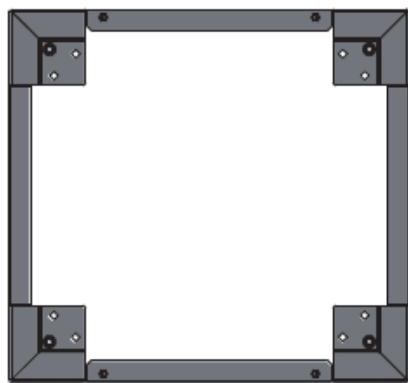
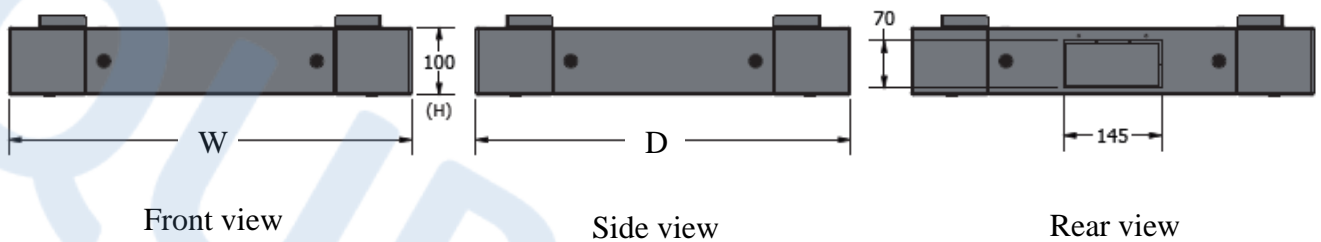

Top view

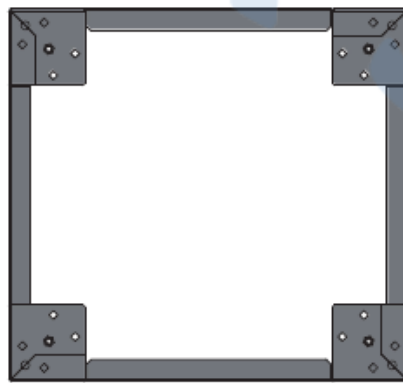

Bottom view



Product code :	2011465 – 2011466 – 2011467
Description :	<b><u>PLINTHS FOR DATACENTER TECH CABINETS</u></b>

TECHNICAL DRAWINGS

PLINTHS W=800

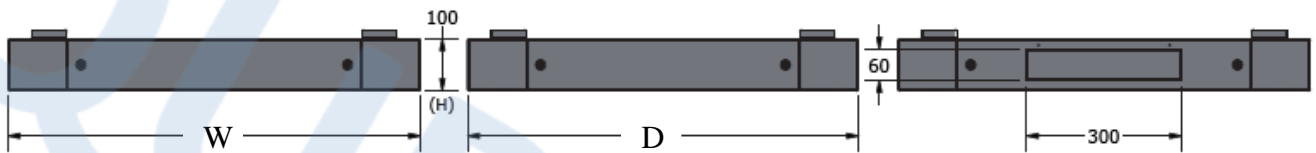

Front view

Side view

Rear view

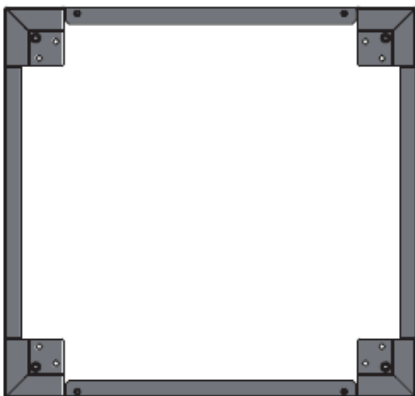

Top view

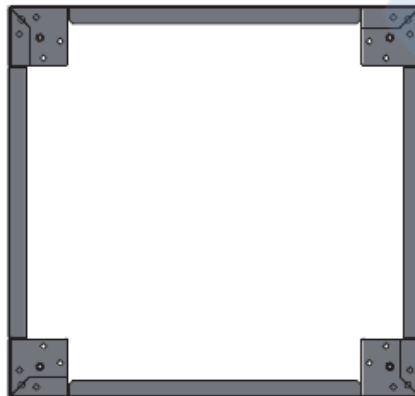

Bottom view