



# technical data sheet

Product code :	2011461 – 2011462 – 2011463 – 2011464
Description :	<b><u>PLINTHS FOR FLOOR STANDING TECH CABINETS</u></b>

Plinths for floor standing TECH cabinets.

CODE		DESCRIPTION	DIMENSIONS (mm)		
Gray	Black		W	D	H
2011461	2011461N	Plinth for floor standing TECH cabinet W600xD600	600	600	100
2011462	2011462N	Plinth for floor standing TECH cabinet W600xD800	600	800	100
2011463	2011463N	Plinth for floor standing TECH cabinet W800xD600	800	600	100
2011464	2011464N	Plinth for floor standing TECH cabinet W800xD800	800	800	100

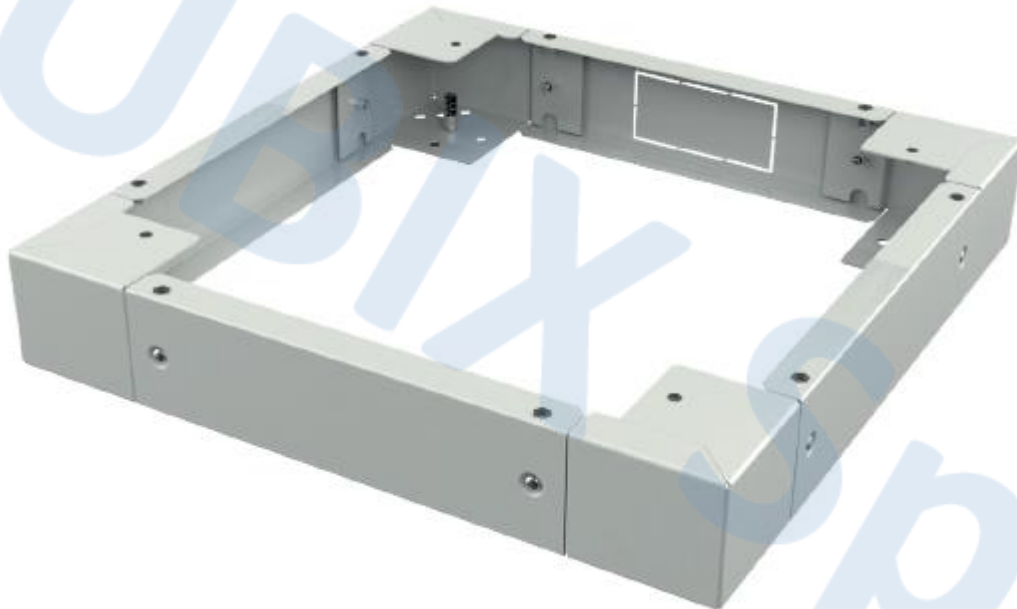

### MAIN FEATURES

- 4 removable flanges for the passage of cables
- 4 angle brackets
- Removable micro joint in the rear arranged for the installation of a cable brush
- Structure in painted steel sheet, 2 mm
- Color gray RAL 7035 or black RAL 9005
- Height 100 mm
- Mounting screws
- Predisposition for the installation of levelling feet or castors
- Load capacity: 1200 Kg (900 Kg with castors)



*technical data sheet*

Product code :	2011461 – 2011462 – 2011463 – 2011464
Description :	<b><u>PLINTHS FOR FLOOR STANDING TECH CABINETS</u></b>

**TECHNICAL DRAWINGS**

**PLINTH W=600**

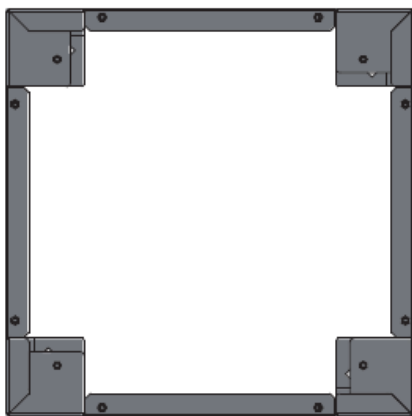
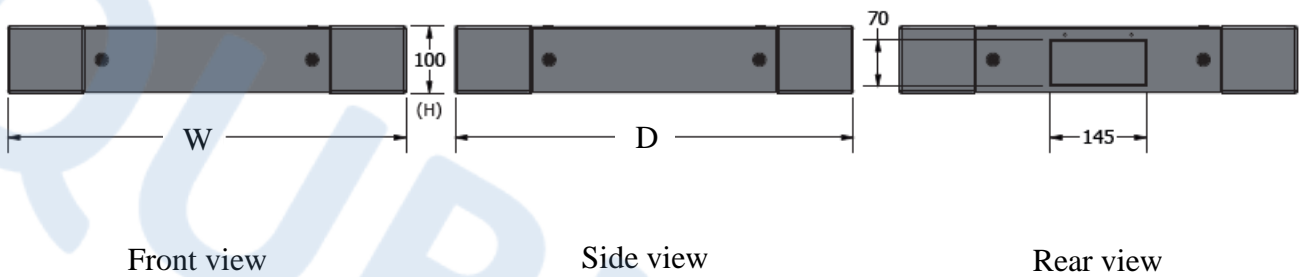

Top view

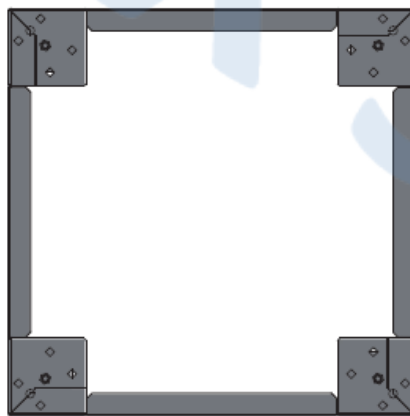

Bottom view



*technical data sheet*

Product code :	2011461 – 2011462 – 2011463 – 2011464
Description :	<b><u>PLINTHS FOR FLOOR STANDING TECH CABINETS</u></b>

*TECHNICAL DRAWINGS*

*PLINTH W=800*

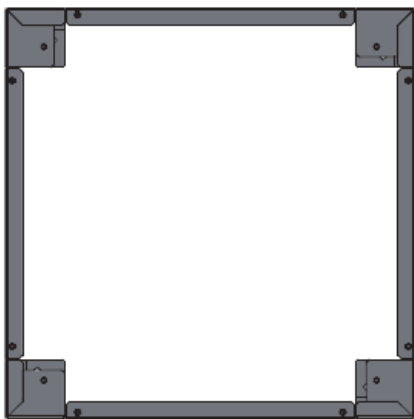
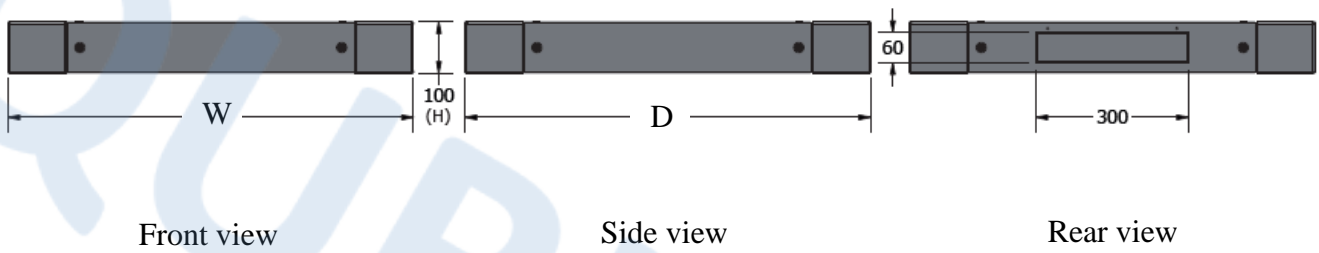

Top view

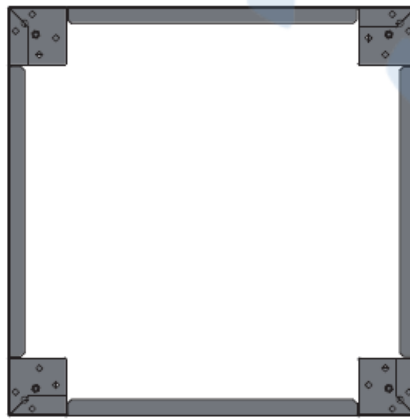

Bottom view