



CATALOGUE

STRUCTURED CABLING SYSTEM



**CONNECTIVITY
& CABLING
SYSTEM**



Copper cabling system

10

Cables	p. 13
Easy Crimp Compact system	p. 35
Easy Crimp system	p. 47
110 cabling system	p. 57
Patch cords and plugs	p. 63
Work outlet	p. 69
Industrial system	p. 77

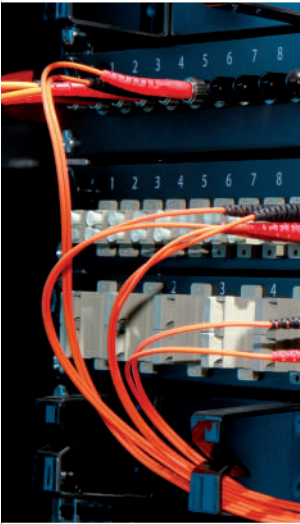

Fiber optic cabling system

86

FO cables	p. 87
Pre-terminated FO cables	p. 93
FO cabling system	p. 97
Fiber optic termination	p. 117
Fiber To The Home	p. 123



Racks and Accessories

142

Datacenter racks	p. 146
Floor racks	p. 152
Wall racks	p. 158
Small Office racks	p. 166
Accessories	p. 171

Index by article code	p. 184
-----------------------	--------

The company and the Group



>40.000 Km
OF LAN CABLES
INSTALLED EVERY YEAR

CCS® Connectivity & Cabling System develops, manufactures, and delivers copper and fiber optic solutions for specific applications in enterprise, commercial and residential environments.

Leader in Italy by market share, **CCS® Connectivity & Cabling System** is a registered trademark owned by Qubix SpA, an Italian company, supplier of copper and fiber optic structured cabling components, and networking equipments.

>20
YEARS OF
KNOW HOW

>1.100
AUTHORIZED AND CERTIFIED
INSTALLERS IN ITALY AND ABROAD



>1.950
EMPLOYEES

Hexatronic Group consists of +50 international companies with a total of +1950 employees. The headquarters are located in Sweden.

Hexatronic offers a complete range of products for passive fiber optic and copper infrastructures. The group owns 12 production facilities of fiber optic cables, micro tubes and connectivity components and it is present in Europe, North America and the Pacific area. The companies of the group work every day to improve the product range and to offer customized training programs and field support.

>730 MIO
EUR TURNOVER

12
PRODUCTION
FACILITIES

Research and development

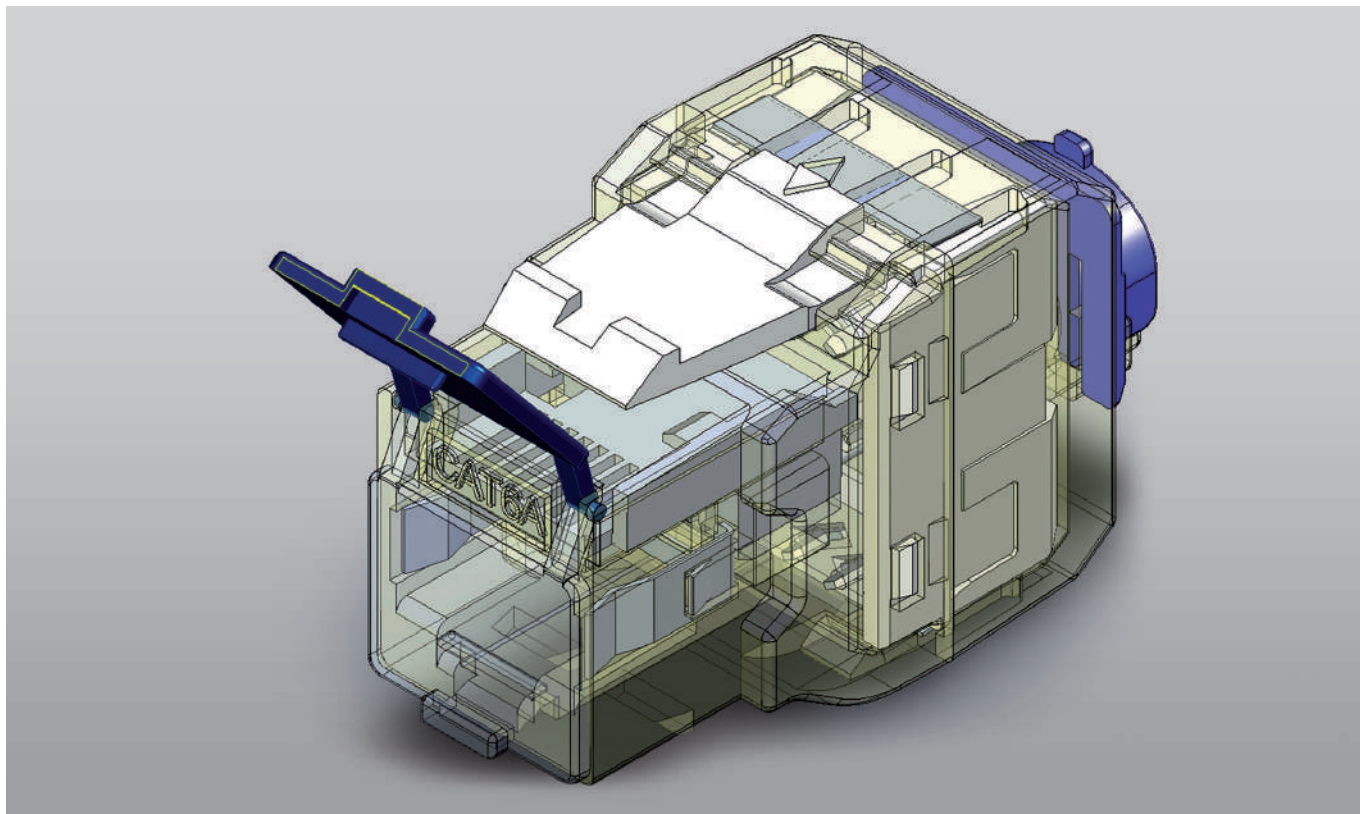

The design and development of our systems are based on a simple and efficient concept: meeting the requirements of the network professionals with products and services tailored to their needs and responding to three fundamental requirements: easy, quick and correct installation.

We are devoted to research and to develop the most innovative signal transmission cables and connecting hardware. Thanks to the membership to category associations like CEI and BICSI, we contribute to the drafting of norms, thus being always updated on the latest trends and future developments.

Quality and compliance

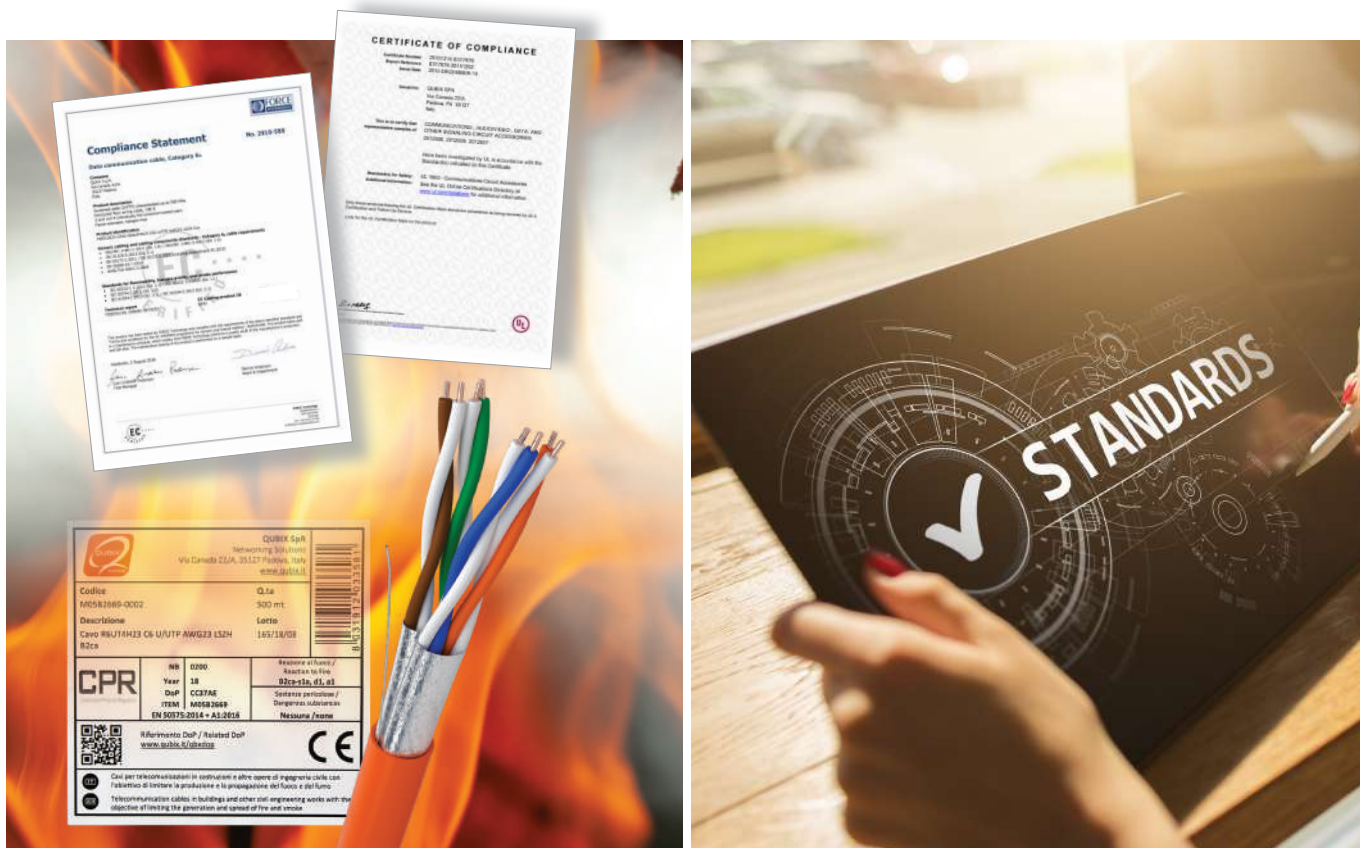

The combination of the continuous research and the high quality of our products, recognized at international level by independent accredited laboratories according to the latest international norms, are the keys to the success of the CCS® system.

Our CCS® Easy Crimp and Easy Crimp Compact cabling systems are designed to provide the best performance in terms of reliability, longevity and transmission characteristics and, at the same time, ensure easy and quick execution of the termination with significant installation cost savings.

We comply with the European directive 2012/19/EU on Waste Electrical and Electronic Equipment (WEEE).



Certified by Notified Bodies according to the norms ISO/IEC 11801, ANSI/TIA 568 and EN 50173, CCS® cables are compliant with CPR Directive (UE/305/2011) that defines, with the different Euroclasses, the performance to fire production, opacity, acidity and corrosiveness of smokes and flaming droplets that can propagate fire. All CCS® cables are available on stock and are labelled according to the Directive of the European Regulation for Construction Products (CPR).

Efficient logistics



The 3500 square meters warehouse and goods readily available allow us to offer a prompt delivery service for 80% of the articles. Warehouse lay-out managed by a computerized system together with optimized goods handling and identification grant a great logistics service.

Our Shipping Department offers support and optimized solutions to our customers for the organization of their shipments.

3.500
SQM
OF WAREHOUSE

80%
OF CATALOGUE PRODUCTS
ON STOCK

24/48
HOURS FOR ORDER
PROCESSING AND DELIVERY

Partnership program



Our sales philosophy is based on long-term partnerships with our customers.

CCS® GOLD and **SILVER** distribution partners have several benefits according to their distribution class/contract and take advantage of marketing and technical support, preferential pricing, pre-and post-sales training. We don't just supply products, we provide added value to our partners by offering services and know-how that allow them to be market leaders.

A specific training course program is offered to our Accredited Partners and therefore acquire best knowledge of the CCS® cabling systems.



WE ARE PRESENT IN
>20
COUNTRIES IN THE EMEA REGION

Technical support *service*



Our technical support service is carried out by a team of engineers and is at our customers' disposal to offer personalized support during the design and installation phases as well as advice and assistance with technical clarifications regarding selection and installation of our products.

A dedicated download centre at:

www.ccs-cabling.it

gives you quick access to useful documents like data-sheets, certificates and tutorial videos. You can follow us also on social media like LinkedIn, Facebook and YouTube to be always updated on our latest news and events. Always at your side, our Marketing Department supports you with catalogues, brochures and sample kits and provides assistance to the events organized by our partners.

Training and warranty



CCS® offers qualified training courses on copper, fiber optic and FTTx systems to become CCS® Accredited Installer. The courses are held by our engineers in our Qubix Academy Space and offer theoretical and practical knowledge. Webinars are also organized on a regular base.

CCS® Warranty covers the performances on the application designed to operate over the installed classes of the cabling systems in accordance with the ISO/IEC 11801, ANSI/TIA 568 and EN 50173 international standards. They must exclusively be designed, realized and installed by Accredited CCS® installers who use full CCS® branded connecting hardware and cables and have followed CCS® Warranty procedures.

30 YEARS
WARRANTY

>450 HOURS
DEDICATED TO TECHNICAL
TRAINING OF OUR PARTNERS

1.100
ACCREDITED
INSTALLERS



Copper cabling system



Complete solution of copper structured cabling system branded CCS®, including copper cables, cabling components and accessories.

Performance, reliability and easy installation are the main characteristics and advantages of the system designed and realized to comply with the requirements of ISO/IEC 11801, EN 50173, ANSI/TIA 568 international standards.

The certifications issued by independent laboratories and the Warranty up to 30 years guarantee the maximum performances in terms of reliability and quality.

<i>Cables</i>	<i>p. 13</i>
<i>Easy Crimp Compact system</i>	<i>p. 35</i>
<i>Easy Crimp system</i>	<i>p. 47</i>
<i>110 cabling system</i>	<i>p. 57</i>
<i>Patch cords and plugs</i>	<i>p. 63</i>
<i>Work outlet</i>	<i>p. 69</i>
<i>Industrial system</i>	<i>p. 77</i>

Copper cabling system – Cabling solutions

	EASY CRIMP COMPACT <i>Enterprise</i>	EASY CRIMP <i>Commercial</i>	110 SYSTEM <i>Residential</i>
--	--	--	---

Toolless	●	●	○
Category 5E UTP component	○	●	●
Category 5E STP component	○	●	●
Category 6 UTP component	●	●	●
Category 6 STP component	○	●	●
Category 6 _A UTP component	●	○	○
Category 6 _A STP component	●	○	○
Category 6A UTP channel	○	●	○
Category 6A STP channel	●	●	○
Certified by independent laboratory	●	●	●
Warranty on the performance up to 25 years	●	●	○
Warranty on the performance up to 30 years	●	○	○
Qualified for PoE	●	●	●
Qualified for PoE+/PoE++	●	●	○
High density	●	○	○
Keystone	●	●	●

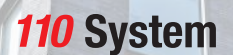
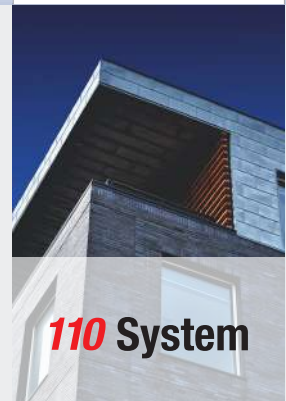

For networks of new generation up to 10 Gigabit and high density installations, the series Easy Crimp Compact grants high performances, efficiency and reduced dimensions of the components. Totally toolless, this series allows for a quick and easy termination without the use of any termination tool.

Easy Crimp is CCS® cabling solution for the networks of commercial buildings. The unique termination system so much appreciated by installers is simple and quick and it grants an immediate benefit in terms of total cost of the system. It supports PoE++ installations till 90W and suitable from 1G to 10G Ethernet.

Suitable for cabling systems with speed of 1G and PoE applications up to 15,4W, the 110 system can be used in residential buildings with a limited number of links. The termination is performed through an impact tool on a IDC110 termination type.

Copper cabling system – Fields of application

ENTERPRISE



RJ45 JACK
EASY CRIMP COMPACT



HIGH DENSITY PATCH PANEL



PLUG EASY CRIMP COMPACT

COMMERCIAL



RJ45 JACK EASY CRIMP



PATCH PANEL EASY CRIMP



PLUG EASY CRIMP

RESIDENTIAL



RJ45 JACK 110 SYSTEM



PATCH PANEL 110
PRETERMINATED



PLUGS

Designing a copper cabling system, it is fundamental to properly evaluate the field of application and the installation environment. For Enterprise settings like Datacenter, IT rooms, hospitals or universities, the Easy Crimp Compact system is the ideal solution for the ease of use and the compact dimension of the components.

In commercial environments like schools, offices or shops where it is asked a high-speed and reliable connectivity, the Easy Crimp range of products can offer wide infrastructure solutions. For the residential cabling the 110 system solution is still a highly used system.

Copper cabling system – Cables

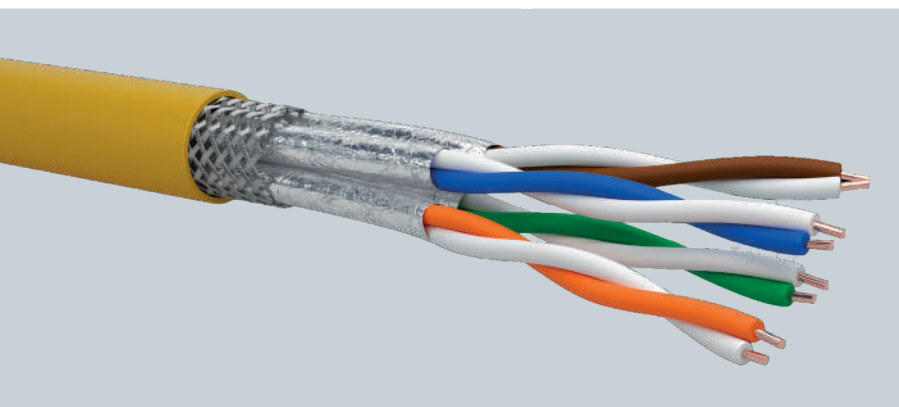
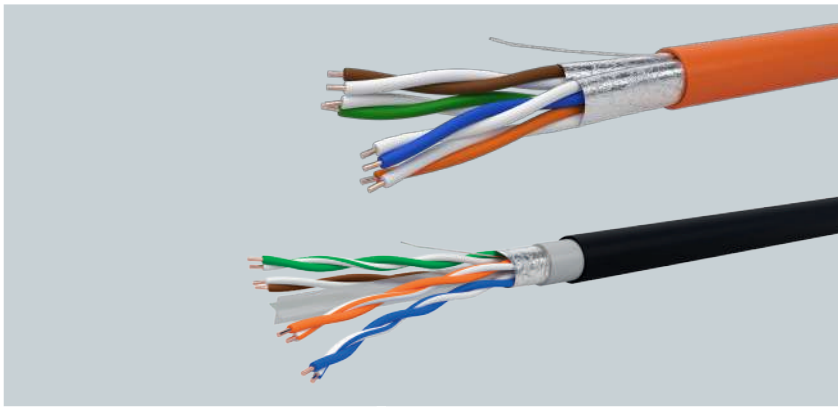

Cables

The wide range of cables branded CCS® includes products suitable for data, video and phone signals transmission according to the latest transmissive protocols with constructive solutions suitable to the installation in harsh environments.

CAT 5E, 6, 6A, 6A, 7, 7A cables are certified by independent laboratories according to ISO/IEC 11801, EN 50173, ANSI/TIA 568 international reference standards.

CPR compliance	p. 14
Cable construction	p. 16
Category 7 _A and 7	p. 17
Category 6 _A	p. 19
Category 6	p. 26
Category 5E	p. 29
Outdoor cables	p. 32

CPR - CONSTRUCTION PRODUCTS REGULATION



CPR is a European Regulation (EU/ 305/2011) effective from 2017 setting the conditions for the sale of construction products and for the use of the CE marking, defining METHODS AND CRITERIA to classify construction products according to their fire behaviour (Euroclasses) including communication cables, both copper and fiber optic.

According to the reaction-to-fire performances there are 7 EUROCLASSES followed by the acronym “ca” subscript (cable) with growing performances. Each Euroclass defines minimum requirements for heat release and flame propagation specifying also additional criteria:

	EUROCLASS	DESCRIPTION	INSTALLATION ENVIRONMENTS *
HIGH PERFORMANCE		Very low reaction to fire	Buildings with high crowd density and difficult access to escape routes and/or very high risk for goods/equipments. Example: road/train galleries, very high buildings open to public like hotels, hospitals, retirement houses.
		Low reaction to fire	Buildings with high crowd density and easy access to escape routes and/or high risk for goods/equipments. Example: theatres, cinemas, malls
		Moderate reaction to fire	Basic Euroclass for generic installations in some countries
BASIC PERFORMANCE		Basic reaction to fire	Basic Euroclass for generic installations in some countries
FLAMMABLE		Undetermined reaction to fire	Basic Euroclass for generic installations in some countries

It is up to the EU member states to define the fire reaction class in relation with the installation environment.

ADDITIONAL CRITERIA SPECIFICATIONS FOR EUROCLASS Dca - Cca - B2ca



S - SMOKE

release and opacity of smoke (s1, s2, s3)
s1 little smoke production and low smoke propagation
s1a s1 plus transmittance value according to en 61034-2 ≥ 80%
s1b s1 plus transmittance value according to en 61034-2 ≥ 60% and < 80%
s2 moderate smoke production and propagation
s3 potentially strong smoke production and propagation



d - FLAMING DROPLETS

dropping of flaming particles that can propagate fire (d0, d1, d2)
d0 no flaming droplets
d1 no flaming droplets that last more than 10 seconds
d2 potentially long-lasting flaming droplets



a - ACIDITY

emission of acid gases during the fire (a1, a2, a3)
a1 slightly acid smokes
a2 moderately acid smokes
a3 potentially high acid smokes

*Ref. CEI UNEL 35016-2022

	CODE	CABLE DESCRIPTION	EUROCLASS				
			F _{ca}	E _{ca}	D _{ca}	C _{ca}	B2 _{ca}
CATEGORY 5E	M0502057	CPR 6707 U/UTP CAT. 5E AWG24 - unshielded - PVC		●			
	M0502091	CPR 6707 U/UTP CAT. 5E AWG24 - unshielded - LSZH		●			
	M0502077	CPR 6727 F/UTP CAT. 5E AWG24 - shielded - PVC		●			
	M0502098	CPR 6727 F/UTP CAT. 5E AWG24 - shielded - LSZH		●			
	M0502085	CPR 6727-C SF/UTP CAT. 5E AWG24 - shielded - LSZH		●			
	M0502100	CPR 6709 U/UTP CAT. 5E AWG24 - unshielded - PVC/PE Outdoor	●				
CATEGORY 6	M0502701	R6UT4H24 U/UTP CAT. 6 AWG24 - unshielded - LSZH		●			
	M05D2701	R6UT4H24 U/UTP CAT. 6 AWG24 - unshielded - LSZH			●		
	M05C2701	R6UT4H24 U/UTP CAT. 6 AWG24 - unshielded - LSZH				●	
	M0502820	R6UT4Y23 U/UTP CAT. 6 AWG23 - unshielded - PVC		●			
	M0502669	R6UT4H23 U/UTP CAT. 6 AWG23 - unshielded - LSZH		●			
	M05D2669	R6UT4H23 U/UTP CAT. 6 AWG23 - unshielded - LSZH			●		
	M05B2669	R6UT4H23 U/UTP CAT. 6 AWG23 - unshielded - LSZH					●
	M0502668	R6FT4H23 F/UTP CAT. 6 AWG23 - shielded - LSZH		●			
	M0502200	R6UT4YPE23 U/UTP CAT. 6 AWG23 - unshielded - PVC/PE Outdoor	●				
	M0502201	R6FT4YPE23 F/UTP CAT. 6 AWG23 - shielded - PVC/PE Outdoor	●				
CATEGORY 6A	M0502831	R6A-UT4H23 U/UTP CAT. 6A AWG23 - unshielded - LSZH		●			
	M05B2833	R6A+ UT4H23 U/UTP CAT. 6A AWG23 - unshielded - LSZH					●
	M05B2834	R6A+UT4H23 U/UTP CAT. 6A AWG 23 - unshielded - LSZH					●
	M0502832	R6A-FT4H23 F/UTP CAT. 6A AWG23 - shielded - LSZH		●			
	M05C2823	R6A-UF4H23 U/FTP CAT. 6A AWG23 - shielded - FR-LSZH				●	
	M05D2826	R6A-UF4H23 U/FTP CAT. 6A AWG23 - shielded - FR-LSZH			●		
	M05D2825	R6A-FF4H23 F/FTP CAT. 6A AWG23 - shielded - FR-LSZH			●		
CAT. 7-7A	M05C2710	R7ST4H23S S/FTP CAT. 7 AWG23 - shielded - FR-LSZH				●	
	M05B2711	R7AST4H23 S/FTP CAT. 7A AWG23 - shielded - FR-LSZH					●

DECLARATION OF PERFORMANCE (DOP)

The Declaration of Performance (DoP), is the official document where the manufacturer identifies the product, describes the performance in relation to its essential characteristics such as fire reaction according to EN 50575 and emission of harmful substances based on the Euroclass of the product itself.

HOW TO GET THE DoP

All CCS cables packagings - reels or boxes bear a QR code on the label. Scanning this code you will be directed to a web page where you can download the DoP of the requested product.



U/UTP

Unscreened on the single pairs

Unscreened on the overall

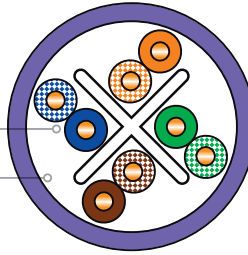

F/UTP

Unscreened on the single pairs

Foil screen on the overall

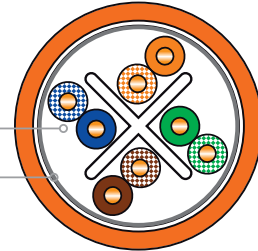

U/FTP

Foil screen on the single pairs

Unscreened on the overall

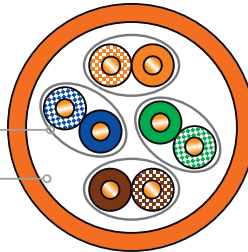

F/FTP

Foil screen on the single pairs

Foil screen on the overall

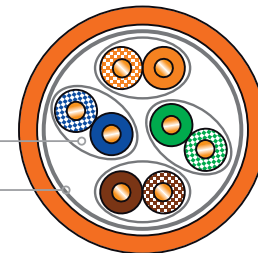

SF/UTP

Unscreened on the single pairs

Braid + foil screen on the overall

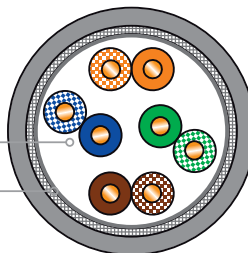

S/FTP PiMF

Foil screen on the single pairs

Braid screen on the overall

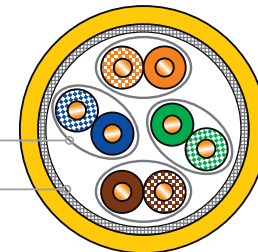

According to ISO/IEC 11801 standards, the first letter of the acronym refers to the global screening, while the second letter describes the screening of the single pairs. TP means twisted pairs.

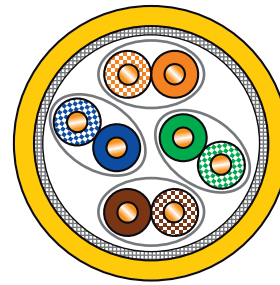
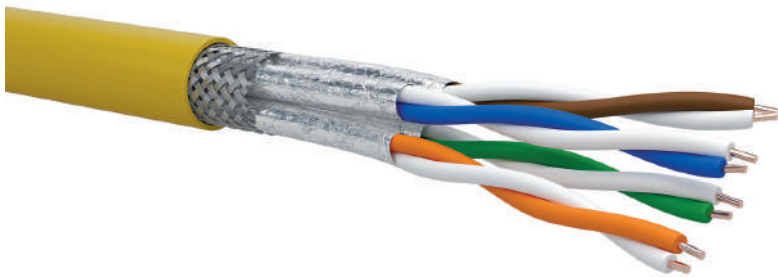

R7AST4H23 S/FTP PIMF

S/FTP CAT 7_A, 4-pair cable (100 Ohm) PiMF with each pair shielded with AL/Mylar tape and overall tinned copper braid, FR LSZH (Low Smoke Zero Halogen) flame and fire retardant jacket, tested up to 1 GHz. Ideal for the realization of transmission channels of Class Fa.

Applications and performance

Cable suitable for the realization of generic cabling systems according to EN 50173; ISO/IEC 11801.

Ideal for indoor applications in Class D, E, EA, F and FA over 10 GbE on IEEE 802.3an, PoE/PoE+/ PoE++ protocols. Electrical characteristics exceed Category 7_A requirements.

Reference standards

Data transmission cables of Category 7_A according to ISO/IEC 11801; IEC 61156-5; EN 50173-1.

Construction characteristics

Inner conductors - material/diameter	Solid bare copper/AWG 23/1 (0,58mm)
Insulation - material/diameter	Foam skin PE max. diam. 1,35
Pair Shield	Al/Mylar tape
Overall shield	Tinned copper wire braid
Cable diameter	7,8 ± 0,5 mm
Outer jacket - material/color	LSZH/Yellow RAL 1021
Lead-free	Yes
Cable weight	63 kg/Km

Suitable for 10 Gigabit Ethernet
Tested up to 1 GHz



Mechanical and environmental properties

Use	Indoor
Bend. radius during installation	8 x outer diameter
Bend. radius after installation	4 x outer diameter
Max pull strength	110 N (11 kg max.)
Installation temperature	From 0°C to +50°C
Operating temperature	From -10°C to +60°C

Fire behaviour

CPR Regulation	EN 50575
Fire behaviour	EN 50399
	EN 60332-1-2; CEI 20-35/1-2
Acid gas emission	EN 60754-2; CEI 20-37/2-2
Smoke density	EN 61034-2; CEI 20-37/3-1

Electrical properties at 20°C

DC loop cond. resistance	Max 18,6 Ohm/100m
Insulation resistance	5 GOhm x km
Max. capacitance unbalance	3300 pF/km
NVP nominal velocity of propagation	74%
Max. propagation delay	570 ns/100m
Characteristic impedance	100 ± 5 Ohm @ 100MHz

*according to EN 50288-9-1, IEC 61156-5(2012)

ELECTRIC CHARACTERISTICS ACCORDING TO FREQUENCY

Freq MHz	Attenuation dB/100m		NEXT dB		PS-NEXT dB		ACR dB@100m		PS-ACR dB@100m		ACR-F dB@100m		RL dB	
	max.*	Typ.	min.*	Typ.	min.*	Typ.	min.*	Typ.	min.*	Typ.	min.*	Typ.	min.*	Typ.
1	2.1	1.9	80	105	77	102	77.9	103	75	100	80	95	23	25
10	5.8	5.5	80	105	77	102	74.2	99.5	71.2	96.5	75	92	25	30
62.5	14.6	13	78	101	75.5	99	63.4	88	60.9	86	59.5	80	21.5	31
100	18.5	17.6	74	100	72.4	97	55.5	82.4	53.9	79.4	55.3	76	20.1	33
200	26.5	25.3	70.8	93	68	90	44.3	67.7	41.5	64.7	49.7	70	18	29
500	42.8	40.4	65	85	61.9	82	22.2	44.6	19.1	41.6	41.8	60	17.3	24
600	47.1	44.9	63.7	81	60.7	78	16.6	36.1	13.6	33.1	39.8	58	17.3	23
700	51.1	49	62.7	79	59.7	75	11.6	30	8.6	26	38.4	50	14.2	21
1000	61.9	58.5	60.4	74	57.4	71	-1.5	15.5	-4.5	12.5	35.3	43	13.1	19

Code	Description	Euroclass	Packaging
M05B2711	R7AST4H23 S/FTP CAT7A 4x2xAWG23/1 - shielded - LSZH	B2ca s1a,d1,a1	1000 mt

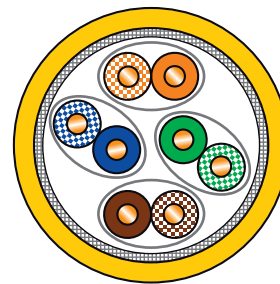
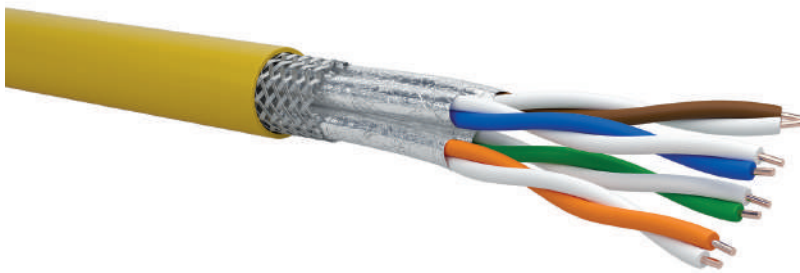

R7ST4H23S S/FTP PIMF

Suitable for 10 Gigabit Ethernet
Tested up to 1 GHz



S/FTP CAT 7, 4-pair cable (100 Ohm) PiMF with each pair shielded with AL/PET tape and overall tinned copper braid, FR LSZH (Low Smoke Zero Halogen) flame and fire retardant jacket, tested up to 1 GHz. Ideal for the realization of transmission channels of Class F.

Applications and performance

Cable suitable for the realization of generic cabling systems according to EN 50173; ISO/IEC 11801.

Ideal for indoor applications in Class D, E, EA and F over 10 GbE on IEEE 802.3an, PoE/PoE+/ PoE++ protocols. Electrical characteristics exceed Category 7 requirements.

Reference standards

Data transmission cable of Category 7 according to ISO/IEC 11801; IEC 61156-5; EN 50173-1.

Construction characteristics

Inner conductors - material/diameter	Solid bare copper/AWG 23/1 (0,58mm)
Insulation - material/diameter	Foam skin PE max. diam. 1,35
Pair Shield	Al/PET tape
Overall shield	Tinned copper wire braid
Cable diameter	7,8 ± 0,3 mm
Outer jacket - material/color	LSZH/Yellow RAL 1021
Lead-free	Yes
Cable weight	64 kg/Km

Mechanical and environmental properties

Use	Indoor
Bend. radius during installation	8 x outer diameter
Bend. radius after installation	4 x outer diameter
Max pull strength	110 N (11 kg max.)
Installation temperature	From 0°C to +50°C
Operating temperature	From -10°C to +60°C

Fire behaviour

CPR Regulation	EN 50575
Fire behaviour	EN 50399 EN 60332-1-2; CEI 20-35/1-2
Acid gas emission	EN 60754-2; CEI 20-37/2-2
Smoke density	EN 61034-2; CEI 20-37/3-1

Electrical properties at 20°C

DC loop cond. resistance	Max 18,6 Ohm/100m
Insulation resistance	5 GOhm x km
Max. capacitance unbalance	3300 pF/km
NVP nominal velocity of propagation	74%
Max. propagation delay	534 ns/100m
Characteristic impedance	100 ± 5 Ohm @ 100MHz

*according to EN 50288-4-1 (2013), IEC 61156-5(2012)

ELECTRIC CHARACTERISTICS ACCORDING TO FREQUENCY

Freq MHz	Attenuation		NEXT		PS-NEXT		ACR		PS-ACR		ACR-F		RL	
	dB@100m		dB		dB		dB@100m		dB@100m		dB@100m		dB	
	max.*	Typ.	min.*	Typ.	min.*	Typ.	min.*	Typ.	min.*	Typ.	min.*	Typ.	min.*	Typ.
1	2.0	1.9	80	105	77	102	78	103	75	100	80	95	23	25
10	5.9	5.5	80	105	77	102	74	99	71	96	74	92	25	30
100	19	17.6	72	100	69	97	53	82	50	79	54	76	20.1	33
200	27.5	25.3	68	93	65	90	40	68	37	65	48	70	18	29
500	45.3	40.4	62	85	59	82	17	45	14	42	40	60	17.3	24
600	50.1	44.9	61	81	58	78	11	36	8	33	38	58	17.3	23
800	-	51.5	-	79	-	75	-	26	-	23	-	50	-	21
900	-	56.9	-	76	-	73	-	19	-	16	-	46	-	20
1000	-	59.5	-	74	-	71	-	14	-	11	-	43	-	19

Code	Description	Euroclass	Packaging
M05C2710	R7ST4H23S S/FTP CAT7 4x2xAWG23/1 - shielded - LSZH	Cca s1a,d1,a1	1000 mt

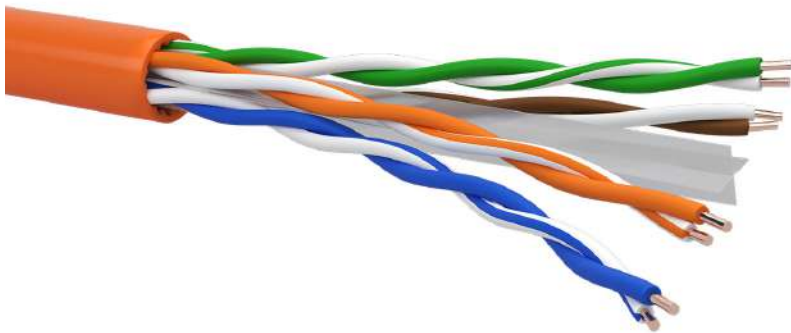

R6A-UT4H23 U/UTP

Suitable for 10 Gigabit Ethernet
Tested up to 600 MHz



U/UTP CAT6A unshielded 4-pair cable (100 Ohm) with cross separator, LSZH (Low Smoke Zero Halogen) flame retardant jacket, tested up to 600 MHz. Suitable for the realization of 3rd generation transmission channels of Class EA.

Applications and performance

Cable suitable for the realization of generic cabling systems according to EN 50173; ISO/IEC 11801.

Ideal for indoor applications in Class D, E and EA up to 10 GbE over IEEE 802.3an and PoE/PoE+/PoE++ protocols. Electrical characteristics exceed Category 6_A requirements.

Reference standards

Data transmission cables of Category 6_A according to ISO/IEC 11801; IEC 61156-5; EN 50173-1; ANSI/TIA-568.2-D (not including cable alien crosstalk parameters PS ANEXT and PS AACR-F).

Construction characteristics

Inner conductors - material/diameter	Solid bare copper/AWG23/1(0,57mm)
Insulation - material/diameter	Solid PE max diam. 1,0 mm
Cable diameter	6,6 ± 0,3 mm
Outer jacket - material/color	LSZH/Orange RAL 2003
Lead-free	Yes
Cable weight	45 kg/Km

Mechanical and environmental properties

Use	Indoor
Bend. radius during installation	8 x outer diameter
Bend. radius after installation	4 x outer diameter
Max pull strength	110 N (11kg max.)
Installation temperature	From 0°C to +50°C
Operating temperature	From -10°C to +60°C

Fire behaviour

CPR Regulation	EN 50575
Fire behaviour	EN 60332-1-2; CEI 20-35/1-2
Acid gas emission	EN 60754-2; CEI 20-37/2-2
Smoke density	EN 61034-2; CEI 20-37/3-1

Electrical characteristics at 20°C

DC loop cond. resistance	17 Ohm/100m
Insulation resistance	5 GOhm x km
Mutual capacitance	56 pF/m
Capacitance unbalance	3300 pF/km
NVP nominal velocity of propagation	67%
Max. propagation delay	534 ns/100m
Characteristic impedance	100 ± 15 Ohm

*according to EN 50288-11-1 (2013), IEC 61156-5(2012)

ELECTRICAL CHARACTERISTICS ACCORDING TO FREQUENCY

Freq MHz	Attenuation		NEXT		PS-NEXT		ACR		PS-ACR		ACR-F		PS-ACR-F		RL	
	max.*	Typ.	min.*	Typ.	min.*	Typ.	min.*	Typ.	min.*	Typ.	min.*	Typ.	min.*	Typ.	min.*	Typ.
1	2.1	1.9	75.3	95	72.3	92	73.2	93.1	70.2	90.1	68	88	65	83	-	25
10	5.9	5.5	60.3	80	57.3	76	54.4	74.5	51.4	70.5	48	72	45	66	25	36
100	19.1	17.6	45.3	65	42.3	58	26.2	47.4	23.2	40.4	28	55	25	44	20.1	34
200	27.6	25.6	40.8	63	37.8	56	13.2	37.4	10.2	30.4	22	50	19	36	18	33
250	31.1	28.3	39.3	62	36.3	55	8.3	33.7	5.3	26.7	20	48	17	35	17.3	32
300	34.3	31.1	38.1	61	35.1	53	3.9	29.9	0.9	21.9	18.5	46	15.5	34	17.3	31
450	42.7	38.2	35.5	59	32.5	51	-7.2	20.8	-10.2	12.8	14.9	42	11.9	32	17.3	29
500	45.3	40.5	34.8	57	31.8	49	-10.4	16.5	-13.4	8.5	14	40	11	30	17.3	28
600	-	44.4	-	55	-	48	-	10.6	-	3.6	-	38	-	29	-	26

Code	Description	Euroclass	Packaging
M0502831	R6A-UT4H23 U/UTP CAT6A 4x2xAWG23/1 - unshielded - LSZH	Eca	500 mt

Cables

Category 6_A

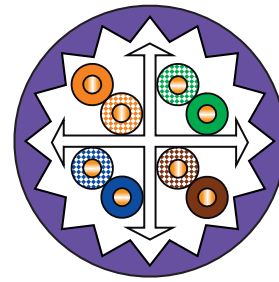
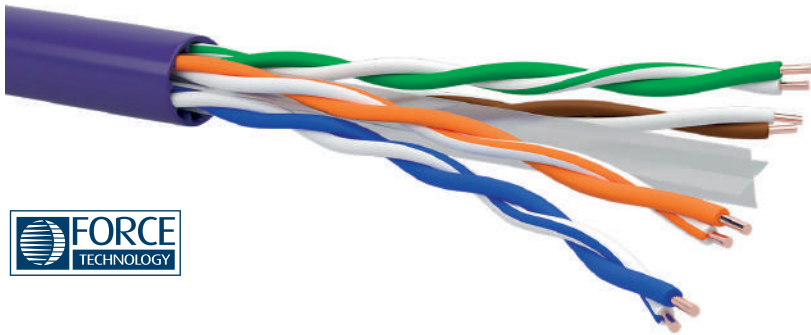

R6A* UT4H23 U/UTP

U/UTP CAT6_A unshielded 4-pair cable (100 Ohm) with cross separator, LSZH (Low Smoke Zero Halogen) flame and fire retardant jacket, tested up to 500 MHz. Suitable for the realization of 3rd generation horizontal cabling of Class E_A.

Applications and performance

Cable suitable for the realization of generic cabling system according to EN 50173; ISO/IEC 11801. Ideal for indoor applications in Class D, E and E_A up to 10 GbE over IEEE 802.3an and PoE/PoE+/PoE++ protocols. Electrical characteristics exceed CAT. 6_A requirements.

Reference standards

Force Technology approval for data transmission cables of Category 6_A according to ISO/IEC 11801-1/2:2017; IEC 61156-5:2020 Ed.3; EN 50173-1/2:2018; EN 50288-11-1: 2012; ANSI/TIA-568-2.D, Alien crosstalk PS ANEXT and PS AACR-F parameters included.

Construction characteristics

Inner conductors - material/diameter	Solid bare copper/AWG 23/1 (0,57 mm)
Insulation - material/diameter	Solid PE max diam. 1,09 mm
Cable diameter	8,2 ± 0,3 mm
Outer jacket material/colour	LSZH/Violet RAL 4005
Lead free	Yes
Cable weight	60 kg/km

Suitable for 10 Gigabit Ethernet
Tested up 500 MHz



Mechanical and environmental properties

Use	Indoor
Bend.radius during instalation	8 x outer diameter
Bend.radius after installation	4 x outer diameter
Max pull strength	110 N (11kg max.)
Installation temperature	from -10°C to +60°C
Operating temperature	from -10°C to +60°C

Fire behaviour

CPR Regulation	EN 50575
Fire behaviour	EN 50399
	EN 60332-1-2; CEI 20-35/1-2
Acid gas emission	EN 60754-2; CEI 20-37/2-2
Smoke density	EN 61034-2; CEI 20-37/3-1

Electrical characteristics at 20°C

DC loop conductor resistance	19 Ohm/100m
Insulation resistance	5 GOhm x km
Mutual capacitance	50 pF/m
Capacitance unbalance	1600 pF/km
NVP nominal velocity of propagation	66,7%
Max. propagation delay	534 ns/100m
Characteristic impedance	100 ± 15 Ohm

*according to EN 50288-11-1 (2012), IEC 61156-5(2012)

ELECTRIC CHARACTERISTICS ACCORDING TO FREQUENCY

Freq MHz	Attenuation dB@100m		NEXT dB		PS-NEXT dB		ACR dB@100m		PS-ACR dB@100m		ACR-F dB@100m		PS-ACR-F dB@100m		RL dB	
	max.*	Typ.	min.*	Typ.	min.*	Typ.	min.*	Typ.	min.*	Typ.	min.*	Typ.	min.*	Typ.	min.*	Typ.
1	2.1	1.8	75.3	100	72.3	98	73.2	98.2	70.2	96.2	68	101	65	88	-	31
10	5.9	5.4	60.3	92	57.3	88	54.4	86.6	51.4	82.6	48	83	45	71	25	36
100	19.1	17.2	45.3	79	42.3	72	26.2	61.8	23.2	54.8	28	61	25	51	20.1	39
200	27.6	24.6	40.8	72	37.8	67	13.2	47.4	10.2	42.4	22	56	19	43	18	37
250	31.1	27.7	39.3	70	36.3	63	8.3	42.3	5.3	35.3	20	52	17	42	17.3	36
300	34.3	30.5	38.1	68	35.1	61	3.9	37.5	0.9	30.5	18.5	49	15.5	41	17.3	35
400	40.1	35.5	35.3	65	33.3	57	-4.8	29.5	-6.8	21.5	15.8	46	12.8	38	17.3	34
500	45.3	40	34.8	61	31.8	55	-10.4	21	-13.4	15	14	42	11	36	17.3	33

Code	Description	Euroclass	Packaging
M05B2833	R6A+ UT4H23 U/UTP CAT6A 4x2xAWG23/1 - unshielded - LSZH	B2ca s1a,d1,a1	500 mt

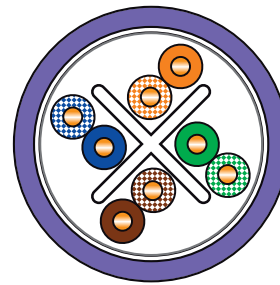
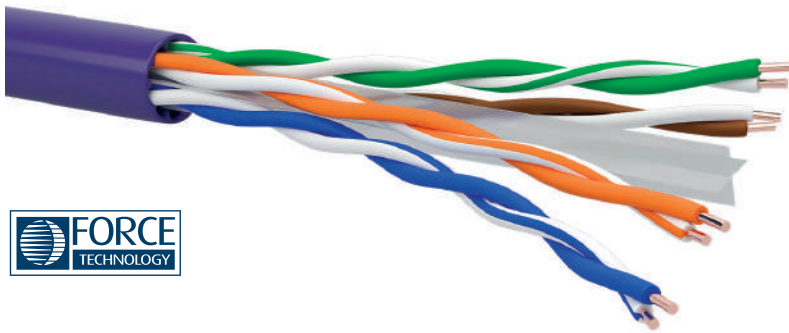

R6A* UT4H23 U/UTP

Suitable for 10 Gigabit Ethernet
Tested up to 500 MHz



U/UTP CAT6_A unshielded 4-pair cable (100 Ohm) with cross separator and non-conductive barrier tape, LSZH (Low Smoke Zero Halogen) flame and fire retardant jacket, tested up to 500 MHz. Suitable for the realization of 3rd generation horizontal cabling of Class E_A.

Applications and performance

Cable suitable for the realization of generic cabling system according to EN 50173; ISO/IEC 11801. Ideal for indoor applications in Class D, E and E_A up to 10 GbE over IEEE 802.3an and PoE/PoE+/PoE++ protocols. Electrical characteristics exceed CAT. 6_A requirements.

Reference standards

Force Technology approval for data transmission cables of Category 6_A according to ISO/IEC 11801-1/2:2017; IEC 61156-5:2020 Ed.3; EN 50173-1/2:2018; EN 50288-11-1: 2012; ANSI/TIA-568-2.D, Alien crosstalk PS ANEXT and PS AACR-F parameters included.

Construction characteristics

Inner conductors - material/diameter	Solid bare copper/AWG 23/1 (0,55 mm)
Insulation - material/diameter	Solid PE max diam. 1,1 mm
Cable diameter	7,4 ± 0,3 mm
Barrier tape	Non-conductive tape + PET foil
Outer jacket material/colour	LSZH/Violet RAL 4005
Lead free	Yes
Cable weight	55 kg/km

Mechanical and environmental properties

Use	Indoor
Bend.radius during instalation	8 x outer diameter
Bend.radius after installation	4 x outer diameter
Max pull strength	110 N (11kg max.)
Installation temperature	from 0°C to +50°C
Operating temperature	from -10°C to +60°C

Fire behaviour

CPR Regulation	EN 50575
Fire behaviour	EN 50399
	EN 60332-1-2; CEI 20-35/1-2
Acid gas emission	EN 60754-2; CEI 20-37/2-2
Smoke density	EN 61034-2; CEI 20-37/3-1

Electrical characteristics at 20°C

DC loop conductor resistance	18.5 Ohm/100m
Insulation resistance	5 GOhm x km
Mutual capacitance	56 pF/m
Capacitance unbalance	3300 pF/km
NVP nominal velocity of propagation	72%
Max. propagation delay	570 ns/100m
Characteristic impedance	100 ± 15 Ohm

*according to EN 50288-11-1 (2012), IEC 61156-5(2012)

ELECTRIC CHARACTERISTICS ACCORDING TO FREQUENCY

Freq MHz	Attenuation		NEXT		PS-NEXT		ACR		PS-ACR		ACR-F		PS-ACR-F		RL	
	max.*	Typ.	min.*	Typ.	min.*	Typ.	min.*	Typ.	min.*	Typ.	min.*	Typ.	min.*	Typ.	min.*	Typ.
1	2.1	1.8	75.3	100	72.3	98	73.2	98.2	70.2	96.2	68	101	65	88	-	31
10	5.9	5.4	60.3	92	57.3	88	54.4	86.6	51.4	82.6	48	83	45	71	25	36
100	19.1	17.2	45.3	79	42.3	72	26.2	61.8	23.2	54.8	28	61	25	51	20.1	39
200	27.6	24.6	40.8	72	37.8	67	13.2	47.4	10.2	42.4	22	56	19	43	18	37
250	31.1	27.7	39.3	70	36.3	63	8.3	42.3	5.3	35.3	20	52	17	42	17.3	36
300	34.3	30.5	38.1	68	35.1	61	3.9	37.5	0.9	30.5	18.5	49	15.5	41	17.3	35
400	40.1	35.5	35.3	65	33.3	57	-4.8	29.5	-6.8	21.5	15.8	46	12.8	38	17.3	34
500	45.3	40	34.8	61	31.8	55	-10.4	21	-13.4	15	14	42	11	36	17.3	33

Code	Description	Euroclass	Packaging
M05B2834	R6A+ UT4H23 U/UTP CAT6A 4x2xAWG23/1 - unshielded - LSZH	B2ca s1a,d1,a1	500 mt

Cables

Category 6_A

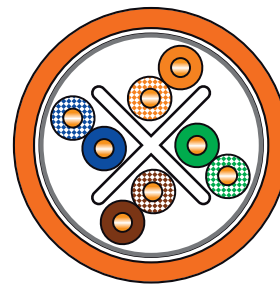
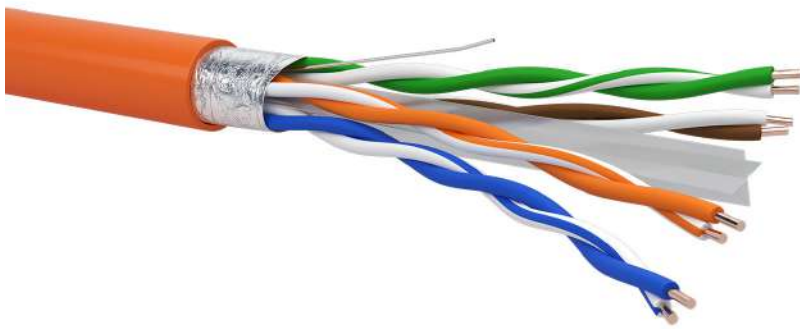

R6A-FT4H23 F/UTP

Suitable for 10 Gigabit Ethernet
Tested up to 500 MHz



F/UTP Category 6A 4-pair cable (100 Ohm) with cross separator, shielded with an Aluminium/Polyester tape, LSZH (Low Smoke Zero Halogen) flame retardant jacket, tested up to 500 MHz. Suitable for the realization of transmission channels of Class Ea.

Applications and performance

Cable suitable for the realization of generic cabling systems according to EN 50173; ISO/IEC 11801.

Ideal for indoor applications in Class D, E and Ea up to 10 GbE over IEEE 802.3an and PoE/PoE+/PoE++ protocols. Electrical characteristics exceed Category 6A requirements.

Certifications and approvals

Data transmission cables of Category 6A according to ISO/IEC 11801; IEC 61156-5; EN 50173-1; ANSI/TIA-568.2-D.

Construction characteristics

Inner conductors - material/diameter	Solid bare copper/AWG 23/1 (0,56mm)
Insulation - material/diameter	Solid PE max. diam. 1,14 mm
Overall shield	Al/PET tape + CuSn drain wire
Cable diameter	7,4 ± 0,3 mm
Outer jacket material/colour	LSZH/Orange RAL 2003
Lead-free	Yes
Cable weight	60 kg/Km

Mechanical and environmental properties

Use	Indoor
Bend radius during installation	8 x outer diameter
Bend radius after installation	4 x outer diameter
Max pull strenght	110 N (11kg max.)
Installation temperature	From 0°C to +50°C
Operating temperature	From -10°C to +60°C

Fire behaviour

CPR Regulation	EN 50575
Fire behaviour	EN 60332-1-2; CEI 20-35/1-2
Acid gas emission	EN 60754-2; CEI 20-37/2-2
Smoke density	EN 61034-2; CEI 20-37/3-1

Electrical properties at 20°C

DC loop cond.resistance	19 Ohm/100m
Insulation resistance	5 GOhm x km
Mutual capacitance	56 pF/m
Capacitance unbalance	3300 pF/km
NPV nominal velocity of propagation	65%
Max. propagation delay	480 ns/100m
Characteristic impedance	100 ± 15 Ohm

*according to EN 50288-10-1 (2012), IEC 61156-5(2012)

ELECTRIC CHARACTERISTICS ACCORDING TO FREQUENCY

Freq MHz	Attenuation dB@100m		NEXT dB		PS-NEXT dB		ACR dB@100m		PS-ACR dB@100m		ACR-F dB@100m		PS-ACR-F dB@100m		RL dB	
	max.*	Typ.	min.*	Typ.	min.*	Typ.	min.*	Typ.	min.*	Typ.	min.*	Typ.	min.*	Typ.	min.*	Typ.
1	2.1	1.9	75.3	92	72.3	90	73.2	90.1	70.2	88.1	68	110	65	102	-	27
10	5.9	5.3	60.3	81	57.3	78	54.4	75.7	51.4	72.7	48	91	45	82	25	38
100	19.1	16.8	45.3	64	42.3	60	26.2	47.2	23.2	43.2	28	62	25	59	20.1	37
200	27.6	24	40.8	61	37.8	55	13.2	37	10.2	31	22	59	19	52	18	36
250	31.1	27	39.9	60	36.3	54	8.3	33	5.3	27	20	58	17	48	17.3	36
300	34.3	29.8	38.1	58	35.1	53	3.9	28.2	0.9	23.2	18.5	55	15.5	46	16.8	35
450	40.1	35	35.3	56	33.3	50	- 4.8	21	- 6.8	15	15.8	51	12.8	44	15.9	32
500	45.3	39.3	33.8	53	31.8	47	-10.4	13.7	-13.4	7.7	14	48	11	41	15.2	30

Code	Description	Euroclass	Packaging
M0502832	R6A-FT4H23 F/UTP CAT6A 4x2xAWG23/1 - shielded - LSZH	Eca	500 mt

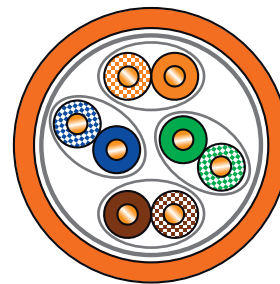
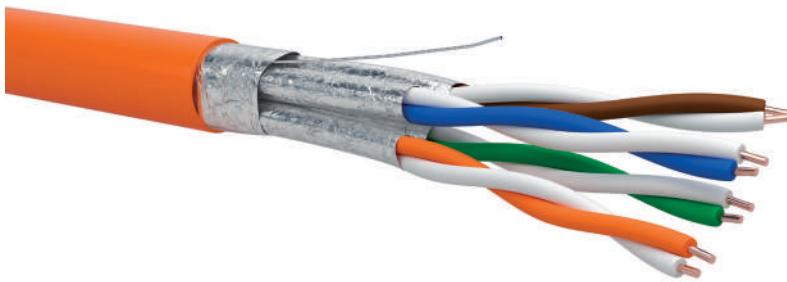

R6A-FF4H23 F/FTP

Suitable for 10 Gigabit Ethernet
tested up to 500 MHz



F/FTP CAT6A, 4-pair cable (100 Ohm), shielding with AL/PET tape on the overall and the single pairs, LSZH (Low Smoke Zero Halogen) flame retardant jacket, tested up to 500 MHz. Suitable for the realization of transmission channels of Class E_A.

Applications and performance

Cable suitable for the realization of generic cabling systems according to EN 50173; ISO/IEC 11801.

Ideal for indoor applications in Class EA up to 10 GbE over IEEE 802.3an protocol and PoE/PoE+/PoE++. Electrical characteristics exceed Category 6A requirements.

Certifications and approvals

Data transmission cables of Category 6A according to ISO/IEC 11801, IEC 61156-5, EN50173-1, ANSI/TIA-568.2-D

Construction characteristics

Inner conductors - material/diameter	Solid bare copper/AWG 23/1
Insulation - material/diameter	Foam skin PE max. diam. 1,35 mm
Pair Shield	Al/PET tape
Overall shield	Al/PET tape
Cable diameter	7,7 ± 0,3 mm
Outer jacket - material/color	LSZH/Orange RAL 2003
Lead-free	Yes
Cable weight	55 kg/Km

Mechanical and environmental properties

Use	Indoor
Bend. radius during installation	60 mm (8 x outer diameter)
Bend. radius after installation	30 mm (4 x outer diameter)
Max pull strength	110 N (11kg max.)
Installation temperature	From 0°C to +50°C
Operating temperature	From -20°C to +60°C

Fire behavior

CPR Regulation	EN 50575
Fire behaviour	EN 50399 EN 60332-1-2; CEI 20-35/1-2
Acid gas emission	EN 60754-2; CEI 20-37/2-2
Smoke density	EN 61034-2; CEI 20-37/3-1

Electrical properties at 20°C

DC loop cond. resistance	15 Ohm/100m
Insulation resistance	5 GOhm x km
Mutual capacitance	45 pF/m
NVP nominal velocity of propagation	78%
Max. propagation delay	425 ns/100m
Characteristic impedance	100 ± 5 Ohm

*according to EN 50288-10-1; IEC 61156-5(2012)

ELECTRICAL CHARACTERISTICS ACCORDING TO FREQUENCY

Freq MHz	Attenuation		NEXT		PS-NEXT		ACR		PS-ACR		ACR-F		PS-ACR-F		RL	
	max.*	Typ.	min.*	Typ.	min.*	Typ.	min.*	Typ.	min.*	Typ.	min.*	Typ.	min.*	Typ.	min.*	Typ.
1	2.1	1.9	75.3	100	72.3	90	73.2	98	73.2	98	68	103	65	100	-	24
10	5.9	5.6	60.3	100	57.3	90	54.4	94	54.4	94	48	98	45	95	25	30
100	19.1	17.8	45.3	98	42.3	87	26.2	80	26.2	80	28	80	25	77	20.1	30
200	27.6	25.1	40.8	93	37.8	83	13.2	68	13.2	68	22	72	19	69	18	28
300	34.3	31.0	38.1	88	35.1	77	3.9	57	3.9	57	18.5	70	15.5	66	17.3	26
450	42.7	38.3	35.5	85	32.5	73	-7.2	47	-10.2	34.7	14.9	64	11.9	53	17.3	25
500	45.3	41.8	34.8	83	31.8	72	-10.4	41	-13.4	30	14	62	11	60	17.3	23

Code	Description	Euroclass	Packaging
M05D2825	R6A-FF4H23 F/FTP CAT6A 4x2xAWG23/1 - shielded - LSZH	Dca s2,d2,a1	500 mt

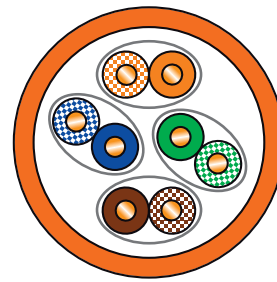
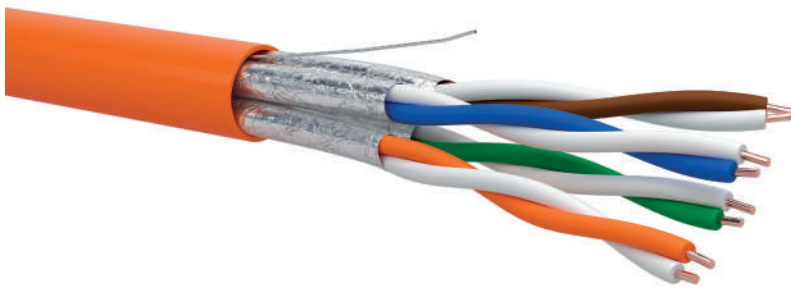

R6A-UF4H23 U/FTP

Suitable for 10 Gigabit Ethernet
tested up to 500 MHz



U/FTP CAT6A, 4-pair cable (100 Ohm), shielded with AL/PET tape applied to each twisted pair, FR LSZH (Low Smoke Zero Halogen) flame retardant jacket, tested up to 500 MHz. Suitable for the realization of transmission channels of Class EA.

Applications and performance

Cable suitable for the realization of generic cabling systems according to EN 50173; ISO/IEC 11801.

Ideal for indoor applications in Class EA up to 10 GbE over IEEE 802.3an protocol and PoE/PoE+/PoE++. Electrical characteristics exceed Category 6A requirements.

Certifications and approvals

Data transmission cables of Category 6A according to ISO/IEC 11801, IEC 61156-5, EN50173-1, ANSI/TIA-568.2-D

Construction characteristics

Inner conductors - material/diameter	Solid bare copper/AWG 23/1
Insulation - material/diameter	Foam skin PE max. diam. 1,35 mm
Pair Shield	Al/PET tape + CuSn drain wire
Cable diameter	7,4 ± 0,3 mm
Outer jacket - material/color	LSZH/Orange RAL 2003
Lead-free	Yes
Cable weight	51 kg/Km

Mechanical and environmental properties

Use	Indoor
Bend. radius during installation	60 mm (8 x outer diameter)
Bend. radius after installation	30 mm (4 x outer diameter)
Max pull strength	110 N (11kg max.)
Installation temperature	From 0°C to +50°C
Operating temperature	From -20°C to +60°C

Fire behavior

CPR Regulation	EN 50575
Fire behaviour	EN 50399
	EN 60332-1-2; CEI 20-35/1-2
Acid gas emission	EN 60754-2; CEI 20-37/2-2
Smoke density	EN 61034-2; CEI 20-37/3-1

Electrical properties at 20°C

DC loop cond. resistance	15 Ohm/100m
Insulation resistance	5 GOhm x km
Mutual capacitance	45 pF/m
NVP nominal velocity of propagation	78%
Max. propagation delay	425 ns/100m
Characteristic impedance	100 ± 5 Ohm

*according to EN 50288-10-1; IEC 61156-5(2012)

ELECTRICAL CHARACTERISTICS ACCORDING TO FREQUENCY

Freq MHz	Attenuation		NEXT		PS-NEXT		ACR		PS-ACR		ACR-F		PS-ACR-F		RL	
	dB/100m		dB		dB		dB@100m		dB@100m		dB@100m		dB@100m		dB	
	max.*	Typ.	min.*	Typ.	min.*	Typ.	min.*	Typ.	min.*	Typ.	min.*	Typ.	min.*	Typ.	min.*	Typ.
1	2.1	1.9	75.3	100	72.3	102	73.2	98	70.2	100.1	68	103	65	102	-	24
10	5.9	5.4	60.3	100	57.3	90	54.4	94	51.4	84.6	48	98	45	83	25	30
100	19.1	17.8	45.3	98	42.3	85	26.2	80	23.2	67.2	28	80	25	70	20.1	30
200	27.6	25.7	40.8	93	37.8	80	13.2	68	10.2	54.3	22	72	19	63	18	28
300	34.3	31.5	38.1	88	35.1	76	3.9	57	0.9	44.5	18.5	70	15.5	57	17.3	26
450	42.7	38.3	35.5	85	32.5	70	-7.2	47	-10.2	31.7	14.9	64	11.9	53	17.3	25
500	45.3	41.8	34.8	83	31.8	68	-10.4	41	-13.4	27.1	14	62	11	51	17.3	23

Code	Description	Euroclass	Packaging
M05D2826	R6A-UF4H23 U/FTP CAT6A 4x2xAWG23/1 - shielded - LSZH	Dca s2,d2,a1	500 mt

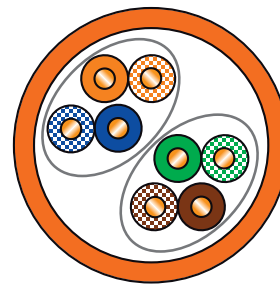
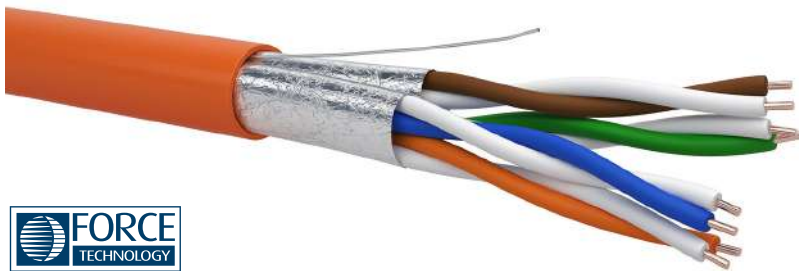

R6A-UF4H23 U/FTP

Suitable for 10 Gigabit Ethernet
Tested up to 500 MHz



U/FTP CAT. 6_A, 4-pair cable (100 Ohm), foil shielded with an Aluminum/polyester tape applied to 2-pair units, FR LSZH (Low Smoke Zero Halogen) flame and fire retardant jacket, tested up to 500 MHz. Suitable for the realization of transmission channels of Class E_A.

Applications and performance

Cable suitable for the realization of generic cabling systems according to EN 50173; ISO/IEC 11801.

Ideal for indoor applications in Class D, E and E_A up to 1GbE over IEEE 802.3an and PoE/PoE+/PoE++ protocols. Electrical characteristics exceed Category 6_A requirements.

Reference standards

Force Technology approval for data transmission cables of Category 6_A according to ISO/IEC 11801-1/2:2017; IEC 61156-5:2012 (Ed.2.1); EN50173-1/2:2018; EN50288-10-1:2012; ANSI/TIA-568.2-D.

Construction characteristics

Inner conductors - material/diameter	Solid bare copper/AWG 23/1(0,56 mm)
Insulation - material/diameter	Foam skin PE max diam. 1,30 mm
Shields on 2-pair units	Al/PET tape
Cable diameter	6,8 ± 0,3 mm
Drain wire	CuSn
Outer jacket - material/color	LSZH/Orange RAL 2003
Lead-free	Yes
Cable weight	60 kg/Km

Mechanical and environmental properties

Use	Indoor
Bend. radius during installation	8 x outer diameter
Bend. radius after installation	4 x outer diameter
Max pull strength	110 N (11kg max.)
Installation temperature	From 0°C to +60°C
Operating temperature	From -10°C to +60°C

Fire behaviour

CPR Regulation	EN 50575
Fire behaviour	EN 50399
	EN 60332-1-2; CEI 20-35/1-2
Acid gas emission	EN 60754-2; CEI 20-37/2-2
Smoke density	EN 61034-2; CEI 20-37/3-1

Electrical properties at 20°C

DC loop cond. resistance	19 Ohm/100m
Insulation resistance	5 GOhm x km
Capacitance unbalance	1600 pF/km
NVP nominal velocity of propagation	78%
Max. propagation delay	534 ns/100m
Characteristic impedance	100 ± 15 Ohm

*according to EN 50288-10-1 (2012), IEC 61156-5(2012)

ELECTRICAL CHARACTERISTICS ACCORDING TO FREQUENCY

Freq MHz	Attenuation dB@100m		NEXT dB		PS-NEXT dB		ACR dB@100m		PS-ACR dB@100m		ACR-F dB@100m		PS-ACR-F dB@100m		RL dB	
	max.*	Typ.	min.*	Typ.	min.*	Typ.	min.*	Typ.	min.*	Typ.	min.*	Typ.	min.*	Typ.	min.*	Typ.
1	2.1	1.9	75.3	105	72.3	102	73.2	103.1	70.2	100.1	68	110	65	102	-	27
10	5.9	5.4	60.3	95	57.3	90	54.4	89.6	51.4	84.6	48	96	45	83	25	41
100	19.1	17.8	45.3	91	42.3	85	26.2	73.2	23.2	67.2	28	81	25	70	20.1	36
200	27.6	25.7	40.8	88	37.8	80	13.2	62.3	10.2	54.3	22	73	19	63	18	35
250	31.1	28.6	39.9	87	36.3	77	8.3	58.4	5.3	48.4	20	71	17	59	17.3	34
300	34.3	31.5	38.1	85	35.1	76	3.9	53.5	0.9	44.5	18.5	68	15.5	57	16.8	33
400	40.1	37.5	35.3	81	33.3	72	-4.8	43.5	-6.8	32.7	15.8	65	12.8	54	15.9	32
500	45.3	40.9	34.8	77	31.8	68	-10.4	36.1	-13.4	27.1	14	62	11	51	15.2	29

Code	Description	Euroclass	Packaging
M05C2823	R6A-UF4H23 U/FTP CAT6A 4x2xAWG23/1 - shielded - LSZH	Cca s1a, d1, a1	500 mt

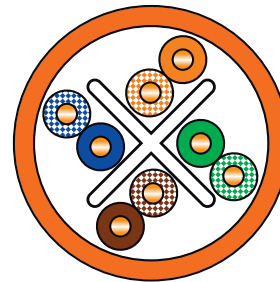
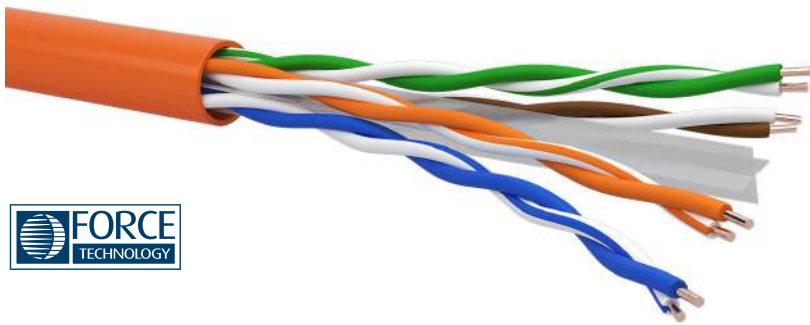

R6UT4Y23 - R6UT4H23 U/UTP

U/UTP CAT6, unshielded 4-pair cable (100 Ohm) with cross separator, PVC or LSZH (Low Smoke Zero Halogen) flame retardant jacket, tested up to 500 MHz. Suitable for the realization of transmission channels of Class E.

Applications and performance

Cable suitable for the realization of generic cabling systems according to EN 50173; ISO/IEC 11801.

Ideal for indoor applications in Class E up to 1GbE over IEEE 802.3ab and PoE/PoE+/PoE++ protocols. Electrical characteristics exceed Category 6 requirements.

Certifications and approvals

Force Technology approval for data transmission cables of Category 6 according to ISO/IEC 11801 Ed. 1/2:2017; IEC 61156-5:2012 (Ed.2.1); EN 50173-1/2:2018; EN 50288-6-1:2013; ANSI/TIA-568.2-D.

Construction characteristics

Inner conductors - material/diameter	Solid bare copper/AWG 23/1(0,57 mm)
Insulation - material/diameter	Solid PE max. diam. 1,0 mm
Cable diameter	From 6 to 6,5 ± 0,3 mm
Outer jacket - material/color	PVC/White RAL 9018 LSZH/Orange RAL 2003
Lead-free	Yes
Cable weight	From 39 to 53 kg/Km

Suitable for Gigabit Ethernet
Tested up to 500 MHz



Mechanical and environmental properties

Use	Indoor
Bend. radius during installation	8 x outer diameter
Bend. radius after installation	4 x outer diameter
Max pull strength	110 N (11kg max.)
Installation temperature	From 0°C to +60°C
Operating temperature	From -10°C to +60°C

Fire behaviour

CPR Regulation	EN 50575
Fire behaviour	EN 50399 (only for Euroclasses B2ca and Dca) EN 60332-1-2; CEI 20-35/1-2
Acid gas emission	EN 60754-2; CEI 20-37/2-2
Smoke density	EN 61034-2; CEI 20-37/3-1

Electrical properties at 20°C

DC loop cond. resistance	19 Ohm/100m
Insulation resistance	5 GOhm x km
Mutual capacitance	48 pF/m
Capacitance unbalance	1600 pF/km
NVP nominal velocity of propagation	68%
Max. propagation delay	570 ns/100m
Characteristic impedance	100 ± 15 Ohm

*according to EN 50288-6-1 (2013), IEC 61156-5(2012)

ELECTRICAL CHARACTERISTICS ACCORDING TO FREQUENCY

Freq MHz	Attenuation dB/100m		NEXT dB		PS-NEXT dB		ACR dB@100m		PS-ACR dB@100m		ACR-F dB@100m		PS-ACR-F dB@100m		RL dB	
	max.*	Typ.	min.*	Typ.	min.*	Typ.	min.*	Typ.	min.*	Typ.	min.*	Typ.	min.*	Typ.	min.*	Typ.
1	2.1	1.7	66	90	64	87	64	88.3	62	85.3	66	86	64	77	-	26
10	6	5.2	59	80	57	73	53	74.8	51	67.8	50	68	47	61	25	32
31.25	10.7	9.4	52	72	50	66	41	62.6	39	56.6	40	60	37	51	23.6	33
62.5	15.5	13.5	47	67	45	61	32	53.5	30	47.5	34	54	31	46	21.5	31
100	19.9	17.1	44	65	42	57	24	47.9	22	39.9	30	48	27	41	20.1	30
155	25.3	21.6	41	62	39	54	16	40.4	14	32.4	26	45	23	37	18.8	28
200	29.1	24.7	40	60	38	53	11	35.3	9	28.3	24	41	21	35	18	27
250	33	27.6	38	57	36	52	5	29.4	3	24.4	22	36	19	30	17.3	26
300	-	31.2	-	55	-	51	-	23.8	-	19.8	-	35	-	29	-	25
400	-	36	-	53	-	49	-	17	-	13	-	32	-	26	-	23
500	-	40.7	-	51	-	48	-	10.3	-	7.3	-	30	-	24	-	21

Code	Description	Euroclass	Packaging
M0502820	R6UT4Y23 U/UTP CAT6 4x2x23AWG - unshielded - PVC	Eca	305/1000 mt
M0502669	R6UT4H23 U/UTP CAT6 4x2x23AWG - unshielded - LSZH	Eca	305/1000 mt
M05D2669	R6UT4H23 U/UTP CAT6 4x2x23AWG - unshielded - LSZH	Dca s2,d2,a1	500 mt
M05B2669	R6UT4H23 U/UTP CAT6 4x2x23AWG - unshielded - LSZH	B2ca s1a,d1,a1	500 mt

Category 6 SLIM

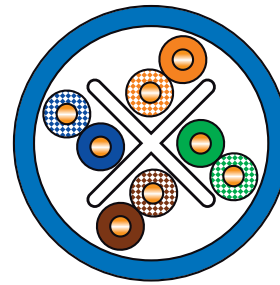
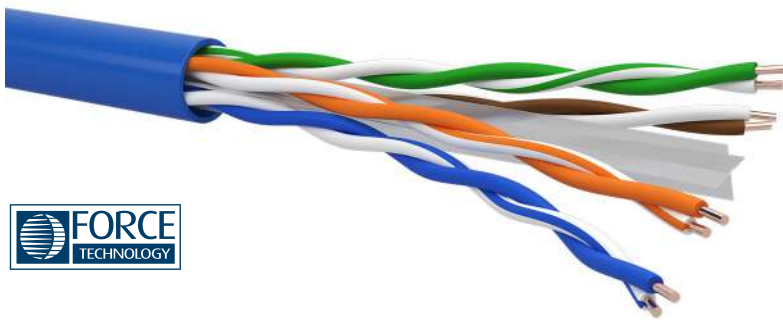

R6UT4H24 U/UTP

U/UTP CAT6, unshielded 4-pair cable (100 Ohm) with cross separator, LSZH (Low Smoke Zero Halogen) flame retardant jacket, tested up to 250 MHz. Suitable for the realization of transmission channels of Class E.

Applications and performance

Cable suitable for the realization of generic cabling systems according to EN 50173; ISO/IEC 11801.

Ideal for indoor applications in Class E up to 1GbE over IEEE 802.3ab protocol and PoE/PoE+/PoE++ applications. Electrical characteristics exceed Category 6 requirements.

Certifications and approvals

Force Technology approval for data transmission cables of Category 6 according to ISO/IEC 11801-1/2:2017; IEC 61156-5:2012 (Ed.2.1); EN 50173-1/2:2018; EN 50288-6-1:2013; ANSI/TIA-568.2-D.

Construction characteristics

Inner conductors - material/diameter	Solid bare copper/AWG 24/1(0,54 mm)
Insulation - material/diameter	Solid PE max. diam. 0,96 mm
Cable diameter	From 5,7 to 6,1 ± 0,3 mm
Outer jacket - material/color	LSZH/Blue RAL 5015
Lead-free	Yes
Cable weight	40 kg/Km

Suitable for Gigabit Ethernet
Tested up to 250 MHz



Mechanical and environmental properties

Use	Indoor
Bend. radius during installation	8 x outer diameter
Bend. radius after installation	4 x outer diameter
Max pull strength	110 N (11 kg max.)
Installation temperature	From 0°C to +50°C
Operating temperature	From -10°C to +60°C

Fire behaviour

CPR Regulation	EN 50575
Fire behaviour	EN 50399 (only for Euroclass Cca and Dca)
	EN 60332-1-2; CEI 20-35/1-2
Acid gas emission	EN 60754-2; CEI 20-37/2-2
Smoke density	EN 61034-2; CEI 20-37/3-1

Electrical properties at 20°C

DC loop cond. resistance	19 Ohm/100m
Insulation resistance	5 GOhm x km
Mutual capacitance	56 pF/m
Capacitance unbalance	3300 pF/km
NVP nominal velocity of propagation	68%
Max. propagation delay	570 ns/100m
Characteristic impedance	100 ± 15 Ohm

*according to EN 50288-6-1 (2013), IEC 61156-5(2012)

ELECTRICAL CHARACTERISTICS ACCORDING TO FREQUENCY

Freq MHz	Attenuation dB@100m		NEXT dB		PS-NEXT dB		ACR dB@100m		PS-ACR dB@100m		ACR-F dB@100m		PS-ACR-F dB@100m		RL dB	
	max.*	Typ.	min.*	Typ.	min.*	Typ.	min.*	Typ.	min.*	Typ.	min.*	Typ.	min.*	Typ.	min.*	Typ.
1	2.1	1.8	66	90	64	85	64	88.2	62	83.2	66	80	64	74	-	26
10	6	5.7	59	81	57	74	53	75.3	51	69.6	50	65	47	60	25	32
31.25	10.7	10.4	52	74	50	66	41	63.6	39	55.6	40	56	37	50	23.6	33
62.5	15.5	14.8	47	67	45	60	32	52.2	30	45.2	34	51	31	45	21.5	33
100	19.9	19	44	65	42	58	24	46	22	39	30	46	27	41	20.1	31
155	25.3	23.9	41	61	39	55	16	37.1	14	31.1	26	42	23	37	18.8	30
200	29.1	27	40	60	38	53	11	33	9	26	24	40	21	34	18	29
250	33	30.3	38	56	36	52	5	25.7	3	21.7	22	35	19	30	17.3	27

Code	Description	Euroclass	Packaging
M0502701	R6UT4H24 U/UTP CAT6 4x2xAWG23/1 - unshielded - LSZH - SLIM	Eca	305 mt/1000 mt
M05D2701	R6UT4H24 U/UTP CAT6 4x2xAWG23/1 - unshielded - LSZH - SLIM	Dca s2,d2,a1	305 mt/1000 mt
M05C2701	R6UT4H24 U/UTP CAT6 4x2xAWG23/1 - unshielded - LSZH	Cca S1a,d1,a1	305 mt

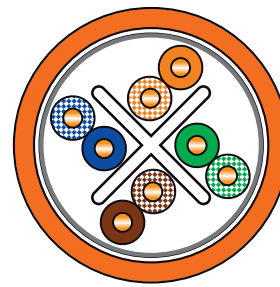
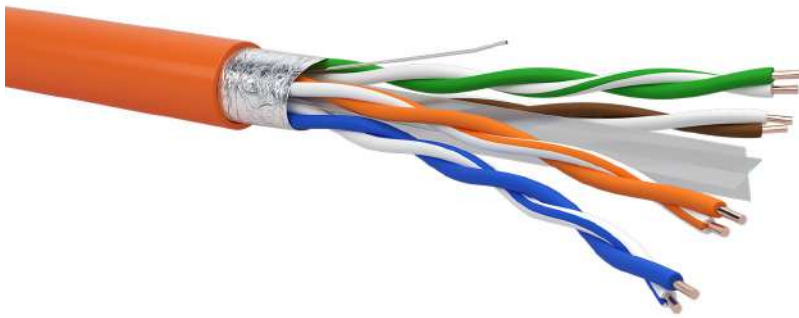

R6FT4H23 F/UTP

F/UTP CAT6, 4-pair cable (100 Ohm) with cross separator, shielded with an Aluminium/polyester tape, LSZH (Low Smoke Zero Halogen) flame retardant jacket, tested up to 500 MHz. Suitable for the realization of transmission channels of Class E.

Applications and performance

Cable suitable for the realization of generic cabling systems according to EN 50173; ISO/IEC 11801.

Ideal for indoor applications in Class E up to 1GbE over IEEE 802.3ab and PoE/PoE+/PoE++ protocols. Electrical characteristics exceed Category 6 requirements.

Reference standards

Data transmission cables of Category 6 according to ISO/IEC 11801; IEC 61156-5; EN 50173-1; ANSI/TIA-568.2-D.

Construction characteristics

Inner conductors - material/diameter	Solid bare copper/AWG 23/1(0,57 mm)
Insulation - material/diameter	Solid PE max. diam. 1,14 mm
Cable diameter	7,1 ± 0,3 mm
Overall shield	Al/PET tape + CuSn Drain Wire
Outer jacket - material/color	LSZH/Orange RAL 2003
Lead-free	Yes
Cable weight	53 kg/Km

Suitable for Gigabit Ethernet
Tested up to 500 MHz



Mechanical and environmental properties

Use	Indoor
Bend. radius during installation	8 x outer diameter
Bend. radius after installation	4 x outer diameter
Max pull strength	110 N (11kg max.)
Installation temperature	From 0°C to +50°C
Operating temperature	From -10°C to +60°C

Fire behaviour

CPR Regulation	EN 50575
Fire behaviour	EN 60332-1-2; CEI 20-35/1-2
Acid gas emission	EN 60754-2; CEI 20-37/2-2
Smoke density	EN 61034-2; CEI 20-37/3-1

Electrical properties at 20°C

DC loop cond. resistance	19 Ohm/100m
Insulation resistance	5 GOhm x km
Mutual capacitance	56 pF/m
Capacitance unbalance	1600 pF/km
NVP nominal velocity of propagation	68%
Max. propagation delay	480 ns/100m
Characteristic impedance	100 ± 15 Ohm

*according to EN 50288-5-1 (2013), IEC 61156-5(2012)

ELECTRICAL CHARACTERISTICS ACCORDING TO FREQUENCY

Freq MHz	Attenuation dB/100m		NEXT dB		PS-NEXT dB		ACR dB@100m		PS-ACR dB@100m		ACR-F dB@100m		PS-ACR-F dB@100m		RL dB	
	max.*	Typ.	min.*	Typ.	min.*	Typ.	min.*	Typ.	min.*	Typ.	min.*	Typ.	min.*	Typ.	min.*	Typ.
1	2.1	1.7	66	90	64	87	64	88.3	62	85.3	66	86	64	77	-	26
10	6	5.2	59	80	57	73	53	74.8	51	67.8	50	68	47	61	25	32
31.25	10.7	9.4	52	72	50	66	41	62.6	39	56.6	40	60	37	51	23.6	33
62.5	15.5	13.5	47	67	45	61	32	53.5	30	47.5	34	54	31	46	21.5	31
100	19.9	17.1	44	65	42	57	24	47.9	22	39.9	30	48	27	41	20.1	30
155	25.3	21.6	41	62	39	54	16	40.4	14	32.4	26	45	23	37	18.8	28
200	29.1	24.7	40	60	38	53	11	35.3	9	28.3	24	41	21	35	18	27
250	33	27.6	38	57	36	52	5	29.4	3	24.4	22	36	19	30	17.3	26
300	-	31.2	-	55	-	51	-	23.8	-	19.8	-	35	-	29	-	25
400	-	36	-	53	-	49	-	17	-	13	-	32	-	26	-	23
500	-	40.7	-	51	-	48	-	10.3	-	7.3	-	30	-	24	-	21

Code	Description	Euroclass	Packaging
M0502668	R6FT4H23 F/UTP CAT6 4x2xAWG23/1 - shielded - LSZH	Eca	1000 mt

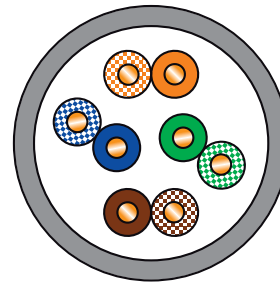
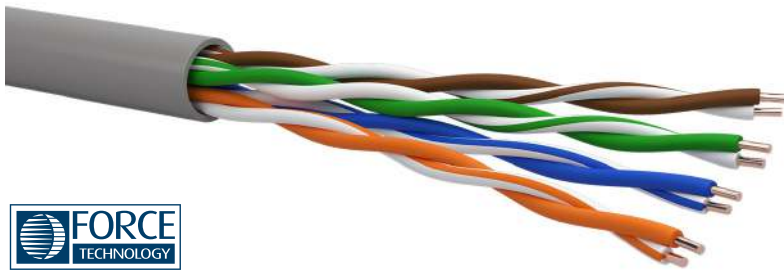

CPR 6707 U/UTP

Suitable for Gigabit Ethernet
Tested up to 200 MHz



U/UTP CAT5E, unshielded 4-pair cable (100 Ohm), with PVC or LSZH (Low Smoke Zero Halogen) outer jacket, flame retardant, tested up to 200 MHz. Suitable for the realization of transmission channels of Class D.

Applications and performance

Cable suitable for the realization of generic cabling systems according to EN 50173; ISO/IEC 11801.

Ideal for indoor applications in Class D up to 1GbE on IEEE 802.3ab and Poe/PoE+/PoE++ protocols. Electrical characteristics exceed Category 5 Enhanced requirements.

Certifications and approvals

Force Technology approval for data transmission cables of Category 5E according to ISO/IEC 11801-1/2:2017; IEC 61156-5:2012; EN 50173-1/2:2018; EN 50288-3-1:2013; ANSI/TIA-568.2-D.

Construction characteristics

Inner conductors - material/diameter	Solid bare copper/AWG 24/1 (0,51 mm)
Insulation - material/diameter	Solid PE, max. diam. 1,07 mm
Cable diameter	5 ± 0,3 mm
Outer jacket - material/color	PVC or LSZH/Grey RAL 7032
Lead free	Yes
Cable Weight	35 Kg/Km

Mechanical and environmental properties

Use	Indoor
Bend. radius during installation	8 x outer diameter
Bend. radius after installation	4 x outer diameter
Max pull strength	110 N (11kg max.)
Installation temperature	From 0°C to +50°C
Operating temperature	From -10°C to +60°C

Fire behaviour

CPR Regulation	EN 50575
Fire behaviour	EN 60332-1-2; CEI 20-35/1-2
Acid gas emission (for LSZH only)	EN 60754-2; CEI 20-37/2-2
Smoke density (for LSZH only)	EN 61034-2; CEI 20-37/3-1

Electrical properties at 20°C

DC loop cond. resistance	16,8 Ohm/100m
Insulation resistance	5 GOhm x km
Mutual capacitance	49 pF/m
Capacitance unbalance	1000 pF/km
NVP nominal velocity of propagation	68%
Max. propagation delay	480 ns/100m
Characteristic impedance	100 ± 15 Ohm

*according to EN 50288-3-1(2013)/IEC 61156-5(2012)

ELECTRICAL CHARACTERISTICS ACCORDING TO FREQUENCY

Freq MHz	Attenuation		NEXT		PS-NEXT		ACR		PS-ACR		ACR-F		PS-ACR-F		RL	
	max.*	Typ.	min.*	Typ.	min.*	Typ.	min.*	Typ.	min.*	Typ.	min.*	Typ.	min.*	Typ.	min.*	Typ.
1	2.1	1.9	65	82	62	76	63	80.1	60	74.1	64	73	61	70	23	27
4	4.0	3.7	56	75	53	67	52	71.3	49	63.3	52	66	49	62	23	32
10	6.3	5.9	50	70	47	62	44	64.1	41	56.1	44	58	41	55	25	39
16	8.0	7.6	47	66	44	59	39	58.4	36	51.4	40	54	37	48	25	40
31.25	11.4	10.7	43	62	40	55	31	51.3	28	44.3	34	50	31	42	23.6	37
62.5	16.5	15.3	38	56	35	50	22	40.7	19	34.7	28	44	25	36	21.5	35
100	21.3	19.5	35	53	32	47	14	33.5	11	27.5	24	35	21	31	20.1	30
155	-	26.3	-	48	-	42	-	21.7	-	15.7	-	32	-	27	-	28
200	-	29.5	-	44	-	40	-	14.5	-	10.5	-	29	-	24	-	27

Code	Description	Euroclass	Packaging
M0502057	CPR 6707 U/UTP CAT5E 4x2xAWG24/1 - unshielded - PVC	Eca	100/305/1000 mt
M0502091	CPR 6707 U/UTP CAT5E 4x2xAWG24/1 - unshielded - LSZH	Eca	305/1000 mt

Cables

Category 5E

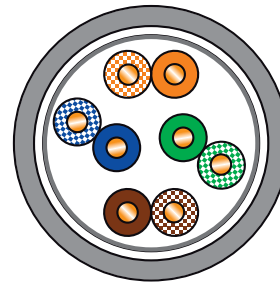
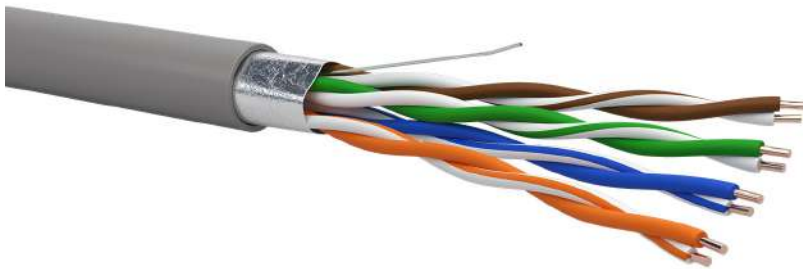

CPR 6727 F/UTP

Suitable for Gigabit Ethernet
Tested up to 200 MHz



F/UTP CAT5E, 4-pair cable (100 Ohm), shielded with an Aluminium polyester tape, PVC or LSZH (Low Smoke Zero Halogen) outer jacket, flame retardant, tested up to 200 MHz. Suitable for the realization of transmission channels of Class D.

Applications and performance

Cable suitable for the realization of generic cabling systems according to EN 50173; ISO/IEC 11801.

Ideal for indoor applications in Class D up to 1GbE on IEEE 802.3ab and PoE/PoE+/PoE++ protocols. Electrical characteristics exceed Category 5 Enhanced requirements.

Certifications and approvals

Data transmission cables of Category 5E according to ISO/IEC 11801; IEC 61156-5; EN 50173-1; ANSI/TIA-568.2-D.

Construction characteristics

Inner conductors - material/diameter	Solid bare copper/AWG 24/1 (0,51 mm)
Insulation - material/diameter	Solid PE, max. diam. 1,07 mm
Cable diameter	6,1 ± 0,3 mm
Overall shield	Al/PET tape + CuSn drain wire
Outer jacket - material/color	PVC or LSZH/Grey RAL 7032
Lead free	Yes
Cable Weight	42 Kg/Km

Mechanical and environmental properties

Use	Indoor
Bend. radius during installation	8 x outer diameter
Bend. radius after installation	4 x outer diameter
Max pull strength	110 N (11kg max.)
Installation temperature	From 0°C to +50°C
Operating temperature	From -10°C to +60°C

Fire behaviour

CPR Regulation	EN 50575
Fire behaviour	EN 60332-1-2; CEI 20-35/1-2
Acid gas emission (for LSZH only)	EN 60754-2; CEI 20-37/2-2
Smoke density (for LSZH only)	EN 61034-2; CEI 20-37/3-1

Electrical properties at 20°C

DC loop cond. resistance	16,8 Ohm/100m
Insulation resistance	5 GOhm x km
Mutual capacitance	49 pF/m
Capacitance unbalance	1000 pF/km
NVP nominal velocity of propagation	72%
Max. propagation delay	480 ns/100m
Characteristic impedance	100 ± 15 Ohm

*according to EN 50288-2-1(2013)/IEC 61156-5(2012)

ELECTRICAL CHARACTERISTICS ACCORDING TO FREQUENCY

Freq MHz	Attenuation dB@100m		NEXT dB		PS-NEXT dB		ACR dB@100m		PS-ACR dB@100m		ACR-F dB@100m		PS-ACR-F dB@100m		RL dB	
	max.*	Typ.	min.*	Typ.	min.*	Typ.	min.*	Typ.	min.*	Typ.	min.*	Typ.	min.*	Typ.	min.*	Typ.
1	2.1	1.8	65	86	62	83	63	84.2	60	81.2	64	95	61	90	-	27
4	4.0	3.5	56	77	53	72	52	73.5	49	68.5	52	85	49	77	23	31
10	6.3	5.6	50	72	47	66	44	66.4	41	60.4	44	76	41	66	25	38
16	8.0	7.1	47	68	44	61	39	60.9	36	53.9	40	69	37	62	25	39
31.25	11.4	9.8	43	64	40	58	31	54.2	28	48.2	34	61	31	54	23.6	35
62.5	16.5	14	38	58	35	53	22	44	19	39	28	55	25	50	21.5	31
100	21.3	17.9	35	55	32	50	14	37.1	11	32.1	24	51	21	46	20.1	28
155	-	22.6	-	52	-	46	-	29.4	-	23.4	-	47	-	42	-	25
200	-	25.6	-	49	-	44	-	23.4	-	18.4	-	44	-	39	-	23

Code	Description	Euroclass	Packaging
M0502077	CPR 6727 F/UTP CAT5E 4x2xAWG24/1 - shielded - PVC	Eca	100/305/1000 mt
M0502098	CPR 6727 F/UTP CAT5E 4x2xAWG24/1 - shielded - LSZH	Eca	305/1000 mt

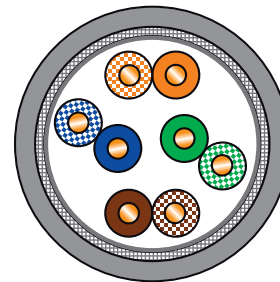
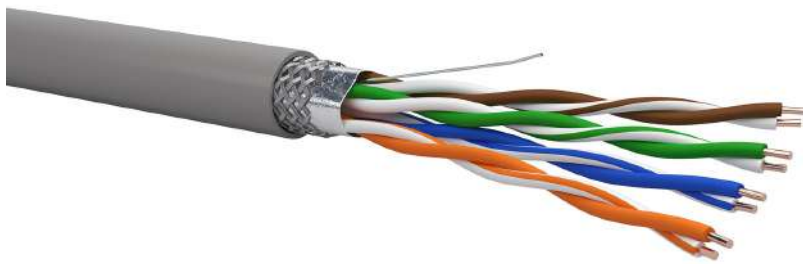

CPR 6727-C SF/UTP

Suitable for Gigabit Ethernet
Tested up to 200 MHz



SF/UTP CAT5E, 4-pair cable (100 Ohm), shielded with an Aluminium polyester tape and tinned copper braid, LSZH (Low Smoke Zero Halogen) outer jacket, flame retardant, tested up to 200 MHz. Suitable for the realization of transmission channels of Class D.

Applications and performance

Cable suitable for the realization of generic cabling systems according to EN 50173; ISO/IEC 11801.

Ideal for indoor applications in Class D up to 1GbE on IEEE 802.3ab and PoE/PoE+/PoE++ protocols. Electrical characteristics exceed Category 5Enhanced requirements.

Reference standards

Data transmission cables of Category 5E according to ISO/IEC 11801; IEC 61156-5; EN50173-1; ANSI/TIA-568.2-D.

Construction characteristics

Inner conductors - material/diameter	Solid bare copper/AWG 24/1 (0,51mm)
Insulation - material/diameter	Solid PE max. diam. 1,07 mm
Cable diameter	6,1 ± 0,3 mm
Overall shield	Al/PET tape + CuSn braid + CuSn drain wire
Outer jacket - material/color	LSZH/Grey RAL 7032
Lead-free	Yes
Cable weight	46 kg/Km

Mechanical and environmental properties

Use	Indoor
Bend. radius during installation	8 x outer diameter
Bend. radius after installation	4 x outer diameter
Max pull strength	110 N (11kg max.)
Installation temperature	From 0°C to +50°C
Operating temperature	From -10°C to +60°C

Fire behaviour

CPR Regulation	EN 50575
Fire behaviour	EN 60332-1-2; CEI 20-35/1-2
Acid gas emission (for LSZH only)	EN 60754-2; CEI 20-37/2-2
Smoke density (for LSZH only)	EN 61034-2; CEI 20-37/3-1

Electrical properties at 20°C

DC loop cond. resistance	16,8 Ohm/100m
Insulation resistance	5 GOhm x km
Mutual capacitance	49 pF/m
Capacitance unbalance	1000 pF/km
NVP nominal velocity of propagation	72%
Max. propagation delay	480 ns/100m
Characteristic impedance	100 ± 15 Ohm

*according to EN 50288-2-1(2013)/IEC 61156-5(2012)

ELECTRICAL CHARACTERISTICS ACCORDING TO FREQUENCY

Freq MHz	Attenuation dB@100m		NEXT dB		PS-NEXT dB		ACR dB@100m		PS-ACR dB@100m		ACR-F dB@100m		PS-ACR-F dB@100m		RL dB	
	max.*	Typ.	min.*	Typ.	min.*	Typ.	min.*	Typ.	min.*	Typ.	min.*	Typ.	min.*	Typ.	min.*	Typ.
1	2.1	1.8	65	86	62	83	63	84.2	60	81.2	64	95	61	90	-	27
4	4.0	3.5	56	77	53	72	52	73.5	49	68.5	52	85	49	77	23	31
10	6.3	5.6	50	72	47	66	44	66.4	41	60.4	44	76	41	66	25	38
16	8.0	7.1	47	68	44	61	39	60.9	36	53.9	40	69	37	62	25	39
31.25	11.4	9.8	43	64	40	58	31	54.2	28	48.2	34	61	31	54	23.6	35
62.5	16.5	14	38	58	35	53	22	44	19	39	28	55	25	50	21.5	31
100	21.3	17.9	35	55	32	50	14	37.1	11	32.1	24	51	21	46	20.1	28
155	-	22.6	-	52	-	46	-	29.4	-	23.4	-	47	-	42	-	25
200	-	25.6	-	49	-	44	-	23.4	-	18.4	-	44	-	39	-	23

Code	Description	Euroclass	Packaging
M0502085	CPR 6727-C SF/UTP CAT5E 4x2xAWG24/1 - double shielded - LSZH	Eca	1000 mt

Outdoor cables

Category 6

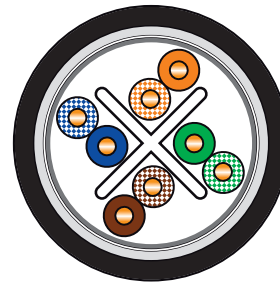
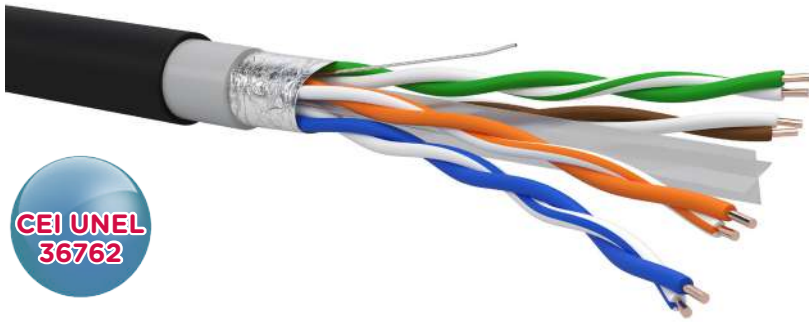

R6FT4YPE23 F/UTP PVC-PE double jacket

Suitable for Gigabit Ethernet
Tested up to 250 MHz



F/UTP CAT6, 4-pair cable (100 Ohm) with cross separator, shielded with an Al/PET tape, double outer jacket: PVC flame retardant inner jacket and PE outer jacket. Tested up to 250MHz. Suitable for the realization of transmission channels of Class E.

Applications and performance

Cable suitable for the realization of generic cabling systems according to EN 50173; ISO/IEC 11801.

Ideal for outdoor applications in Class E up to 1GbE over IEEE 802.3ab and PoE/PoE+/PoE++ protocols. Electrical characteristics exceed Category 6 requirements.

Certifications and approvals

Data transmission cables of Category 6 according to ISO/IEC 11801-1; IEC 61156-5; EN 50173-1; ANSI/TIA-568.2-D. Certified CEI UNEL 36762 on the coexistence in the same conduit with power cables up to 0,6/kV and used for systems with nominal voltage to ground (U₀) up to 400V.

Construction characteristics

Inner conductors - material/diameter	Solid bare copper/AWG 23/1 (0,55mm)
Insulation - material/diameter	Solid PE max. diam. 1,13 mm
Cable diameter	7,9 ± 0,3 mm
Overall shield	Al/PET tape + CuSn drain wire
Inner jacket - material/color	PVC/White RAL 9018
Outer jacket - material/color	PE/Black RAL 9005
Lead-free	Yes
Cable weight	61 kg/Km

Mechanical and environmental properties

Use	Outdoor
Bend. radius during installation	8 x outer diameter
Bend. radius after installation	4 x outer diameter
Max pull strength	110 N (11kg max.)
Installation temperature	From 0°C to +50°C
Operating temperature	From -10°C to +60°C

Fire behaviour

CPR Regulation	EN 50575
Fire behaviour	EN 60332-1-2; CEI 20-35/1-2 (valid only for the inner PVC jacket)

Electrical properties at 20°C

DC loop cond. resistance	19 Ohm/100m
Insulation resistance	5 GOhm x km
Mutual capacitance	50 pF/m
Capacitance unbalance	1600 pF/km
NVP nominal velocity of propagation	68%
Max. propagation delay	570 ns/100m
Characteristic impedance	100 ± 15 Ohm

*according to EN 50288-5-1(2013)/IEC 61156-5(2012)

ELECTRICAL CHARACTERISTICS ACCORDING TO FREQUENCY

Freq MHz	Attenuation dB@100m		NEXT dB		PS-NEXT dB		ACR dB@100m		PS-ACR dB@100m		ACR-F dB@100m		PS-ACR-F dB@100m		RL dB	
	max.*	Typ.	min.*	Typ.	min.*	Typ.	min.*	Typ.	min.*	Typ.	min.*	Typ.	min.*	Typ.	min.*	Typ.
1	2.1	1.7	66	90	64	87	64	88.3	62	85.3	66	86	64	77	-	26
10	6	5.2	59	80	57	73	53	74.8	51	67.8	50	68	47	61	25	32
31.25	10.7	9.4	52	72	50	66	41	62.6	39	56.6	40	60	37	51	23.6	33
62.5	15.5	13.5	47	67	45	61	32	53.5	30	47.5	34	54	31	46	21.5	31
100	19.9	17.1	44	65	42	57	24	47.9	22	39.9	30	48	27	41	20.1	30
155	25.3	21.6	41	62	39	54	16	40.4	14	32.4	26	45	23	37	18.8	28
200	29.1	24.7	40	60	38	53	11	35.3	9	28.3	24	41	21	35	18	27
250	33	27.6	38	57	36	52	5	29.4	3	24.4	22	36	19	30	17.3	26

Code	Description	Euroclass	Packaging
M0502201	R6FT4YPE23 F/UTP 4x2x23/1AWG CAT6 - shielded - PVC/PE	Fca	500 mt

Outdoor cables

Category 6

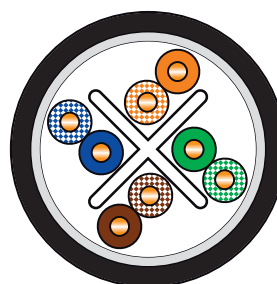
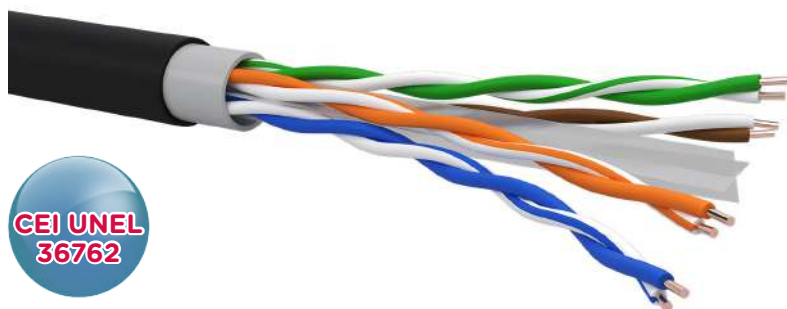

R6UT4YPE23 U/UTP PVC-PE double Jacket

Suitable for Gigabit Ethernet
Tested up to 500 MHz



U/UTP CAT6, unshielded 4-pair cable (100 Ohm) with cross separator and double outer jacket: PVC flame retardant inner jacket and PE outer jacket. Tested up to 500MHz. Suitable for the realization of transmission channels of Class E.

Applications and performance

Cable suitable for the realization of generic cabling systems according to EN 50173; ISO/IEC 11801.

Ideal for outdoor applications in Class E up to 1GbE over IEEE 802.3ab and PoE/PoE+/PoE++ protocols. Electrical characteristics exceed Category 6 requirements.

Certifications and approvals

Data transmission cables of Category 6 according to ISO/IEC 11801; IEC 61156-5; EN 50173-1; ANSI/TIA-568.2-D. Certified CEI UNEL 36762 on the coexistence in the same conduit with power cables up to 0,6/1kV and used for systems with nominal voltage to ground (U₀) up to 400V.

Construction characteristics

Inner conductors - material/diameter	Solid bare copper/AWG 23/1 (0,57mm)
Insulation - material/diameter	Solid PE max. diam. 1,0 mm
Cable diameter	7,1 ± 0,3 mm
Inner jacket - material/color	PVC/White RAL 9018
Outer jacket - material/color	PE/Black RAL 9005
Lead-free	Yes
Cable weight	46 kg/Km

Mechanical and environmental properties

Use	Outdoor
Bend. radius during installation	8 x outer diameter
Bend. radius after installation	4 x outer diameter
Max pull strength	110 N (11kg max.)
Installation temperature	From 0°C to +50°C
Operating temperature	From -10°C to +60°C

Fire behaviour

CPR Regulation	EN 50575
Fire behaviour	EN 60332-1-2; CEI 20-35/1-2 (valid only for the inner PVC jacket)

Electrical properties at 20°C

DC loop cond. resistance	16,4 Ohm/100m
Insulation resistance	5 GOhm x km
Mutual capacitance	48 pF/m
Capacitance unbalance	1000 pF/km
NVP nominal velocity of propagation	68%
Max. propagation delay	485 ns/100m
Characteristic impedance	100 ± 15 Ohm

*according to EN 50288-6-1(2013)/IEC 61156-5(2012)

ELECTRICAL CHARACTERISTICS ACCORDING TO FREQUENCY

Freq MHz	Attenuation dB@100m		NEXT dB		PS-NEXT dB		ACR dB@100m		PS-ACR dB@100m		ACR-F dB@100m		PS-ACR-F dB@100m		RL dB	
	max.*	Typ.	min.*	Typ.	min.*	Typ.	min.*	Typ.	min.*	Typ.	min.*	Typ.	min.*	Typ.	min.*	Typ.
1	2.1	1.7	66	90	64	87	64	88.3	62	85.3	66	86	64	77	-	26
10	6	5.2	59	80	57	73	53	74.8	51	67.8	50	68	47	61	25	32
31.25	10.7	9.4	52	72	50	66	41	62.6	39	56.6	40	60	37	51	23.6	33
62.5	15.5	13.5	47	67	45	61	32	53.5	30	47.5	34	54	31	46	21.5	31
100	19.9	17.1	44	65	42	57	24	47.9	22	39.9	30	48	27	41	20.1	30
155	25.3	21.6	41	62	39	54	16	40.4	14	32.4	26	45	23	37	18.8	28
200	29.1	24.7	40	60	38	53	11	35.3	9	28.3	24	41	21	35	18	27
250	33	27.6	38	57	36	52	5	29.4	3	24.4	22	36	19	30	17.3	26
300	-	31.2	-	55	-	51	-	23.8	-	19.8	-	35	-	29	-	25
400	-	36	-	53	-	49	-	17	-	13	-	32	-	26	-	23
500	-	40.7	-	51	-	48	-	10.3	-	7.3	-	30	-	24	-	21

Code	Description	Euroclass	Packaging
M0502200	R6UT4YPE23 U/UTP 4x2x23/1AWG CAT6 - unshielded - PVC/PE	Fca	500 mt

Outdoor cables

Category 5E Outdoor

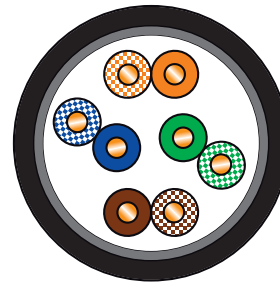

CPR 6709 U/UTP PVC-PE double Jacket

Suitable for Gigabit Ethernet
Tested up to 200 MHz



U/UTP CAT5E, unshielded 4-pair cable (100 Ohm), tested up to 200 MHz and double outer jacket: PVC flame retardant inner jacket and PE outer jacket. Suitable for the realization of transmission channels of Class D.

Applications and performance

Cable suitable for the realization of generic cabling systems according to EN 50173; ISO/IEC 11801.

Ideal for outdoor applications in Class D up to 1GbE over IEEE 802.3ab and PoE/PoE+/PoE++ protocols. Electrical characteristics exceed Category 5E requirements.

Certifications and approvals

CAT5E data transmission cable according to ISO/IEC 11801; IEC 61156-5; EN50173-1; ANSI/TIA-568.2-D. Certified CEI UNEL 36762 on the coexistence in the same conduit with power cables up to 0,6/1kV and used for systems with nominal voltage to ground (U_0) up to 400V.

Construction characteristics

Inner conductors - material/diameter	Solid bare copper/AWG 24/1 (0,51mm)
Insulation - material/diameter	Solid PE max. diam. 1,07 mm
Cable diameter	5,7 ± 0,3 mm
Inner jacket - material/color	PVC/Grey RAL 7032
Outer jacket - material/color	PE/Black RAL 9005
Lead-free	Yes
Cable weight	40 kg/Km

Mechanical and environmental properties

Use	Outdoor
Bend. radius during installation	8 x outer diameter
Bend. radius after installation	4 x outer diameter
Max pull strength	110 N (11kg max.)
Installation temperature	From 0°C to +50°C
Operating temperature	From -10°C to +60°C

Fire behaviour

CPR Regulation	EN 50575
Fire behaviour	EN 60332-1-2; CEI 20-35/1-2 (valid only for the inner PVC jacket)

Electrical properties at 20°C

DC loop cond. resistance	19,0 Ohm/100m
Insulation resistance	5 GOhm x km
Mutual capacitance	49 pF/m
Capacitance unbalance	1000 pF/km
NVP nominal velocity of propagation	68%
Max. propagation delay	480 ns/100m
Characteristic impedance	100 ± 15 Ohm

*according to EN 50288-3-1(2013)/IEC 61156-5(2012)

ELECTRICAL CHARACTERISTICS ACCORDING TO FREQUENCY

Freq MHz	Attenuation		NEXT		PS-NEXT		ACR		PS-ACR		ACR-F		PS-ACR-F		RL	
	max.*	Typ.	min.*	Typ.	min.*	Typ.	min.*	Typ.	min.*	Typ.	min.*	Typ.	min.*	Typ.	min.*	Typ.
1	2.1	1.9	65	82	62	76	63	80.1	60	74.1	64	73	61	70	27	27
4	4.0	3.7	56	75	53	67	52	71.3	49	63.3	52	66	49	62	23	32
10	6.3	5.9	50	70	47	62	44	64.1	41	56.1	44	58	41	55	25	39
16	8.0	7.6	47	66	44	59	39	58.4	36	51.4	40	54	37	48	25	40
31.25	11.4	10.7	43	62	40	55	31	51.3	28	44.3	34	50	31	42	23.6	37
62.5	16.5	15.3	38	56	35	50	22	40.7	19	34.7	28	44	25	36	21.5	35
100	21.3	19.5	35	53	32	47	14	33.5	11	27.5	24	35	21	31	20.1	30
155	-	26.3	-	48	-	42	-	21.7	-	15.7	-	32	-	27	-	28
200	-	29.5	-	44	-	40	-	14.5	-	10.5	-	29	-	24	-	27

Code	Description	Euroclass	Packaging
M0502100	CPR 6709 U/UTP CAT5E 4x2xAWG24/1 - unshielded - PVC/PE	Fca	500 mt

Copper cabling system – Easy Crimp Compact

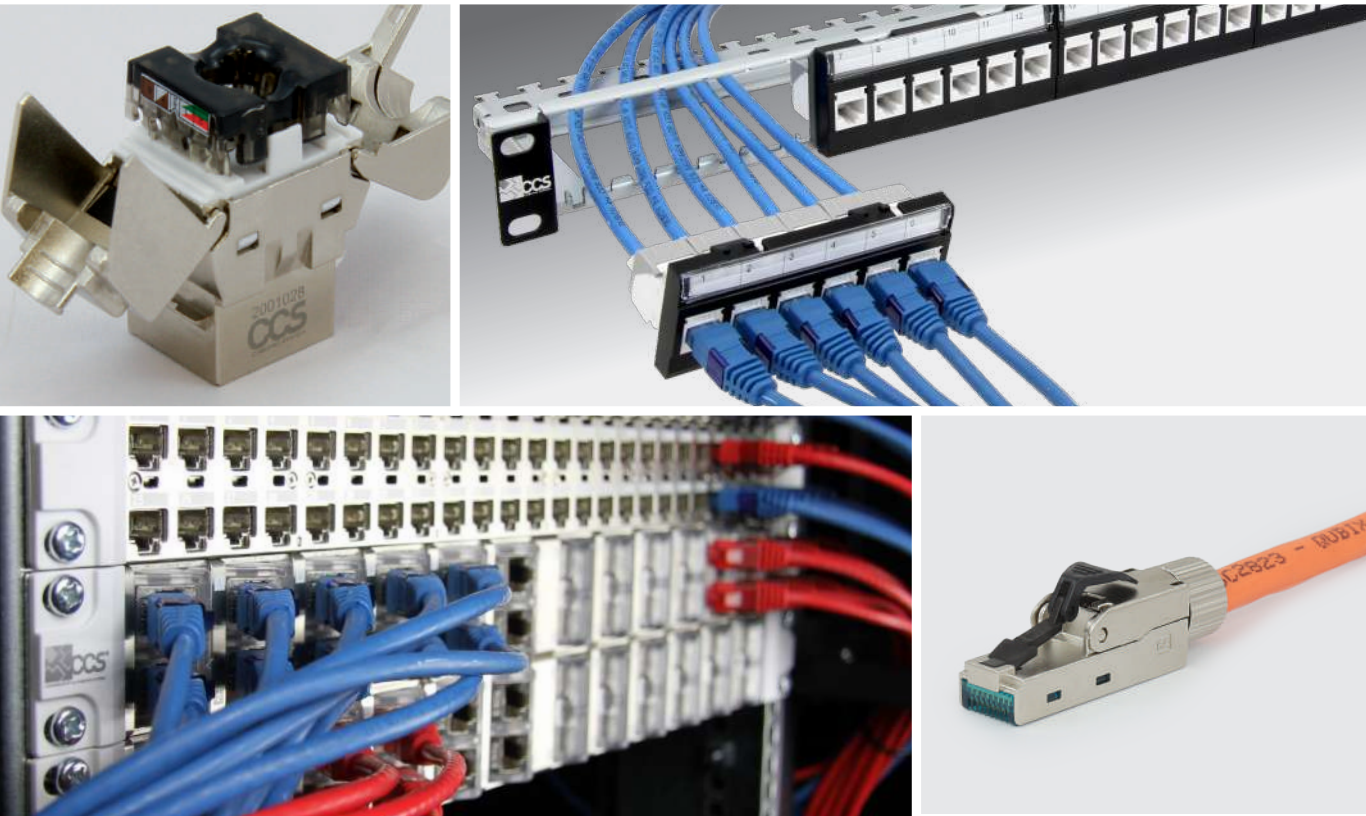

EASY CRIMP COMPACT

Easy Crimp Compact

Developed for new generation networking and multimedia applications and to satisfy more demanding electrical and transmission performance requirements in high density environments, the Easy Crimp Compact cabling system of Category 6, 6A and 6_A maintains high transmission properties in a very compact size which allows installation in high density patch panels. The Easy Crimp Compact snap-in quick system grants high speed of operation and rapid execution of the termination without the use of crimp and impact tools, thus granting installation costs much lower than those of more traditional systems.

Category 6	p. 36
Category 6 _A	p. 38
Patch Panels	p. 41
Field Plugs	p. 46

Easy Crimp Compact

Category 6

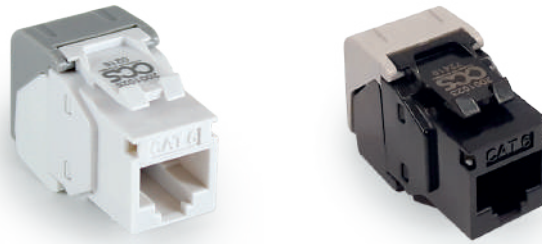

Jacks



Description

CAT 6 Component CCS RJ45 unshielded jack for the realization of Class E transmission channels. The toolless "Easy Crimp Compact" termination system makes the connection very easy and time saving. Certified by independent labs in accordance with Cat. 6 requirements on the single component, it supports 10Gigabit Ethernet (IEEE 802.3an) and is suitable for PoE/PoE+/PoE++ applications.

Performance

Certifications	Force Technology Category 6 Component Level
Standards	ISO/IEC 11801 1/2:2017 IEC 60603-7-4:2010 EN 50173-1/2:2018 ANSI/TIA-568.2-D IEC 60512-99-002:2019
Warranty	25 years on CCS® system

General characteristics

Material	Polycarbonate, flame-retardant plastic housing with high mechanical resistance, 8 nickel bronze contacts plated with 50 µm hard gold.
Connections	IDC insulation displacement for solid or stranded copper conductors from 22 to 26 AWG; double labelling colour scheme T568A/B, reusable wire organizer, toolless closing by snap-in termination flaps.
Installation	Keystone universal for installation on panels, faceplates, civil series adapters and outdoor boxes
Colour	Housing : White/Black Termination flaps: Grey

TERMINATION PROCEDURE

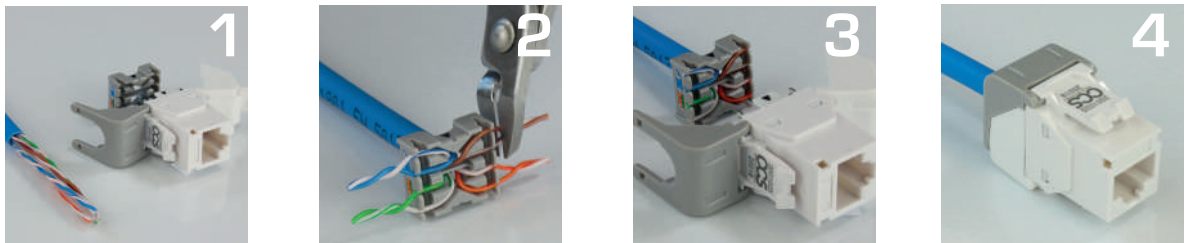

Code	Description	Packaging
2001023	CCS Easy Crimp Compact CAT6 UTP RJ45 jack - Component - Black	60 pcs
2001025	CCS Easy Crimp Compact CAT6 UTP RJ45 jack - Component - White	60 pcs

Easy Crimp Compact

Category 6



EASY CRIMP COMPACT

Patch panels



Description

CCS 24-port patch panel with 4 removable modules of 6 ports each, supplied with 24 Cat. 6 CCS® “Easy Crimp Compact” unshielded RJ45 jacks (Code 2002051) or blank (Code 2002013). Suitable for transmission channels of Class E. The “Easy Crimp Compact” termination system makes the connection fast and easy without the use of tools allowing a considerable time saving during the installation phase. Certified by independent testing laboratories in accordance with Cat. 6 requirements on the single component, they support 10Gigabit Ethernet (IEEE 802.3an) and are suitable for PoE/PoE+/PoE++ applications.

Performance

Certifications	Force Technology Category 6 Component Level
Approvals	ISO/IEC 11801-1/2:2017 IEC 60603-7-4:2010 EN 50173-1/2:2018 ANSI/TIA-568.2-D IEC 60512-99-002:2019
Warranty	25 years on CCS® system

General characteristics

Structure	Metal frame, 4 removable plastic modules of 6 blank Keystone compatible ports, suitable for the frontal installation of CCS RJ45 jacks, transparent plastic label holders, integrated rear cable management
Equipment	1 CCS patch panel with 4 removable modules of 6 ports each; 24 Cat. 6 “Easy Crimp Compact” unshielded RJ45 jacks (Code 2002051); labels for the custom numbering; rack mount screws and nuts, cable ties
Dimensions	19”, 1 Unit
Colour	Black



Code	Description	Packaging
2002013	CCS Easy Crimp Compact 24 port blank modular patch panel	1 pc
2002051	CCS Easy Crimp Compact 24 port modular patch panel with 24 CAT6 UTP Easy Crimp Compact RJ45 jacks	1 pc

Easy Crimp Compact

Category 6_A

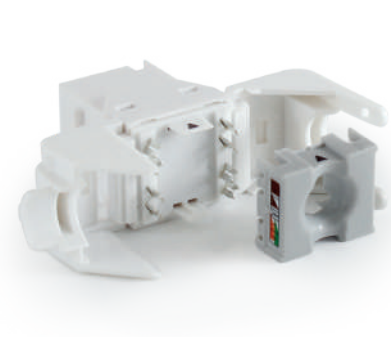

Jacks

Description

CAT 6A Component CCS RJ45 unshielded jack for the realization of Cat.6A/Class EA transmission channels. The toolless "Easy Crimp Compact" termination system makes the connection very easy and time saving. Certified by independent labs in accordance with Cat. 6A requirements on the single component, it supports 10Gigabit Ethernet (IEEE 802.3an) and is suitable for PoE/PoE+/PoE++ applications.

Performance

Compliance	Force Technology Category 6A Component Level
Standards	ISO/IEC 11801-1/2:2017 IEC 60603-7-41:2010; EN 50173-1/2:2018; ANSI/TIA-568.2-D; IEC 60512-99-002:2019
Warranty	30 years on CCS® system

General characteristics

Material	Polycarbonate, flame-retardant plastic housing with high mechanical resistance, 8 nickel bronze contacts plated with 50 µm hard gold.
Connections	IDC insulation displacement for solid or stranded copper conductors 22 to 26 AWG; double labelling colour scheme T568A/B, reusable wire organizer, toolless closing by snap-in termination flaps.
Installation	Keystone universal for installation on panels, faceplates, civile series adapters and outdoor boxes
Colour	White

Code	Description	Packaging
2001027	CCS Easy Crimp Compact CAT6A UTP RJ45 jack - Component	24 pcs

Easy Crimp Compact

Category 6A

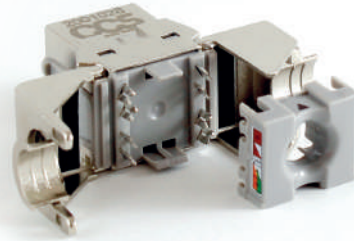

Jacks



Description

CAT 6A Channel CCS RJ45 shielded jack for the realization of Cat.6A/Class E_A transmission channels. Thanks to its reduced dimensions, it is suitable for high density installation solutions and can be installed on 1U – 48 positions (Code 2002049) and ½U – 24 positions (Code 2002048) CCS Compact patch panels. The toolless "Easy Crimp Compact" termination system makes the connection very easy and time saving. Certified in accordance with Class E_A requirements on the channel link, it supports 10Gigabit Ethernet (IEEE 802.3an) and is suitable for POE/PoE+/PoE++ applications.

Performance

Compliance	Cat.6A/Class E _A
Standards	ISO/IEC 11801-1/2:2017 EN 50173-1/2:2018 ANSI/TIA-568.2-D IEC 60512-99-002:2019
Warranty	25 years on CCS® system

General characteristics

Material	Die-cast metal housing, high impact, 8 nickel bronze contacts plated with 50 µm hard gold.
Connection	IDC insulation displacement for solid or stranded copper conductors 22 to 26 AWG; double labelling colour scheme indicating the two T568A/B connections, reusable wire organizer, toolless closing system by snap-in termination flaps.
Installation	Keystone universal for installation on panels, faceplates, civil series adapters and outdoor boxes.
Colour	Metal

Code	Description	Packaging
2001028	CCS Easy Crimp Compact CAT6A Die-cast STP RJ45 jack - Channel	24 pcs

Easy Crimp Compact

Category 6_A



Jacks



Description

CAT 6A Component CCS® RJ45 shielded jack for the realization of Class E_A transmission channels .

Thanks to its reduced dimensions, it is suitable for high density installation solutions and can be installed on 1U – 48 positions (Code 2002049) and ½U – 24 positions (Code 2002048) CCS® high density patch panels.

The toolless “Easy Crimp Compact” termination system makes the connection very easy and time saving.

Certified by independent testing laboratories in accordance with CAT 6A requirements on the single component, it supports 10Gigabit Ethernet (IEEE 802.3an) and is suitable for PoE/PoE+/PoE++ applications.

Performance

Certifications	Force Technology Category 6 _A Component Level
Approvals	ISO/IEC 11801-1/2:2017; IEC 60603-7-51:2010 EN 50173-1/2:2018; ANSI/TIA-568.2-D IEC 60512-99-002:2019
Warranty	30 years on the CCS® system

General characteristics

Material	Die-cast metal housing, high impact, 8 nickel bronze contacts plated with 50 µm hard gold.
Connection	IDC insulation displacement for solid or stranded copper conductors 22 to 26 AWG; double labelling colour scheme for T568A/B connections, reusable wire organizer, toolless closing system by snap-in termination flaps.
Installation	Keystone universal for installation on panels, faceplates, adapters and outdoor boxes.
Colour	Metal

TERMINATION PROCEDURE

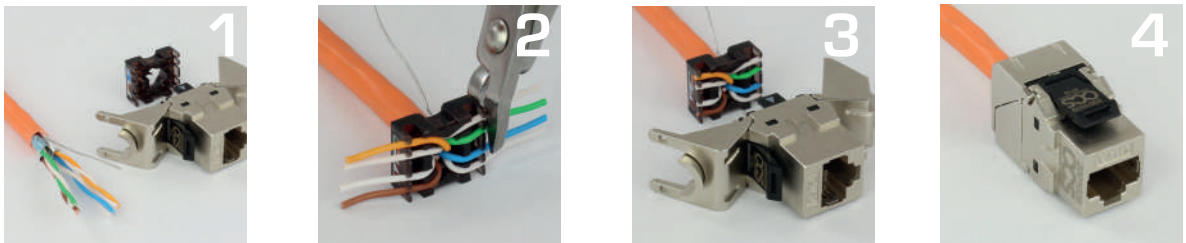

Code	Description	Packaging
2001029	CCS Easy Crimp Compact CAT6A Die-cast STP RJ45 jack - Component	24 pcs

Easy Crimp Compact

Category 6_A

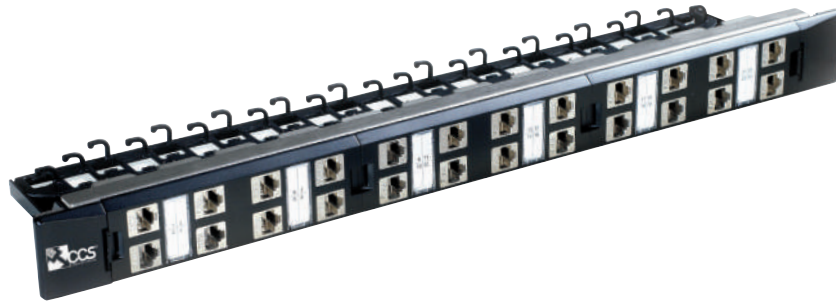

EASY CRIMP COMPACT

Patch panels



Description

CAT 6_A CCS 24-port patch panel, supplied with 24 “Easy Crimp Compact” die-cast shielded RJ45 jacks for transmission channels of Class E_A.

The “Easy Crimp Compact” termination system makes the connection fast and easy without the use of tools allowing a considerable time saving during the installation phase. Certified by independent testing laboratories in accordance with Cat. 6_A requirements on the single component, they support 10Gigabit Ethernet applications (IEEE 802.3an) and are suitable for POE+ (IEEE 802.3at).

Performance

Certifications	Force Technology Category 6 _A Component Level
Approvals	ISO/IEC 11801-1/2:2017 (Ed. 1.0) IEC 60603-7-51:2010; EN 50173-1/2:2018 ANSI/TIA-568.2-D; IEC 60512-99-002:2019
Warranty	30 years on CCS system

Structure	Metal frame with 24 ports for Keystone Easy Crimp jacks; 8 position modules in ABS; mount release lateral screws cover with logos; jacks layout in two rows to exceed the Alien Next requirements; setting for connection to ground.
Equipment	1 CCS 24-port patch panel; 24 CAT 6 _A CCS “Easy Crimp Compact ” die-cast shielded RJ45 jacks; cover for 8/16/24 positions modules; clear plastic label-holder for the personalized numbering; rear cable management; 24 dust-protection caps for the jacks; rack mount screws and nuts, cable ties.
Dimensions	19”, 1 Unit
Colour	Black

Code	Description	Packaging
2002043	CAT 6A CCS 24 ports Easy Crimp Compact shielded RJ45 jacks patch panel	1 pc

Easy Crimp Compact

Patch Panels



24 ports blank patch panel

Description

24-port blank patch panel suitable for keystone standard CCS RJ45 "Easy Crimp" and "Easy Crimp Compact" shielded and unshielded jacks.

Characteristics

Structure	Metal frame with 24 ports for Keystone Easy Crimp and Easy Crimp Compact shielded and unshielded jacks; ABS casing with 8-port cover; mount release lateral screws cover with logos: jacks layout in two rows; metal frame for the shielded jacks grounding.
Equipment	1 CCS 24-port blank patch panel; cover for 8 port-module; clear plastic label-holder; setting for connection to ground; rear cable management.
Dimensions	19", 1Unit
Colour	Black

Code	Description
2002012	Easy Crimp 24-port blank patch panel for CCS jacks

24 ports modular blank patch panel

Description

24-port modular blank patch panel with 4 removable modules of 6 ports each, suitable for keystone standard CCS RJ45 "Easy Crimp Compact" unshielded jacks.

Characteristics

Structure	Metal frame, 4 removable plastic modules of 6 blank Keystone compatible ports, suitable for the frontal installation of CCS RJ45 jacks, transparent plastic label holders, integrated rear cable management.
Equipment	1 CCS patch panel with 4 removable modules of 6 ports each; labels for the custom numbering; rack mount screws and nuts, cable ties
Dimensions	19", 1Unit
Colour	Black

Code	Description
2002013	Easy Crimp Compact 24-port modular blank patch panel

Easy Crimp Compact

Patch Panels



24 ports orientable blank patch panel

Description

24-port blank patch panel with orientable ports suitable for keystone standard CCS RJ45 "Easy Crimp Compact" shielded and unshielded jacks. The orientable ports highly ease the cabling management.

Characteristics

Structure	Metal frame with 24 orientable ports for Keystone "Easy Crimp Compact" shielded and unshielded jacks; jacks layout in two rows; metal frame for the shielded jacks grounding.
Equipment	1 CCS 24-orientable port blank patch panel; labels for port-numbering; rear cable management and cable ties; riveted cable which can be installed on both sides of the panel for the grounding of the jacks
Dimensions	19", 1Unit
Colour	Metal

Performance

Standards	ISO/IEC 11801 EN 50173-1 ANSI/TIA-568.2-D
-----------	---

Code	Description	Packaging
2002047	Easy Crimp 24-orientable port blank panel for CCS jacks	1 pc

Easy Crimp Compact

Patch Panels



24 ports HIGH DENSITY

Description

24-port high density blank patch panel 1/2 U, suitable for keystone standard shielded CCS RJ45 Easy Crimp Compact jacks.

Characteristics

Structure	Steel frame with 24 ports for Keystone Easy Crimp Compact shielded jacks; jacks layout in one row; numbered ports; setting for connection to ground
Equipment	1 CCS 24-port patch panel; labels for port identification; rear cable management with cable ties; riveted cable which can be installed on both sides of the panel for the grounding of the jacks
Dimensions	19", 1/2 Unit
Colour	Metal

Code	Description
2002048	CCS Easy Crimp Compact 24-port blank patch panel 1/2U

48 ports HIGH DENSITY

Description

48-port high density blank patch panel 1U, suitable for keystone standard shielded CCS RJ45 Easy Crimp Compact jacks.

Characteristics

Structure	Steel frame with 48 ports for Keystone Easy Crimp Compact shielded jacks; jacks layout in two rows; numbered ports; setting for connection to ground.
Equipment	1 CCS 48-port patch panel; labels for port identification; rear cable management with cable ties; riveted cable which can be installed on both sides of the panel for the grounding of the jacks
Dimensions	19", 1Unit
Colour	Metal

Code	Description
2002049	CCS Easy Crimp Compact 48-port blank patch panel 1 U

Easy Crimp Compact

Patch Panels

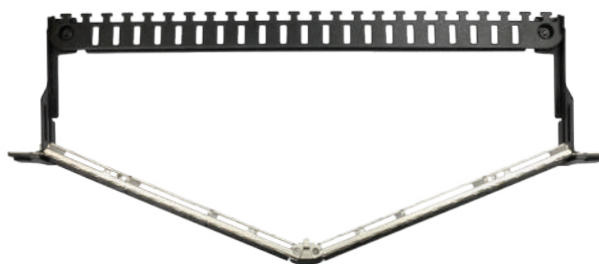

EASY CRIMP COMPACT

Angled patch panel, 48-port, blank

Description

CCS 19" angled high density patch panel, 48-port, blank, compatible with CCS RJ45 Easy Crimp Compact shielded jacks (codes 2001028 - 2001029).

Performances

Standards ISO/IEC 11801
EN 50173-1
ANSI/TIA-568.2-D

Characteristics

Structure CRS frame for grounding of shielded jacks; 48-port standard keystone; numbered ports; rear cable management bar

Packaging 1 CCS angled patch panel 48-port, blank; labels for the numbering of the ports; metal rear cable management; cable ties; earthing kit

Dimensions 19", 1U

Compatibility CCS RJ45 Easy Crimp Compact shielded jacks (codes 2001028 - 2001029)

Colour Frame: metal grey
Cable management: black

Code	Description	Packaging
2002053	CCS Easy Crimp Compact angled patch panel, 48-port, blank, 1U	1 pc

Easy Crimp Compact

Field Plugs



Easy Crimp Compact Cat. 6A UTP

Description

CCS Easy Crimp Compact Cat. 6_A unshielded RJ45 field plug used to terminate cables with solid or stranded conductors. Toolless plugs, no tool is needed for a quick and easy termination.

Ideal for the realization of MPTL connections (Modular Plug Terminated Link) or patch cords of non-standard length. It is compliant to PoE/PoE+/PoE++ applications.

Characteristics

Material	Plug body in PC-FR, 8 contacts phosphor bronze alloy plated with 50µm of gold; steel cable gland
Connection	IDC insulation displacement for solid conductors 23-26 AWG and stranded 23-27 AWG; label indicating T568A/B connection schemes
Installation	On cables with solid and stranded conductors
Cable OD	From 5,5 to 8,5 mm

Performances

Certifications	UL 1863 Communications Circuit Accessories
Standards	ISO/IEC 11801-1/2:2017 EN 50173-1:2018; ANSI/TIA-568.2-D IEC 60603-7-41; IEC 60512-99-002:2019

Code	Description
2012025	Cat 6A UTP Easy Crimp Compact field plug

Easy Crimp Compact Cat. 6A STP

Description

CCS Easy Crimp Compact Cat. 6_A shielded RJ45 field plug used to terminate cables with solid or stranded conductors. Toolless plugs, no tool is needed for a quick and easy termination.

Ideal for the realization of MPTL connections (Modular Plug Terminated Link) or patch cords of non-standard length. It is compliant to PoE/PoE+/PoE++ applications.

Characteristics

Material	Plug body in zinc alloy nickel plated, wire manager in flame retardant polycarbonate UL94 V0; 8 contacts phosphor bronze alloy plated with 50µm of gold; steel cable gland
Connection	IDC insulation displacement for solid conductors 22-26 AWG and stranded 23-27 AWG; label indicating T568A/B connection schemes
Installation	On cables with solid and stranded conductors
Cable OD	From 6 to 9 mm

Performances

Certifications	UL 1863 Communications Circuit Accessories
Standards	ISO/IEC 11801-1/2:2017 EN 50173-1:2018; ANSI/TIA-568.2-D IEC 60603-7-51; IEC 60512-99-002:2019

Code	Description
2012026	Cat 6A STP Easy Crimp Compact field plug

Copper cabling system – Easy Crimp System

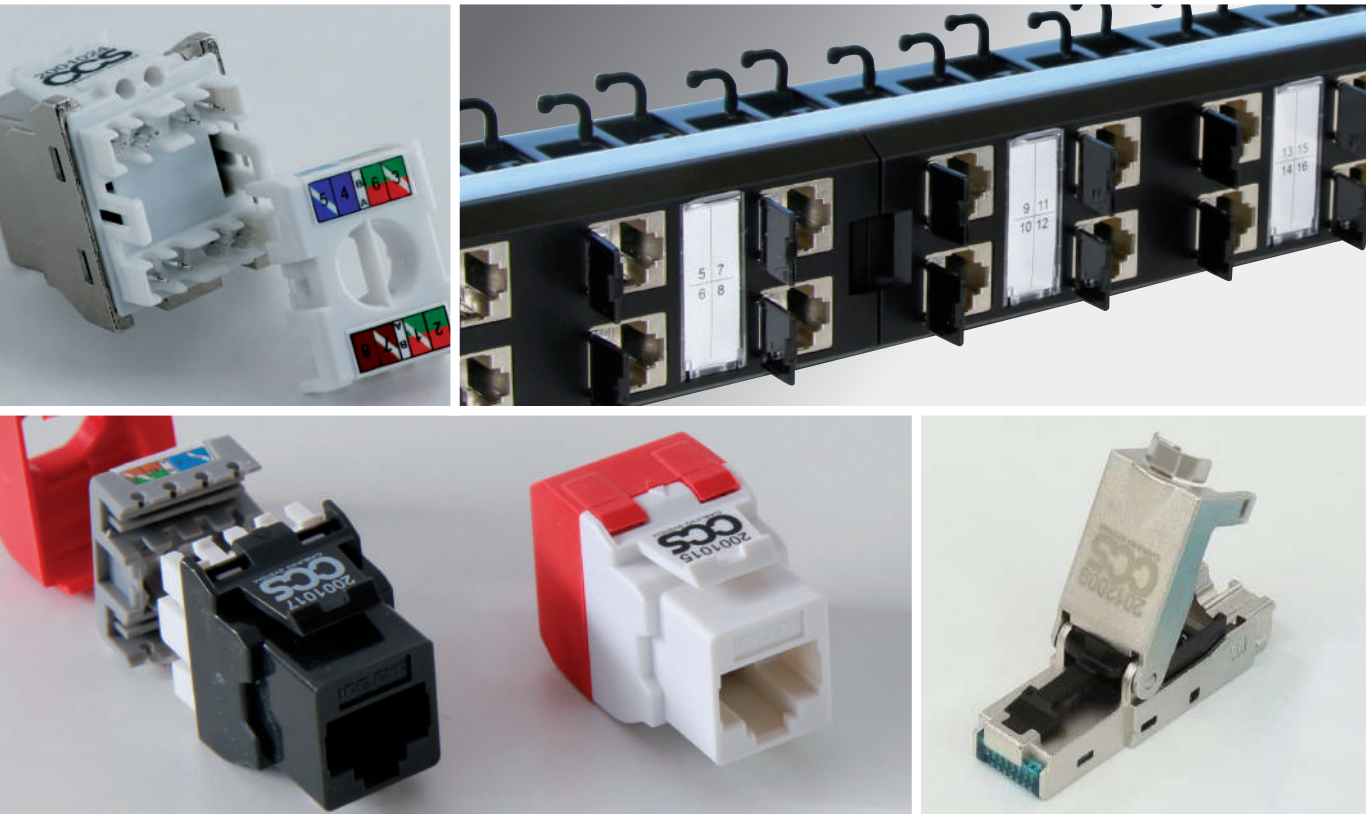

EASY CRIMP

Easy Crimp System

Developed for new generation networking and multimedia applications and to satisfy highly demanding electrical and transmissive performance requirements, the Easy Crimp cabling systems of Category 5E, 6 and 6A Channel provide the best performances in terms of reliability, longevity and transmission properties.

The unique Easy Crimp snap-in quick system allows high speed of operation and rapid execution of the termination without the use of impact tools, thus granting installation costs lower than those of more traditional systems.

Category 5E	p. 48
Category 6A Channel	p. 50
Field-plugs	p. 52
Coupler	p. 54
Coupler patch panel	p. 55
Accessories	p. 56

Easy Crimp System

Category 5E

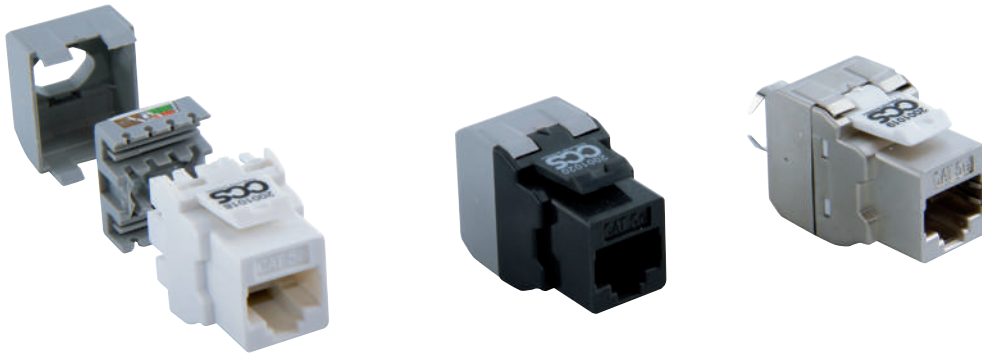

Jacks



Description

CAT 5E CCS shielded and unshielded RJ45 jacks for transmission channels of Class D.
 The “Easy Crimp” termination system makes the connection fast and easy without the use of tools allowing a considerable time saving during the installation phase.
 Certified by independent testing laboratories in accordance with CAT 5E requirements on the single component, they support Gigabit Ethernet (IEEE 802.3ab) and are suitable for PoE/PoE+ applications.

Performance

Certifications	Force Technology Category 5E Component Level
Approvals	ISO/IEC 11801 1/2:2017 IEC 60603-7-2:2010; EN 50173-1/2:2018 ANSI/TIA-568.2-D; IEEE 802.3at
Warranty	20 years on CCS® system

General characteristics

Material	Polycarbonate, high-impact, flame-retardant plastic housing, metal coated (only for the shielded version). 8 nickel bronze contacts plated with 50 µm hard gold.
Connection	Reusable connection cap with ergonomic slots to facilitate the conductors positioning; IDC insulation displacement for solid or stranded copper conductors of diameter from 22 to 26 AWG; double labelling colour scheme indicating the two T568A/B connections, external cap for the termination protection.
Installation	Keystone universal snap-in for installation on panels, faceplates, civil series adapters and outdoor boxes.
Colour	Shielded version: Aluminum Grey Unshielded version: White/Anthracite

TERMINATION PROCEDURE

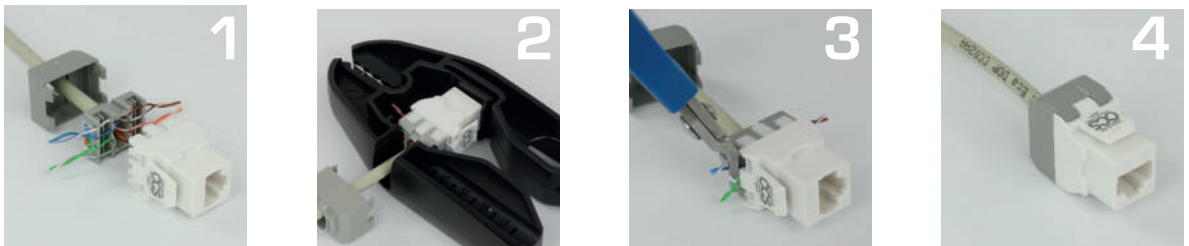

Code	Description	Packaging
2001019	CAT5E CCS Easy Crimp shielded RJ45 jack	60 pcs
2001020	CAT5E CCS Easy Crimp unshielded RJ45 jack - anthracite	60 pcs
2001018	CAT5E CCS Easy Crimp unshielded RJ45 jack - white	60 pcs

Easy Crimp System

Category 5E



EASY CRIMP

Patch panels



Description

CAT 5E CCS 24-port patch panel, supplied with 24 “Easy Crimp” shielded or unshielded RJ45 jacks for transmission channels of Class D.

The “Easy Crimp” termination system makes the connection fast and easy without the use of tools allowing a considerable time saving during the installation phase.

Certified by independent testing laboratories in accordance with CAT 5E requirements on the single component, they support Gigabit Ethernet (IEEE 802.3ab) and are suitable for PoE/PoE+ applications.

Performance

Certifications Force Technology
Category 5E Component Level

Approvals ISO/IEC 11801 1/2:2017
IEC 60603-7-2:2010/IEC 60603-7-3:2010
EN 50173-1/2:2018
ANSI/TIA-568.2-D
IEEE 802.3at

Warranty 20 years on CCS® system

General characteristics

Structure Metal frame with 24 ports for Keystone Easy Crimp jacks; ABS casing with 8-position covers; mount release lateral screws cover with logos; jacks layout in two rows; setting for connection to ground.

Equipment 1 CCS 24-port patch panel; 24 CAT 5E CCS “Easy Crimp” shielded or unshielded RJ45 jacks; frontal cover for 8 port-module; clear plastic label-holder for the custom numbering; rear cable management; 24 dust-protection caps for the jacks; rack mount screws and nuts, cable ties.

Dimensions 19”, 1 Unit

Colour Black

Code	Description	Packaging
2002036	CAT 5E CCS 24 ports Easy Crimp shielded RJ45 jacks patch panel	1 pc
2002035	CAT 5E CCS 24 ports Easy Crimp unshielded RJ45 jacks patch panel	1 pc

Easy Crimp System

Category 6A Channel

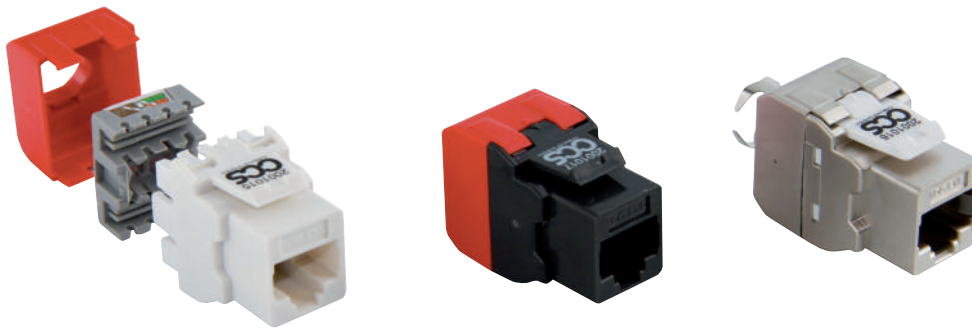

Jacks



Description

CAT 6A-10G CCS shielded and unshielded RJ45 jacks for transmission channels of Class E_A.
 The “Easy Crimp” termination system makes the connection fast and easy, without the use of tools allowing a considerable time saving during the installation phase.
 Certified by independent testing laboratories in accordance with Class E_A requirements on the channel link at 500 Mhz and with CAT 6 requirements on the single component, they support 10Gigabit Ethernet (IEEE 802.3an) and are suitable for PoE/PoE++ applications

Performance

Certifications Force Technology
 Channel Class E_A for the shielded version
 Category 6 Component Level

Approvals ISO/IEC 11801 1/2:2017
 IEC 60603-7-4/5:2010; EN 50173-1/2:2018
 ANSI/TIA-568.2-D; IEC 60512-99-002:2019

Warranty 25 years on CCS® system

General characteristics

Material Polycarbonate, high-impact, flame-retardant plastic housing, metal coated (only for the shielded version). 8 nickel bronze contacts plated with 50 µm hard gold.

Connection Reusable connection cap with ergonomic slots to ease the conductors positioning; IDC insulation displacement for solid or stranded copper conductors diameter 22-26 AWG; double labelling colour scheme indicating the two T568A/B connections, external cap for the termination protection.

Installation Keystone universal snap-in for installation on panels, faceplates, civil series adapters and outdoor boxes.

Colour Unshielded version: White/Anthracite
 Shielded version: Aluminum Grey

TERMINATION PROCEDURE

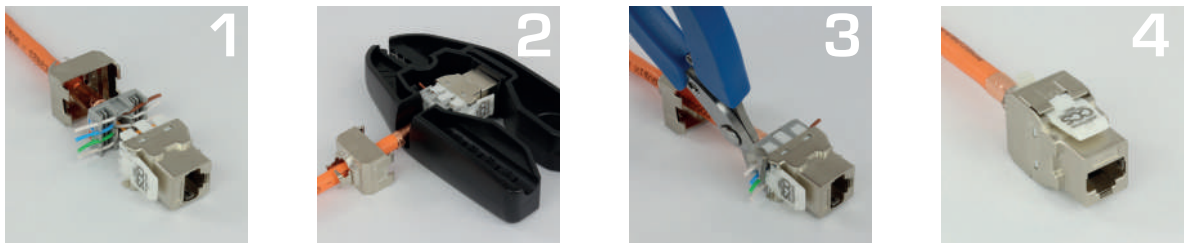

Code	Description	Packaging
2001016	CAT 6A Channel 10G.EXE CCS Easy Crimp shielded RJ45 jack	60 pcs
2001017	CAT 6A Channel 10G.EXE CCS Easy Crimp unshielded RJ45 jack-Anthracite	60 pcs
2001015	CAT 6A Channel 10G.EXE CCS Easy Crimp unshielded RJ45 jack-White	60 pcs

Easy Crimp System

Category 6A Channel



EASY CRIMP

Patch panels



Description

CAT 6A-10G CCS 24-port patch panel, supplied with 24 “Easy Crimp” shielded or unshielded RJ45 jacks for transmission channels of Class E_A.
 The “Easy Crimp” termination system makes the connection fast and easy without the use of tools allowing a considerable time saving during the installation phase.
 Certified by independent testing laboratories in accordance with Class E_A requirements on the channel link at 500 Mhz and with CAT 6 requirements on the single component, they support 10Gigabit Ethernet (IEEE 802.3an) and are suitable for PoE/PoE+/PoE++ applications.

Performance

Certifications	Force Technology Channel Class E _A for the shielded version Category CAT 6 Component Level
Approvals	ISO/IEC 11801-1/2:2017 IEC 60603-7-4:2010/IEC 60603-7-5:2010 EN 50173-1/2:2018 ANSI/TIA-568.2-D IEC 60512-99-002:2019
Warranty	25 years on CCS® system

General characteristics

Structure	Metal frame with 24 ports for Keystone Easy Crimp jacks; ABS casing with 8-port covers; mount release lateral screws cover with logos; jacks layout in two rows; setting for connection to ground.
Equipment	1 CCS 24-port patch panel; 24 CAT 6A-10G.EXE CCS “Easy Crimp” shielded or unshielded RJ45 jacks; frontal cover for 8 port-module; clear plastic label-holder for the custom numbering; rear cable management; 24 dust-protection caps for the jack; rack mount screws and nuts, cable ties.
Dimensions	19”, 1 Unit
Colour	Black

Code	Description	Packaging
2002038	CAT 6A-10G.EXE Channel 24 ports Easy Crimp shielded RJ45 jacks patch panel	1 pc
2002037	CAT 6A-10G.EXE Channel 24 ports Easy Crimp unshielded RJ45 jacks patch panel	1 pc

Easy Crimp System

Field Plugs

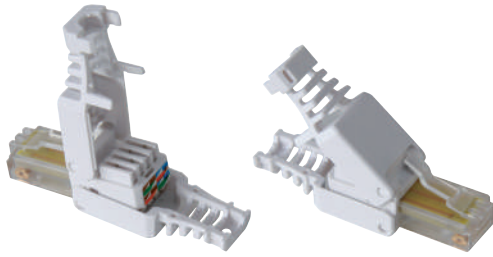

Easy Crimp CAT 5E UTP

Description

CCS unshielded plug used to connect cables with solid conductors.

With the tool-less Easy Crimp system, the connection is always fast and performing.

Ideal for the realization of "transition point" or patch cords out of standard length.

Characteristics meet and exceed CAT 5E - Class D requirements according to ISO/IEC 11801 and ANSI/TIA 568.2-D

Characteristics

Material	Flame retardant thermoplastic material with high mechanical resistance; 8 nickel bronze contacts plated with 50 µm hard gold
Connection	IDC insulation displacement for solid copper conductors from 23 to 24 AWG; double labelling colour scheme indicating the two T568A/B connections
Installation	On cables with solid conductors

Performance

Compliance	Category 5E – Class D
Approvals	ISO/IEC 11801-1/2:2017 EN 50173-1:2011 ANSI/TIA-568.2-D

Code	Description
2012003	CAT5E UTP Easy Crimp plug

Easy Crimp CAT 6 UTP

Description

CCS Easy Crimp unshielded plug used to connect cables with solid and flexible conductors.

With the toolless Easy Crimp system, the connection is always fast and performing. Ideal for the realization of the modular plug terminated link (MPTL), "transition point" or patch cords out of the standard lengths. Characteristics meet and exceed CAT 6 - Class E requirements according to ISO/IEC 11801 and ANSI/TIA-568.2-D. Suitable for PoE/PoE+/PoE++ applications.

Characteristics

Material	Flame retardant polycarbonate with high mechanical resistance; 8 nickel bronze contacts plated with 50 µm hard gold
Connection	IDC insulation displacement for solid copper conductors 22-26 AWG and flexible conductors 22-27 AWG; double labelling colour scheme indicating the two T568A/B connections
Installation	On cables with solid and flexible conductors
Compatible cable diameter	From 6 to 9 mm

Performance

Compliance	UL 1863 Communications-Circuit Accessories
Approvals	ISO/IEC 11801-1/2:2017 EN 50173-1/2:2018; ANSI/TIA-568.2-D IEC 60603-7-4; IEC 60512-99-002:2019

Code	Description
2012007	CAT6 UTP Easy Crimp field plug

Easy Crimp System

Field Plugs



EASY CRIMP

Easy Crimp CAT 6 STP

Description

CCS Easy Crimp shielded plug used to connect cables with solid and flexible conductors. With the toolless Easy Crimp system, the connection is always fast and performing. Ideal for the realization of the modular plug terminated link (MPTL), "transition point" or patch cords out of the standard lengths. Characteristics meet and exceed CAT 6 - Class E requirements according to ISO/IEC 11801 and ANSI/TIA-568.2-D. Suitable for PoE/PoE+/PoE++ applications.

Characteristics

Material	Plug housing in zinc alloy with high mechanical resistance; 8 nickel bronze contacts plated with 50 µm hard gold
Connection	IDC insulation displacement for solid copper conductors 22-26 AWG and flexible conductors 22-27 AWG; double labelling colour scheme indicating the two T568A/B connections
Installation	On cables with solid and flexible conductors
Compatible cable diameter	From 6 to 9 mm

Performance

Compliance	UL 1863 Communications-Circuit Accessories
Approvals	ISO/IEC 11801-1/2:2017 EN 50173-1/2:2018; ANSI/TIA-568.2-D IEC 60603-7-5; IEC 60512-99-002:2019

Code	Description
2012008	CAT6 STP Easy Crimp field plug

Easy Crimp CAT 6A STP

Description

CCS Easy Crimp shielded plug used to connect cables with solid and flexible conductors. With the toolless Easy Crimp system, the connection is always fast and performing. Ideal for the realization of the modular plug terminated link (MPTL), "transition point" or patch cords out of the standard lengths. Characteristics meet and exceed Cat.6A - Class EA requirements according to ISO/IEC 11801 and ANSI/TIA-568.2-D. Suitable for PoE/PoE+/PoE++ applications

Characteristics

Material	Plug housing in zinc alloy with high mechanical resistance; 8 nickel bronze contacts plated with 50 µm hard gold
Connection	IDC insulation displacement for solid copper conductors 22-26 AWG and flexible conductors 22-27 AWG; double labelling colour scheme indicating the two T568A/B connections
Installation	On cables with solid and flexible conductors
Compatible cable diameter	From 6 to 9 mm

Performance

Compliance	UL 1863 Communications-Circuit Accessories
Standards	ISO/IEC 11801-1/2:2017 EN 50173-1/2:2018; ANSI/TIA-568.2-D IEC 60603-7-4; IEC 60512-99-002:2019

Code	Description
2012009	CAT6A STP Easy Crimp field plug

Easy Crimp System

Coupler

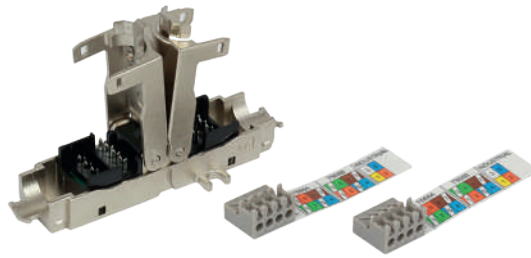

In-line coupler Cat. 6A STP

Description

CCS in-line coupler Category 6_A shielded, ideal to extend existing copper links.
Toolless termination system for a quick and easy termination.
It complies with Cat. 6_A Class E_A performances, standard ISO/IEC 11801, EN 50173 and ANSI/TIA 568.2-D.

Characteristics

Material	Housing in zinc-alloy nickel plated; wire manager in PC-FR, flame retardant polycarbonate UL94 V0; IDC contacts in phosphor bronze tin plated
Connection	IDC termination; for solid copper conductors 22-26 AWG; double label with colour scheme T568A/B
Installation	On cables with solid conductors
Cable OD	From 6 to 9 mm

Performance

Certifications	Category 6 _A - Class E _A
Standards	ISO/IEC 11801-1/2:2017 EN 50173-1/2:2018 ANSI/TIA-568.2-D

Code	Description	Packaging
2012027	In-line coupler Easy Crimp RJ45 Cat. 6A shielded	1 pc

Easy Crimp System

Coupler Patch panel

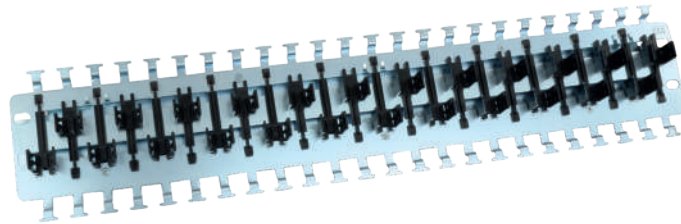

Patch panel for inline-couplers

Description

CCS 19" patch panel suitable for the installation up to no. 24 Easy Crimp couplers Cat 6_A for copper cables (P/N 2012027). Ideal to extend existing copper links.

Characteristics

Structure	Steel frame for the earthing of the couplers; no. 24 plastic holders
Installation	On 19" racks
Dimensions	19", 2U
Compatibility	Suitable for Easy Crimp in-line couplers Cat 6 _A STP shielded (P/N 2012027)
Colour	Metal grey

Performance

Standards	ISO/IEC 11801-1/2:2017 EN 50173-1/2:2018 ANSI/TIA-568.2-D
-----------	---

Code	Description	Packaging
2002055	CCS patch panel 19" for in-line Easy Crimp couplers	1 pc

Easy Crimp System

Accessories

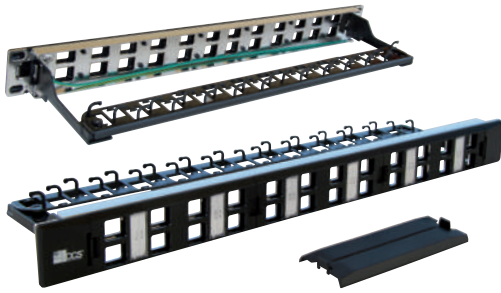

24-port blank patch panel

Crimp tool

Nippers

Description

24-port blank patch panel suitable for keystone standard CCS RJ45 "Easy Crimp" and "Easy Crimp Compact" shielded and unshielded jacks.

Description

Tool useful for the cable preparation and termination. Helpful for cutting the cable jacket and pressing the protection cap on the Easy Crimp jacks.

Description

Flat blade nippers to cut the excess lengths of the cable conductors after CCS Easy Crimp jacks crimping.

Characteristics

Structure	Metal frame with 24 ports for Keystone Easy Crimp shielded and unshielded jacks; ABS casing with 8-port covers; mount release lateral screws cover with logos; jacks layout in two rows; metal frame for the shielded jacks grounding
Equipment	1 CCS 24-port blank patch panel; cover for 8 port-module; clear plastic label-holder; setting for connection to ground; rear cable management
Dimensions	19", 1Unit
Colour	Black

Characteristics

Material	Thermoplastic , high impact, flame-retardant material
Mechanical features	Pressure system for the protection of the cap closing; length-reference for the cable jacket cutting; blade inserts for cables with higher/lower diameter
Colour	Black

Characteristics

Material	Made of steel; handles in thermoplastic material
Mechanical features	Spring return to the opening position; flat blade for precise cable cutting
Colour	Light blue handles

Code	2002012
Description	24-port blank patch panel for CCS Easy Crimp jacks

Code	2004095
Description	Crimp tool for CCS Easy Crimp jacks

Code	2004094
Description	Flat blade nippers for CCS Easy Crimp jacks

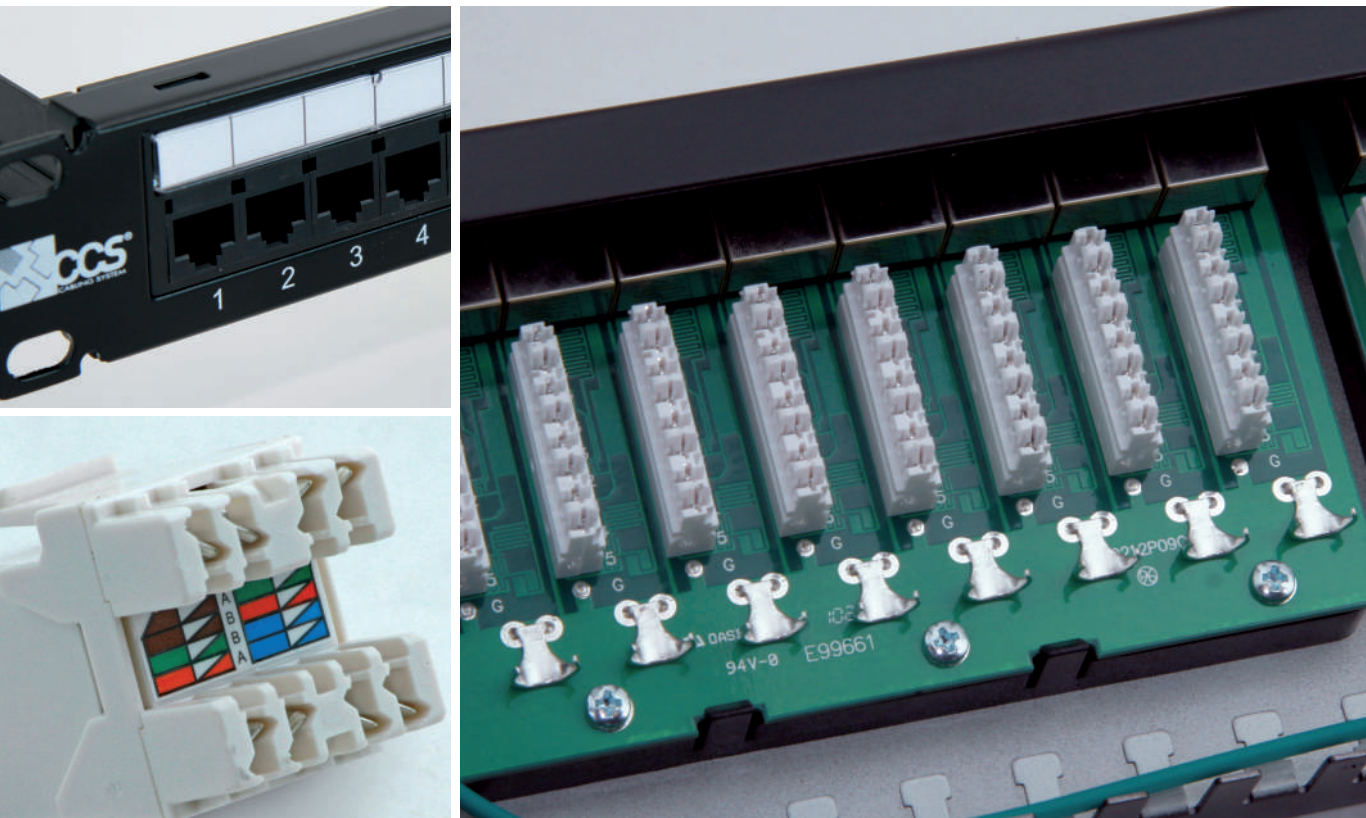

110 cabling system

The CCS® 110 cabling system includes patch panels and Accessories of CATEGORY 5e and 6. The IDC 110 termination is made by using a suitable impact tool.

Category 5E	p. 58
Category 6	p. 59
Voice system	p. 60
Accessories	p. 61

110 cabling system

Category 5E



Patch Panel

Description

CAT 5E CCS 24-port patch panel, preloaded with 24 shielded or unshielded RJ45 jacks with IDC 110 termination system for transmission channels of Class D.

Characteristics meet and exceed CAT 5E – Class D requirements up to 100MHz according to the ISO/IEC 11801 and ANSI/TIA 568.2-D standards.

They support Gigabit Ethernet (IEEE 802.3ab) applications and are suitable for PoE (IEEE 802.3af) applications.

General characteristics

Structure	Metal frame with 4 modules with 6 ports or with 3 modules with 8 ports (only shielded version)
Equipment	1 CCS 24-port patch panel preloaded with 24 CAT 5E CCS shielded or unshielded RJ45 jacks; labels-holder with transparent window (UTP) or preprinted window (STP) for the customized numbering; support and ties for cable fixing
Dimensions	19", 1 Unit
Colour	Black

Performance

Compliance	Category 5E - Class D
Approvals	ISO/IEC 11801-1/2:2017 EN 50173-1/2:2018 ANSI/TIA-568.2-D IEEE 802.3af
Warranty	15 years on the CCS system

Code	Description	Packaging
2002023	CCS 24-port patch panel with 24 Cat.5E shielded RJ45 jacks-IDC 110 system	1
2002021	CCS 24-port patch panel with 24 Cat.5E unshielded RJ45 jacks-IDC 110 system	1

110 cabling system

Category 6



Patch Panel

Description

CAT6 CCS 24-port patch panel, preloaded with 24 unshielded RJ45 jacks with IDC 110 termination system for transmission channels of Class E.
Characteristics meet and exceed CAT 6 – Class E requirements up to 250MHz according to the ISO/IEC 11801 and ANSI/TIA 568.2-D standards.
They support Gigabit Ethernet (IEEE 802.3ab) applications and are suitable for PoE/PoE+/PoE++.

General characteristics

Structure	PC+ABS frame
Equipment	1 CCS 24-port patch panel preloaded with 24 CAT 56 CCS unshielded RJ45 jacks; labels-holder with transparent window for the customized numbering; rear metal support and ties for cable fixing
Dimensions	19", 1 Unit
Colour	Black

Performance

Certifications	UL 1863 Communications Circuit Accessories
Standards	ISO/IEC 11801-1/2:2017 EN 50173-1/2:2018; ANSI/TIA-568.2-D IEC 60512-99-002:2019

Code	Description	Packaging
2002027	CCS 24-port patch panel with 24 Cat.6 unshielded RJ45 jacks	1

110 cabling system

Voice system

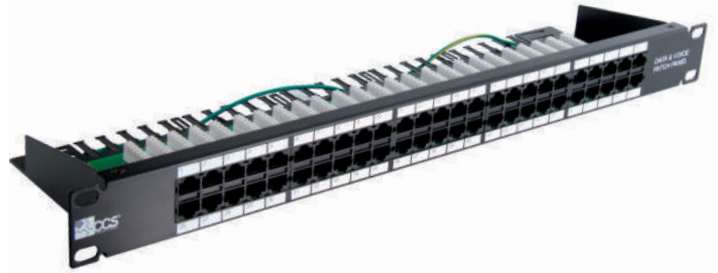
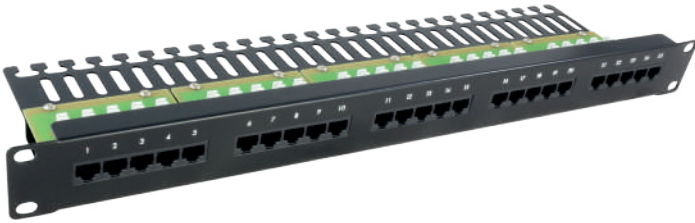

IDC Voice patch panel – 25 ports

Description

CAT 3 CCS 25-port voice patch panel, preloaded with 25 unshielded 4-pin RJ45 jacks with IDC 110 termination system.

Characteristics

Structure	Steel frame, 25 ports modularity, 5 modules with 5 ports each, rear cable management
Jacks	25 pre-installed CAT 3 4-pin RJ45 unshielded jacks with IDC 110 termination system
Dimensions	19", 1U
Colour	Black

Performances

Standards	ISO/IEC 11801-1/2:2017 EN 50173-1:2018 ANSI/TIA-568.2-D
-----------	---

Code	Description
2002028	IDC Voice patch panel – 25 RJ45 ports

IDC Voice patch panel – 50 ports

Description

CAT 3 CCS 50-port voice patch panel, preloaded with 50 unshielded 6-pin RJ45 jacks with IDC 110 termination system.

Characteristics

Structure	Steel frame, 50 ports modularity, 5 modules with 10 ports each, rear cable management
Jacks	50 pre-installed CAT 3 6-pin RJ45 unshielded jacks with IDC 110 termination system
Dimensions	19", 1U
Colour	Black

Performances

Standards	ISO/IEC 11801-1/2:2017 EN 50173-1:2018 ANSI/TIA-568.2-D
-----------	---

Code	Description
2002029	IDC voice patch panel - 50 RJ45 ports

110 cabling system

Accessories



2-pair telephone patch cord

Description

CCS telephone RJ45-RJ45 unshielded patch cord, with blue cable and interchangeable colored clips.

Characteristics

Plug type	RJ45 plug (2 pairs)
Contacts	Phosphor bronze alloy plated with 50µm of gold
Cable	U/UTP, unshielded 2-pair cable (100 Ohm), AWG 24/7 flex bare copper conductors
Jacket	PVC
Colour	Blue
Length	2 mt

Performances

Standards	ISO/IEC 11801-1/2:2017 EN 50173-1:2018 ANSI/TIA-568.2-D
-----------	---

Code	Description
2005010	RJ45-RJ45 2 pair UTP telephone patch cord - 2 mt

Impact tool

Description

Tool to connect twisted pair cable on terminals type 110. Allows the simultaneous insertion of the conductor and the cutting of the excess part.









Are also available as accessories the base finger guard (cod. 2004011) that allows the positioning of the RJ45 sockets for easy termination of the same and a spare blade (cod 2004015).

Characteristics

Material	Thermoplastic flame retardant material with high mechanical resistance
Application	Connection of wires on 110 terminals
Mechanical features	Wheel for the regulation of impact pressure
Color	Yellow

Code	Description
2004018	Impact tool for IDC 110 termination system

Copper cabling system – Compatibility RJ45 jacks and patch panels

Compatibility RJ45 jacks and panels Check the compatibility between the different blank patch panels and the RJ45 jacks of Easy Crimp Compact and Easy Crimp series	EASY CRIMP COMPACT Enterprise		EASY CRIMP Commercial	
	 2001025 2001023 2001027	 2001029 2001028	 2001015 2001017 2001018 2001020	 2001016 2001019
 2002012 Patch panel 24 ports - 1U	✓	✓	✓	✓
 2002013 Modular patch panel 24 ports - 1U	✓	✗	✗	✗
 2002047 24 orientable ports - 1U	✓	✓	✗	✗
 2002048 High density 24 ports - 1/2U	✗	✓	✗	✗
 2002049 High density 48 ports - 1U	✗	✓	✗	✗
 2002053 Angled patch panel 48 ports - 1U	✗	✓	✗	✗



Patch cords and plugs

CCS® patch cords are available in Category 5E, 6 and 6_A, unshielded or shielded, they are supplied with interchangeable coloured clips for identification and are individually tested according to the international ISO/IEC 11801, EN 50173, ANSI/TIA 568 standards.

Category 5E	p. 64
Category 6	p. 65
Category 6 _A	p. 66
Plugs	p. 67
Accessories	p. 68

Patch cords and plugs

Category 5E

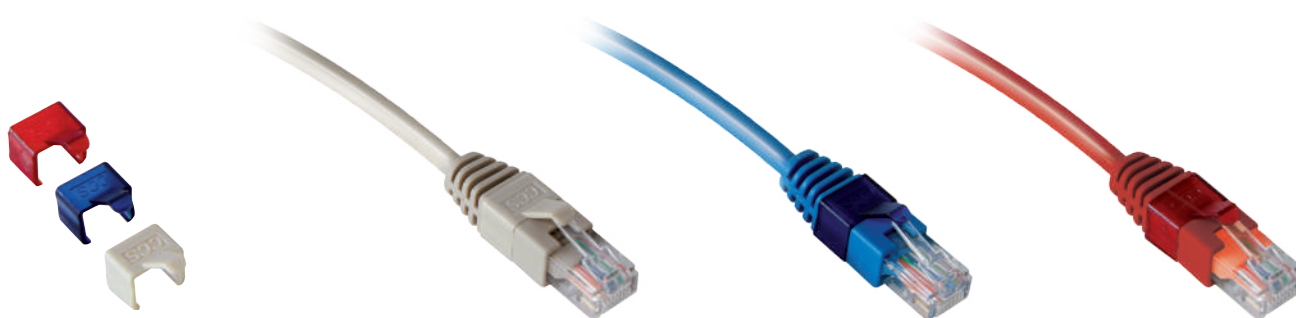

Patch cords

Description

CAT 5E CCS RJ45-RJ45 shielded or unshielded patch cord, with interchangeable coloured clips.
 Characteristics meet and exceed CAT 5E - Class D requirements up to 100 Mhz according to ANSI/TIA 568.2-D and ISO/IEC 11801.
 Ideal for Gigabit Ethernet (IEEE 802.3ab) applications.

Performance

Compliance	CAT 5E – Class D
Approvals	ISO/IEC 11801-1/2:2017 EN 50173-1/2:2018 ANSI/TIA 568.2-D

General characteristics

Material	U/UTP or F/UTP cable shielded with AL/PET tape, 100 Ohm, 4 balanced pairs, AWG 24/7 (UTP version) or AWG26/7 (FTP version) bare copper flexible conductors; PVC outer jacket; RJ45 plug with 8 nickel bronze contacts plated with 50 µm hard gold
Connection	Thermo-sealed protection cap; insulation displacement according to IEC 60352-4; T568B wiring diagram; grey, blue, red, interchangeable clips for easy application identification
Applications	Permanent connections between active transmission equipments and patch panels; interconnections between panels
Packaging	Every patch cord is individually packed
Colour	Blue RAL 5015, Grey RAL 7032 or Red RAL 3001 for the unshielded version Grey RAL 7032 for the shielded version

Length	Patch Cord CAT 5E U/UTP Grey	Patch Cord CAT 5E U/UTP Blue	Patch Cord CAT 5E U/UTP Red	Patch Cord CAT 5E F/UTP Grey
0,25 mt	2005026	-	-	-
0,5 mt	2005025	-	-	2005035
1 mt	2005021	2005027	2005045	2005031
2 mt	2005022	2005028	2005046	2005032
3 mt	2005023	2005029	2005047	2005033
5 mt	2005024	2005030	2005048	2005034

Patch cords and plugs

Category 6

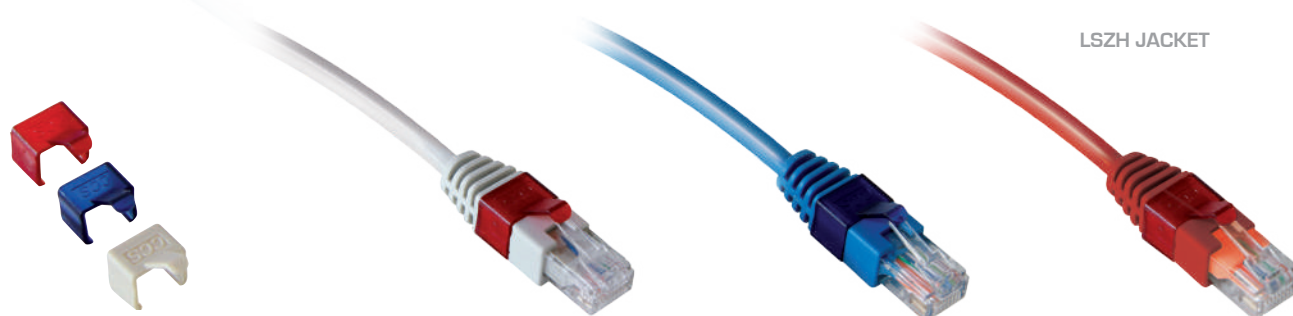

Patch cords

Description

CAT 6 CCS RJ45-RJ45 shielded or unshielded patch cord supplied with interchangeable coloured clips.
Outer jacket in LSZH flame retardant thermoplastic for the unshielded version and PVC for the shielded version.
Characteristics meet and exceed CAT 6 - Class E requirements up to 250 Mhz according to ANSI/TIA 568.2-D and ISO/IEC 11801.
Ideal for Gigabit Ethernet (IEEE 802.3ab) applications.

Performance

Compliance	CAT 6 – Class E
Approvals	ISO/IEC 11801-1/2:2017 EN 50173-1/2:2018 ANSI/TIA 568.2-D

General characteristics

Material	U/UTP or F/UTP cable shielded with AL/PET tape, 100 Ohm, 4 balanced pairs with AWG 24/7 (UTP version) or AWG26/7 (FTP version) bare copper flexibleconductors; LSZH outer jacket for unshielded versions and PVC for shielded versions; RJ45 plug with 8 nickel bronze contacts plated with 50 µm hard gold
Connection	Thermo-sealed protection cap; insulation displacement according to IEC 60352-4; T568B wiring diagram; grey, blue, red, interchangeable clips for easy application identification
Applications	Permanent connections between active transmission equipments and patch panels; interconnections between panels
Packaging	Every patch cord is individually packed
Colour	White RAL9018, Blue RAL5015, Red RAL3001 for the unshielded versions White RAL9018 for the shielded version

Length	Cat. 6 U/UTP White	Cat. 6 U/UTP Blue	Cat. 6 U/UTP Red	Cat. 6 F/UTP White PVC
1 mt	2005061	2005121	2005111	2005071
2 mt	2005062	2005122	2005112	2005072
3 mt	2005063	2005123	2005113	2005073
5 mt	2005066	2005124	2005114	2005076
7 mt	2005067	-	-	-
10 mt	2005068	-	-	-
15 mt	2005069	-	-	-

Patch cords and plugs

Category 6_A

LSZH JACKET



Patch cords

Description

CAT 6_A CCS RJ45-RJ45 shielded or unshielded patch cords with LSZH jacket. Certified by independent testing laboratories in accordance with Class E_A (Category 6_A) requirements on the channel link at 500 Mhz according to ANSI/TIA 568.2-D and ISO/IEC 11801 standards.

Ideal for 10 Gigabit Ethernet (IEEE 802.3an) applications.

Performance

Compliance Force Technology
Channel Class E_A

Approvals ISO/IEC 11801-1/2:2017
EN 50173-1/2:2018
ANSI/TIA 568.2-D
IEC 60512-99-002:2019

General characteristics

Material	S/FTP cable with pair and overall shield, 100 Ohm 4 balanced pairs with AWG26/7 bare copper flexible conductors; flame retardant LSZH outer jacket; RJ45 plugs with 8 nickel bronze contacts plated with 50 µm hard gold
Connection	Insulation displacement according to IEC 60352-4; T568B wiring diagram
Applications	Permanent connections between active transmission equipments and patch panels; interconnections between panels
Packaging	Every patch cord is individually packed
Colour	White cable RAL 9018 Blue cap RAL 5015

Length	Patch Cord CAT 6A U/UTP White	Patch Cord CAT 6A S/FTP White
1 mt	2005081	2005091
2 mt	2005082	2005092
3 mt	2005083	2005093
5 mt	2005084	2005094

Patch cords and plugs

Plugs



Category 5E

Description

CCS shielded or unshielded 8-pole plug to create patch cords. Characteristics meet and exceed CAT 5E - Class D requirements according to ISO/IEC 11801 and ANSI/TIA-568.2-D.

Characteristics

Material	Flame retardant thermoplastic material, with metal shell only for the shielded version
Contacts	8 nickel bronze contacts plated with 50 µm hard gold
Installation	On cables with flexible conductors
Packaging	Box 50 pcs



Performance

Compliance	Category 5E
Approvals	ISO/IEC 11801-1/2:2017 EN 50173-1/2:2018 ANSI/TIA-568.2-D

Code	Description
2012001	Cat 5E unshielded 8-pole RJ45 plug-UTP
2012002	Cat 5E shielded 8-pole RJ45 plug-STP

Category 6

Description

CCS shielded or unshielded 8-pole plug with pre-insert used to create patch cords. Characteristics meet and exceed CAT 6 - Class E requirements according to ISO/IEC 11801 and ANSI/TIA-568.2-D.

Characteristics

Material	Flame retardant thermoplastic material, with metal shell only for the shielded version
Contacts	8 nickel bronze contacts plated with 50 µm hard gold
Installation	On cables with flexible conductors
Packaging	Box 50 pcs



Performance

Compliance	Category 6
Approvals	ISO/IEC 11801-1/2:2017 EN 50173-1/2:2018 ANSI/TIA-568.2-D

Code	Description
2012005	Cat 6 unshielded 8-pole RJ45 plug-UTP
2012006	Cat 6 shielded 8-pole RJ45 plug-STP

Patch cords and plugs

Accessories



Boots for RJ45 plugs

Description

Coloured boots used to protect the plugs termination against the flexion and useful for the identification of the patch cord type. Available in different colours for a fast and easy identification of the cables.

Characteristics

Material	High flex thermoplastic material
Diameter	6,5 mm
Color	Blue, yellow, red, grey
Packaging	100 pcs

Code	Description
2012011	Boot for plug - Grey
2012012	Boot for plug - Blue
2012013	Boot for plug - Red
2012014	Boot for plug - Yellow



Crimping tools

Description

8-position crimping tools for RJ45 plug suitable for Cat.5E and Cat.6 RJ45 plugs to be installed on flexible cables.

Characteristics

Material	Burnished steel body, ergonomic handles made of thermoplastic material
Application	RJ45 plug crimping
Mechanism	Spring pressure system
Colour	Body: black Handles: red or black according to the model

Code	Description
2040086	8-position crimping tool for RJ45 plug
2040153	8-position professional crimping tool for RJ45 plug



Work outlet

All jacks of the CCS® cabling system are compatible with the Keystone standard to guarantee the integration in the vast majority of boxes and conduits produced by different manufacturers.

The range offered in the catalogue includes adapters for the most common civil series, 503 standard self-supporting faceplates, German, French and British type faceplates and 1 or 2-port wall mount boxes.

Faceplates and modules	p. 70
Multimedia box and Accessories	p. 74
Adapters	p. 75
Isolator	p. 76

Work outlet

Faceplates and modules

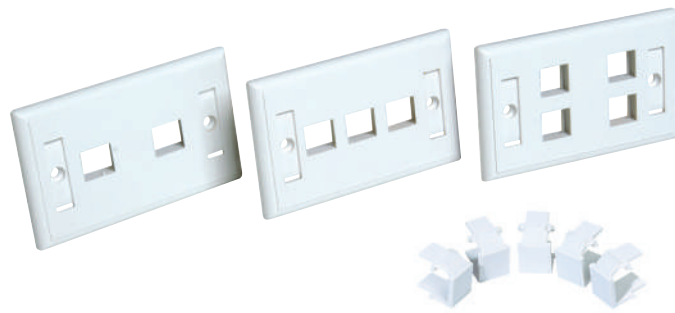

503 type faceplates

Description

2, 3, 4-port 503 type self supporting faceplates compatible with Keystone standard for CAT 5E, 6, 6A CCS shielded and unshielded jacks.

Available blind inserts for faceplates.

General characteristics

Structure	Flame retardant thermoplastic material with high mechanical resistance; identification label with clear plastic holder
Connection	Compatible with 503 type Keystone standard
Installation	On recessed box or wall
Colour	White
Accessories	Blind insert in FR thermoplastic material colour white
Compatibility	With the 3-port faceplate use only the Easy Crimp Compact jacks

Code	Description	Packaging
2004012	Self supporting 503 type 2-position faceplate	1 pc
2004013	Self supporting 503 type 3-position faceplate	1 pc
2004014	Self supporting 503 type 4-position faceplate	1 pc
2003005	Blind insert	1 pc

Work outlet

Faceplates and modules



Wall mount boxes

Description

1 and 2-port wall mount boxes for CCS keystone standard jacks with label-holder windows

General characteristics

Structure	Thermoplastic material
Slot	1 or 2 blank ports for CCS keystone standard jacks
Installation	Wall mount
Colour	White

Code	Description	Packaging
2004043	1-port blank wall mount box	1 pc
2004044	2-port blank wall mount box	1 pc

Work outlet

Faceplates and modules



German type faceplate

Characteristics

- Thermoplastic material, white colour
- 1 or 2-position blank module for CCS Easy Crimp jacks
- 80x80 mm frame
- Label-holder window
- Installation on recessed box

Code	Description
2004155	1-port CCS German type self-supporting faceplate 80x80mm
2004062	2-port CCS German type self-supporting faceplate 80x80mm

French type angled module 45x45 mm

Characteristics

- Thermoplastic material, white colour
- 1 or 2-position angled module for CCS jacks compatible with Keystone standard, 45x45 mm
- Label-holder window
- Installation on built-in box or wall

Code	Description
2004157	1-angled port CCS French type module 45x45mm
2004156	2-angled port CCS French type module 45x45mm



French type blank module 45x45 mm

Characteristics

- Thermoplastic material, white colour
- 1-position blank module for CCS jacks compatible with Keystone standard, 45x45 mm with sash window
- Label-holder window
- Installation on recessed box

Code	Description
2004059	CCS French type blank module with sash window 45x45mm

French type faceplate

Characteristics

- Thermoplastic material, white colour
- Faceplate with 2-position blank module for CCS jacks compatible with Keystone standard, 45x45 mm with sash window
- Label-holder window
- Installation on recessed box

Code	Description
2004042	2-port CCS French type self-supp-faceplate 45x45mm with module

Work outlet

Faceplates and modules



British type faceplates

Description

1 and 2-port CCS self supporting bevelled faceplates for angle or standard British type modules.

General characteristics

Structure	UV-stabilized ABS material with high mechanical resistance; bevelled.
Dimensions	1 port. 50x50 mm 2 port. 50x100 mm
Distance betw. screws	1 port 60 mm 2 port 121,60 mm
Installation	On recessed box or wall
Colour	white
Accessories	½ blank module ½ angle keystone adapter

Code	Description
2004151	1-port CCS British type bevelled faceplate 50x50mm
2004153	1/2 blank module for CCS British type faceplates
2004152	2-port CCS British type bevelled faceplate 50x100mm
2004154	1/2 angle keystone adapter for CCS UTP/STP jacks

Modules for British type faceplates

Description

CCS CAT5E and CAT6 unshielded jacks with IDC 110/KRONE termination system for transmission channels of Class D (CAT5E) and Class E (CAT6). Suitable for the installation on CCS British type faceplates.

General characteristics

Structure	UV-stabilized ABS and polycarbonate material with high mechanical resistance; RJ45 jack contacts in phosphor bronze plated with 50µm hard gold.
Connections	IDC 110/KRONE termination system
Installation	On British type faceplates
Colour	white

Code	Description
2002019	CCS Cat6 RJ45 UTP jack-110 IDC- for British faceplates
2002014	CCS Cat5E RJ45 UTP jack-110 IDC- for British faceplates

Work outlet

Multimedia box and Accessories

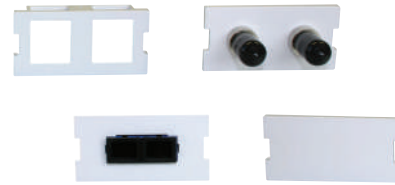

Multimedia box

Description

Wall mount multimedia box that can contain up to 3 modules (to be ordered separately) for the copper and fiber optic link connections.

General characteristics

Structure	Flame retardand thermoplastic material with high mechanical resistance; label holder window for jacks identification, coloured icons
Dimensions	W180xD150xH35 mm
Installation	Wall mount
Colour	White

Code	Description
2004070	Wall mount multimedia box

Modules for multimedia box

Description

Modules for multimedia box. They are available in different versions for the connection to both copper and fiber systems.

General characteristics

Structure	Thermoplastic with high mechanical resistance
Types	2-position module for Keystone jacks 2 ST MM adapters 1 SC Duplex MM adapter 1 blind module
Installation	On multimedia boxes
Colour	White

Code	Description
2004074	2-port blank module, Keystone standard
2004071	Module with 2 ST-ST adapters
2004072	Module with 1 SC-Duplex adapter
2004073	Blind module for multimedia box

Adapters



Civil series adapters for RJ45 jacks

Description

Adapter for the installation of CCS® RJ45 jacks on civil series frames.

Adapters for BTicino frames

Code	Description
2004026	Adapter - Magic series
2004027	Adapter - Living series
2004028	Adapter - Living International series
2004029	Adapter - Living Light series
2004034	Adapter - Living Light Tech series
2004036	Adapter - Magic TT series (Ivory)
2004037	Adapter - Matix series (White)
2004057	Adapter - Axolute series (Anthracite)
2004058	Adapter - Axolute series (Metal grey)
2004081	Adapter - Axolute series (White)
2004082	Adapter - Luna series (White)
2004103	Adapter - Now series (Black)
2004104	Adapter - Now series (Sand)
2004105	Adapter - Now series (White)

Adapters for Gewiss frames

Code	Description
2004032	Adapter - Playbus series
2004033	Adapter - System series (White)
2004038	Adapter - System series (Anthracite)
2004077	Adapter - Chorus series (Black)
2004078	Adapter - Chorus series (Titanium)
2004079	Adapter - Chorus series (White)

Adapters for Legrand frames

Code	Description
2004097	Adapter - Vela series (Black)
2004098	Adapter - Vela series (White)

Adapters for Vimar frames

Code	Description
2004030	Adapter - Idea series (Anthracite)
2004031	Adapter - Idea series (White)
2004035	Adapter - Plana series (White)
2004080	Adapter - Plana series (Silver)
2004075	Adapter - Eikon series (Anthracite)
2004076	Adapter - Eikon series (Metal grey)
2004092	Adapter - Eikon series (White)
2004064	Adapter - Arkè series (White)
2004063	Adapter - Arkè series (Black)
2004102	Adapter - Arkè series (Metal)

Adapters for ABB frames

Code	Description
2004099	Adapter - Elos series (Black)
2004093	Adapter - Chiara series (White)
2004084	Adapter - Mylos series (White)
2004100	Adapter - Mylos series (Black)

Work outlet

Isolator



Network isolator

Description

A network isolator is a device that can ensure electrical separation in LAN networks: it disconnects all electrically conductive connections between network peripherals and the connected device by providing protection against voltages up to 4 kV and higher. At the same time, it makes it possible to transmit data signals with extremely low losses in accordance with Cat. 6A/Class EA performance.

This type of isolators are used especially in the medical sector to reduce the risk of potential electrical injury to operators or patients and limit the extent of lightning damage. An adapter for DIN rail installation is provided as accessory.

Performances

Standards	ISO/IEC 11801 IEC 60601-1-2 IEC 60100-3-2/3 ANSI/AAMI ES60601-1 EN 60529
-----------	--

Characteristics

Structure	Plastic outer frame
Input interface	1 RJ45 port
Output interface	1 RJ45 port
Performance	For shielded Class EA/Cat. 6A transmission channels
Dielectric strength	6kV in AC; 8,5kV in DC
Working voltage	3000 VAC
Insulation section	2 MOPP
Temperature range	Da -10° C a +70° C
Protection rating	IP40

Code	Description	Packaging
2004004	Network isolator	1 pc

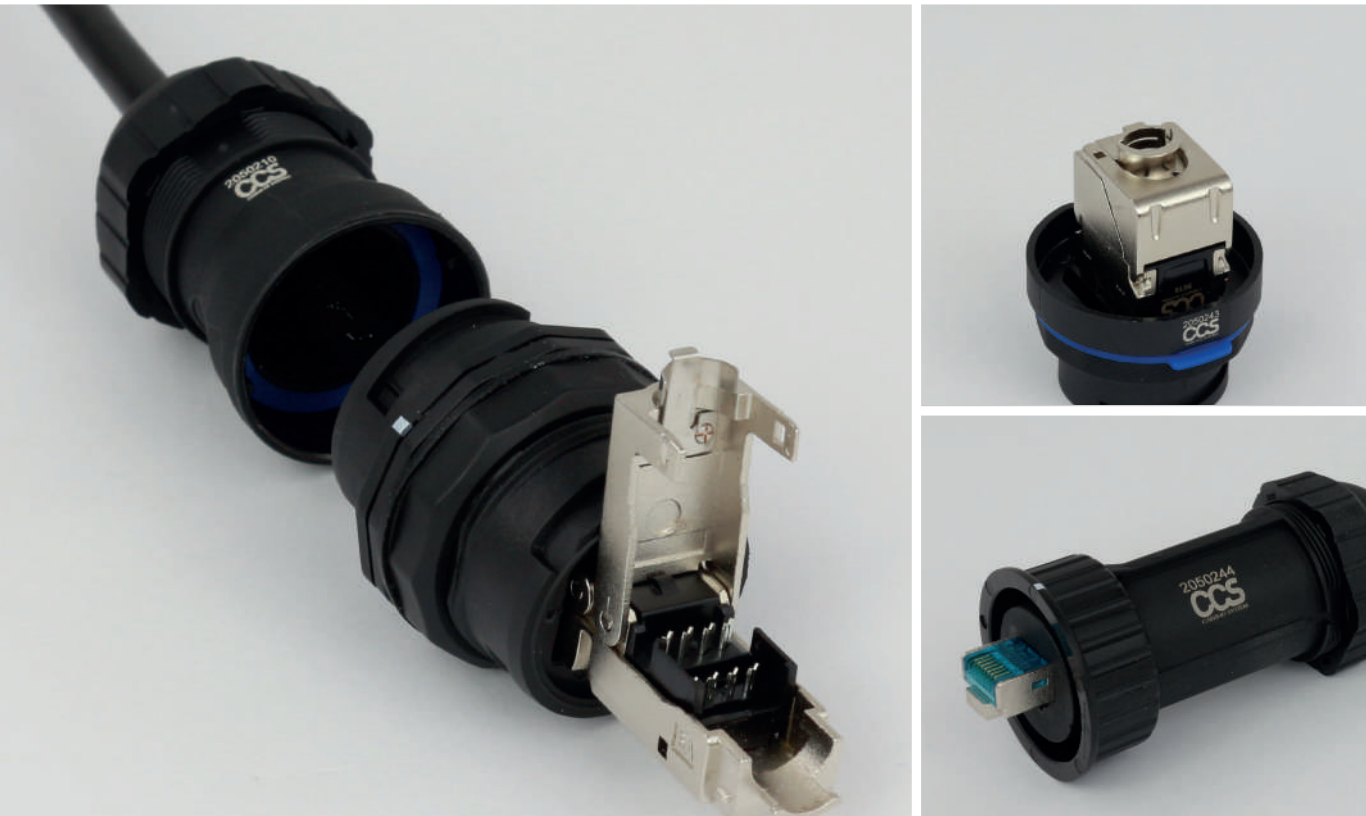

Industrial System

The use of Ethernet system in industrial environments asks for the use of specific cabling components, especially designed for use in demanding environments: industrial, chemical, food and military industries. CCS® offers a brand-new system of connection, termination and coupling in harsh conditions.

IP68 housing for RJ45 plugs	p. 78
IP68 housing for RJ45 jacks	p. 79
Receptacle	p. 80
IP68 inline coupler	p. 81
Field plugs	p. 82
DIN-rail adapters	p. 85

Industrial System

IP68 housing for RJ45 plugs



IP68 housing for RJ45 plugs

Description

IP68 housing to terminate LAN cables with RJ45 Easy Crimp plugs in demanding environments.
It can be used in association with the IP68 receptacle P/N 2050243 or with the IP68 housing protection for RJ45 Easy Crimp Compact STP jacks P/N 2050211.

Characteristics

Material	Housing, cable gland and cover in PA66; sealings in silicone rubber
Protection degree	IP68
Colour	Black
Compatibility	RJ45 Easy Crimp plugs cat 6 and Cat 6 _A STP and UTP

Compatibility



P/N. 2012008 Plug EASY CRIMP Cat. 6 STP
P/N. 2012009 Plug EASY CRIMP Cat. 6_A STP



P/N 2012007 Plug EASY CRIMP Cat. 6 UTP

Connection schemes



P/N 2050244

P/N 2050211



P/N 2050244

P/N 2050243

Code	Description	Packaging
2050244	IP68 housing for RJ45 Easy Crimp plugs	1 pc



IP68 housing for RJ45 jacks

Description

IP68 industrial housing to terminate LAN cables with RJ45 Easy Crimp Compact jacks STP in demanding environments. It can be used together with IP68 housing for RJ45 Easy Crimp plugs P/N 2050244

Characteristics

Material	Housing, cable gland and cover in PA66; sealings in silicone rubber
Protection degree	IP68
Colour	Black
Compatibility	RJ45 Easy Crimp Compact STP shielded jacks

Compatibility



P/N 2001028 EASY CRIMP COMPACT cat. 6A Channel STP RJ45 jack



P/N 2001029 EASY CRIMP COMPACT cat. 6_A STP RJ45 jack

Connection schemes



P/N 2050211

P/N 2050244

Code	Description	Packaging
2050211	IP68 housing for RJ45 Easy Crimp Compact STP jacks	1 pc



IP68 receptacle

Description

CCS IP68 receptacle suitable for the installation of RJ45 Easy Crimp Compact jacks and CCS optical adapters keystone type. It can be used together with IP68 housing for plugs P/N 2050244.

Characteristics

Material	Housing in PTB, ring nut in PA66, sealings in silicone rubber
Protection degree	IP68
Colour	Black
Compatibility	RJ45 Easy Crimp Compact shielded and unshielded jacks or CCS optical adapters keystone type

Compatibility

Full compatibility with all RJ45 jacks Easy Crimp Compact series

Connection schemes



COD. 2050243

COD. 2050244

Code	Description	Packaging
2050243	IP68 receptacle for RJ45 Easy Crimp Compact jacks	1 pc



IP68 Cat. 6A STP in-line coupler

Description

CCS Easy Crimp IP68 in-line coupler Category 6A STP ideal to extend existing copper links in environments demanding for high protection degree.

Toolless termination system for an easy and quick termination. It complies with Cat 6A Class EA requirements, standards ISO/IEC 11801, EN 50173 and ANSI/TIA 568.2-D.

Performances

Compliance	Category 6A - Class EA
Standards	ISO/IEC 11801-1/2: 2017 EN 50173-1/2: 2018 ANSI/TIA-568.2-D IEC 60529

Characteristics

Material	IP68 base PA + GF; cable glands PA66; coupler in zinc-alloy nickel plated; wire manager in PC-FR UL94 V0; IDC terminals in phosphor bronze tin plated
Connection	IDC insulation displacement for solid copper conductors 22-26 AWG; double label indicating T568A/B connection scheme
Installation	On solid cables
Retermination	5 times
Protection degree	IP68
Colour	Housing: black Coupler: metal grey
Cable OD	From 6 to 9 mm

Code	Description	Packaging
2050210	IP68 in-line coupler Easy Crimp cat. 6A STP shielded	1 pc



Easy Crimp CAT 6 STP

Description

CCS Easy Crimp shielded plug used to connect cables with solid and flexible conductors.

With the toolless Easy Crimp system, the connection is always fast and performing.

Ideal for the realization of modular plug terminated link (MPTL), "transition point" or patch cords out of the standard lengths.

Characteristics meet and exceed Cat.6 - Class E requirements according to ISO/IEC 11801 and ANSI/TIA 568.2-D.

Suitable for PoE/PoE+/PoE++ applications..

General characteristics

Material	Plug housing in zinc alloy with high mechanical resistance; 8 nickel bronze contacts plated with 50 µm hard gold
Connection	IDC insulation displacement for solid conductors 22-26 AWG and flexible conductors 22-27 AWG; double labelling colour scheme indicating the two T568A/B connections
Installation	On cables with solid and flexible conductors
Compatible cable diameter	From 6 to 9 mm

Performance

Compliance	UL 1863 Communications-Circuit Accessories
Standards	ISO/IEC 11801-1/2:2017 EN 50173-1/2:2018; ANSI/TIA-568.2-D IEC 60603-7-5 IEC 60512-99-002:2019

Code	Description	Packaging
2012008	CAT6 STP Easy Crimp field plug	1 pc.

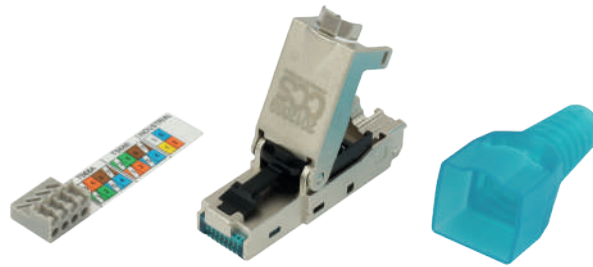

Easy Crimp CAT 6_A STP

Description

CCS Easy Crimp shielded plug used to connect cables with solid and flexible conductors.

With the toolless Easy Crimp system, the connection is always fast and performing.

Suitable for the realization of the modular plug terminated link (MPTL), "transition point" or patch cords out of the standard lengths.

Characteristics meet and exceed Cat.6_A - Class E_A requirements according to ISO/IEC 11801 and ANSI/TIA-568.2-D

Suitable for PoE/PoE+/PoE++ applications

General characteristics

Material	Plug housing in zinc alloy with high mechanical resistance; 8 nickel bronze contacts plated with 50 µm hard gold
Connection	IDC insulation displacement for solid conductors 22-26 AWG and flexible conductors 22-27 AWG; double labelling colour scheme indicating the two T568A/B connections
Installation	On cables with solid and flexible conductors
Compatible cable diameter	From 6 to 9 mm

Performance

Compliance	UL 1863 Communications-Circuit Accessories
Standards	ISO/IEC 11801-1/2:2017 EN 50173-1/2:2018; ANSI/TIA-568.2-D IEC 60603-7-51 IEC 60512-99-002:2019

Code	Description	Packaging
2012009	CAT6A STP Easy Crimp field plug	1 pc



Easy Crimp Compact CAT 6_A STP

Description

CCS Easy Crimp Compact Cat. 6_A shielded RJ45 field plug used to terminate cables with solid or stranded conductors. Toolless plugs, no tool is needed for a quick and easy termination. Ideal for the realization of MPTL connections (Modular Plug Terminated Link) or patch cords of non-standard length. Characteristics meet and exceed Cat.6_A - Class E_A requirements according to ISO/IEC 11801 and ANSI/TIA-568.2-D Suitable for PoE/PoE+/PoE++ applications.

Characteristics

Material	Plug body in zinc alloy nickel plated, wire manager in flame retardant polycarbonate UL94 V0; 8 contacts phosphor bronze alloy plated with 50µm of gold; steel cable gland
Connection	IDC insulation displacement for solid conductors 22-26 AWG and stranded 23-27 AWG; label indicating T568A/B connection schemes
Installation	On cables with solid and stranded conductors
Cable OD	From 6 to 9 mm

Performance

Compliance	UL 1863 Communications-Circuit Accessories
Standards	ISO/IEC 11801-1/2:2017 EN 50173-1/2:2018; ANSI/TIA-568.2-D IEC 60603-7-51 IEC 60512-99-002:2019

Code	Description	Packaging
2012026	CAT 6A STP Easy Crimp Compact field plug	1 pc.

DIN-rail adapters

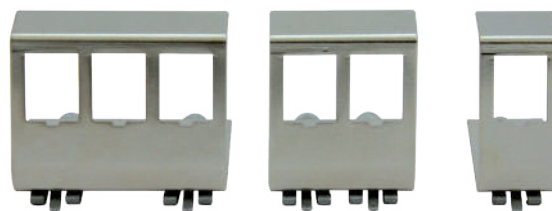
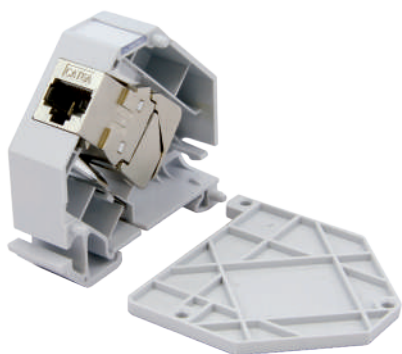

DIN-Rail plastic adapter

Description

DIN-rail plastic adapter for 1 shielded or unshielded CCS keystone jack. Supplied with side-cover to grant high degree protection rating.

General characteristics

Structure	Plastic body, side-by-side mountable, with spring for grounding and side cover
Connection	Compatible with RJ45 keystone jacks
Installation	On 35 mm DIN-Rail according to DIN EN60715
Colour	Grey
Ports	1

DIN-Rail metal adapters

Description

DIN-rail metal adapter for 1, 2 or 3 CCS Keystone shielded and unshielded RJ45 jacks

General characteristics

Structure	Metal body
Connection	Compatible with RJ45 keystone shielded and unshielded jacks
Installation	On 35mm DIN-Rail according to DIN EN60715
Colour	Metal
Ports	1, 2 and 3-port

Code	Description
2050246	CCS DIN-Rail 1-port plastic adapter

Code	Description
2050247	CCS DIN-Rail 1-port metal adapter
2050248	CCS DIN-Rail 2-port metal adapter
2050249	CCS DIN-Rail 3-port metal adapter

Fiber optic cabling system



Used for the realization of long and short distance connections, the components of optical cabling system allow to realize high speed transmission channels while providing at the same time minimum space take up and maximum immunity to electromagnetic interferences.

CCS® offers a complete range of products including optical cables, connectors, trays, termination kits or solutions ready for installation (pre-terminated optical cables).

<i>FO cables</i>	<i>p. 87</i>
<i>Pre-terminated FO cables</i>	<i>p. 93</i>
<i>FO cabling system</i>	<i>p. 97</i>
<i>Fiber optic termination</i>	<i>p. 117</i>
<i>Fiber To The Home</i>	<i>p. 123</i>

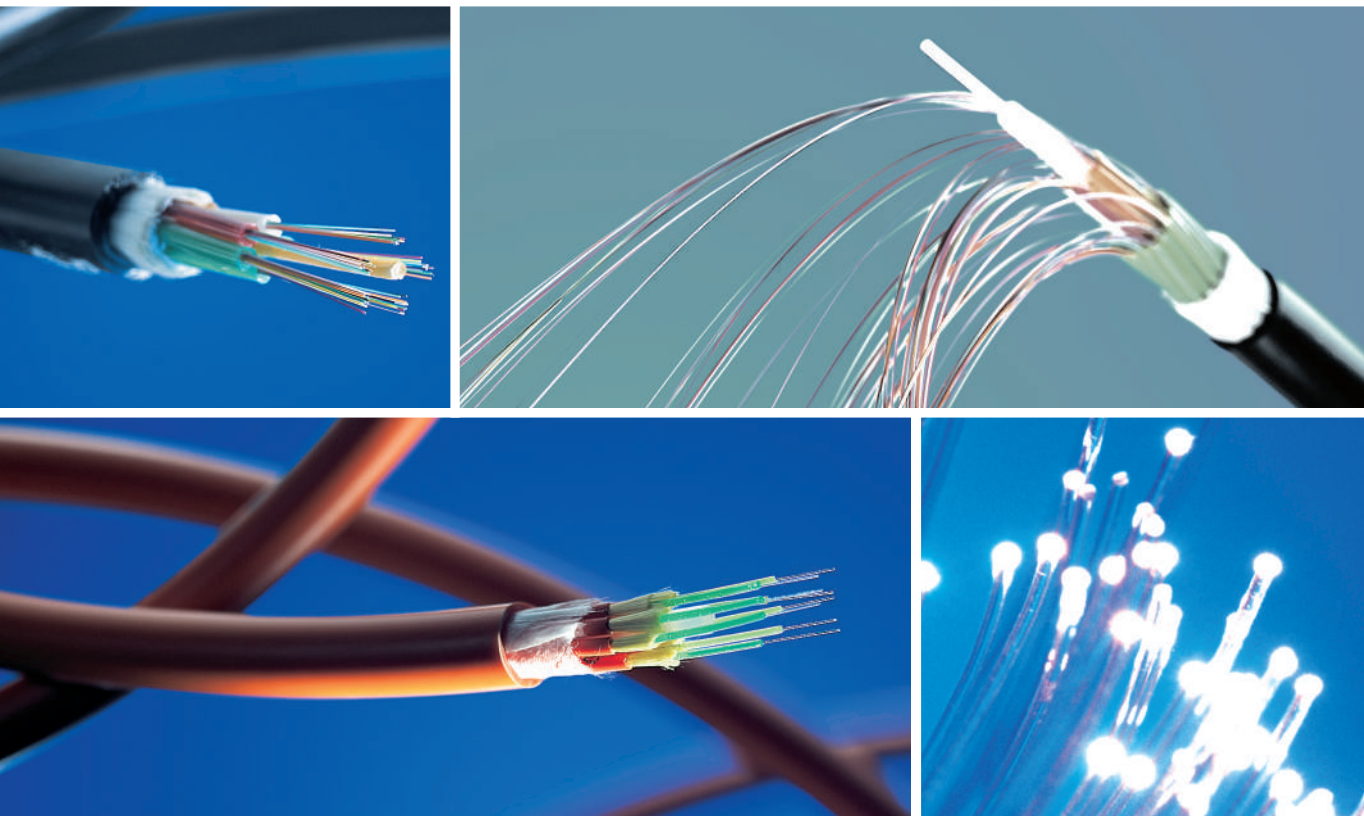

FO cables

The main component for optical cabling systems is the cable. In order to choose the right cable, it is fundamental to consider the constructive characteristics, the type of fiber used, the distance to be covered, the requested application and the type of laying.

In this section you will find a wide selection of products depending on the environment of installation (indoor, indoor/outdoor, outdoor), on the type of armouring (with metallic armour and/or with dielectric anti-rodent armour) and on their reaction to fire.

Introduction	p. 88
Indoor/outdoor cables	p. 89
Outdoor cables	p. 91

FO cables

Dimensional and transmission characteristics of optical fibers



Geometrical and mechanical properties

Characteristics	Fiber G50/125	Fiber G62.5/125	Fiber E9/125
Core diameter (µm)	50 ± 2.5	62.5 ± 2.5	9.2 ± 0.4
Cladding diameter (µm)	125 ± 1	125 ± 1	125 ± 0.7
Primary coating (µm)	245 ± 5	245 ± 5	245 ± 5
Core non-circularity (%)	< 5	< 5	-
Cladding non-circularity (%)	< 0.7	< 0.7	< 0.7
Core/Cladding concentricity error (µm)	< 1	< 1	< 0.5
Primary coating concentricity error (µm)	< 10	< 10	< 12

Transmission properties of Multimode fibers

Characteristics	50/125 OM2		50/125 OM3		50/125 OM4		62,5/125 OM1	
	850	1300	850	1300	850	1300	850	1300
Wavelength (nm)	850	1300	850	1300	850	1300	850	1300
Attenuation max. (dB/Km)	3.0	1.0	3.5	1.5	3.5	1.5	3.5	1.5
Bandwidth min. (MHz·Km)	500	500	1500	500	3500	500	≥ 220	≥ 500
Effective group index	1.483	1.478	1.482	1.477	1.482	1.477	1.496	1.491
Numerical aperture	0.200 ± 0.020		0.200 ± 0.015		0.200 ± 0.015		0.275 ± 0.015	
Gigabit link max length (mt)	550	550	1000	550	1100	550	275	550
10 Gigabit link max length (mt)	-	-	300	300	550	300	-	-

Transmission properties of Single-mode fibers

Characteristics	9/125 G.652.D	
Wavelength (nm)	1310	1550
Attenuation max. (dB/Km)	0.35	0.24
Chromatic dispersion (ps/nm·Km)	-	≤ 18
Zero-dispersion wavelength (nm)	1304 - 1324	
Cutoff wavelength (nm)	≤ 1250	
Effective group index	1.4676	1,4682
10 Gigabit link max length (mt)	10000	40000

FO Colour chart according to IEC 60304 norms

1 Red	7 Brown	13 Red/black	19 Brown/black
2 Green	8 Violet	14 Green/black	20 Violet/black
3 Blue	9 Turquoise	15 Blue/black	21 Turquoise/black
4 Yellow	10 Black	16 Yellow/black	22 Transparent/black
5 White	11 Orange	17 White/black	23 Orange/black
6 Grey	12 Pink	18 Grey/black	24 Pink/black

Legend of cable characteristics symbols





The colour of the jacket in the picture is purely informational

U-DQ(BN)H / I-B(ZN)BH Loose monotube LSZH jacket

Loose fiber optic cables with LSZH (Low Smoke Zero Halogen) outer jacket, 250µm primary coating of the fiber, dielectric anti-rodent protection. In the U-DQ-(BN)H version fibers are kept together inside a single thermoplastic tube and filled with a water-blocking gel to prevent moisture penetration while version I-B(ZN)BH is dry core type with loose tube without gel.





Applications and performance

Cables U-DQ-(BN)H type are suitable for indoor and outdoor use, while cables I-B(ZN)BH, in Euroclass B2ca, are suitable only for indoor installation according to EN 50173, ISO/IEC 11801. Depending on the type of fiber and on the length of the link, they are suitable for the realization of transmission channels up to and exceeding 10GbE. Ideal for laying in dry pipes or ducts for the realization of backbones connecting cabinets of the same building or located in different buildings.

Certifications and approvals

Data transmission FO cables according to IEC 60793 and IEC 60794-1-2.

Outer Jacket colour chart

	Multimode fiber 50/125 OM2
	Multimode fiber 50/125 OM3
	Multimode fiber 50/125 OM4
	Multimode fiber 62,5/125 OM1
	Single-mode fiber 9/125

IEC 60794-1-2
IEC 60793



Construction characteristics

Cable core	Cables U-DQ(BN)H gel filled loose tube Cables I-B(ZN)BH gel free loose tube
Filler protection	Glass yarns
Outer jacket material	LSZH/ see colour chart
Armour	Dielectric
Loose tube diameter	From 2,5 to 3 mm
Outer diameter	From 5,4 to 7 mm
Weight	From 35 to 70 kg/km

Mechanical and environmental properties

Use	Indoor and outdoor
Bend. radius during installation	20 x outer diameter
Bend. radius after installation	15 x outer diameter
Max.pulling strength	Starting from 1000 N
Crush test	Starting from 1500 N/dm
Installation temperature	From -5°C to +50°C
Operating temperature	From -20°C to +60°C

Fire behaviour

CPR Regulation	EN 50575
Fire behaviour	EN 50399 (only for Euroclass Cca and B2ca EN 60332-1 EN 60754-1/2 EN 61034-2
Acid gas emission	EN 60754-1/2
Smoke density	EN 61034-2

Euroclass	Type	No. Fibers	9/125 OS2	50/125 OM2	50/125 OM3	50/125 OM4	62,5/125 OM1
Eca	U-DQ(BN)H	4 fibers	2008100	2008081	2008081OM3	2008081OM4	2008051
		8 fibers	2008107	2008083	2008083OM3	2008083OM4	2008052
		12 fibers	2008105	2008084	2008084OM3	2008084OM4	2008053
		24 fibers	2008108	2008086	2008086OM3	2008086OM4	2008056
Cca s1a, d1, a1	U-DQ(BN)H	4 fibers	2008411	-	2008416OM3	2008416OM4	-
		8 fibers	2008412	-	2008417OM3	2008417OM4	-
		12 fibers	2008413	-	2008418OM3	2008418OM4	-
		24 fibers	2008414	-	2008419OM3	2008419OM4	-
B2ca s1a, d0, a1	I-B(ZN)BH	6 fibers	2008432	-	2008436OM3	2008436OM4	-
		12 fibers	2008434	-	2008438OM3	2008438OM4	-
		24 fibers	2008435	-	2008439OM3	2008439OM4	-

FO cables

Indoor/outdoor use



The colour of the jacket in the picture is purely informational

U-DQ(BN)(SR)H Loose Monotube - metallic armour - LSZH jacket

IEC 60794-1-2
IEC 60793



Loose fiber optic cable with corrugated steel tube metallic armour, LSZH (Low Smoke Zero Halogen) outer jacket, 250µm fiber primary coating, longitudinal and transverse water-penetration resistant. The corrugated steel tube armour offers a high mechanical protection against rodents and compressive stresses. Optical fibers are kept together inside a thermoplastic tube and filled with water-blocking gel to prevent moisture penetration.

Application and performance

Cable suitable for the realization of cabling systems for indoor and outdoor use according to EN 50173, ISO / IEC 11801 norms. Depending on the type of fiber and on the length of the link, they are suitable for the realization of transmission channels up to and exceeding 10GbE. Ideal for laying in pipes or ducts for the realization of backbones connecting cabinets of the same building or located in different buildings.

Certifications and approvals

Data transmission FO cables according to IEC 60793 and IEC 60794-1-2.

Outer Jacket colour chart

- Multimode fiber 50/125 OM2
- Multimode fiber 50/125 OM3
- Multimode fiber 50/125 OM4
- Multimode fiber 62,5/125 OM1
- Single-mode fiber 9/125

Construction characteristics

Cable core	Fibers immersed in gel filled Loose tube
Protection filler	Water-blocking glass yarns
Material/outer jacket colour	LSZH/see colour chart
Armour	Corrugated steel tube
Outer diameter	From 7,9 to 10,5 mm
Weight	From 87 to 150 kg/km

Mechanical and environmental properties

Use	Indoor and outdoor
Bend.radius during installation	20 x outer diameter
Bend.radius after installation	15 x outer diameter
Max.pull strength	Starting from 1000 N
Crush test	Starting from 2000 N/dm
Installation temperature	From -15°C to +50°C
Operating temperature	From -20°C to +60°C

Fire behaviour

CPR Regulation	EN 50575
Fire behaviour	EN 50399 (only for Euroclass B2ca) EN 60332-1-2
Acid gas emission	EN 60754-1/2
Smoke density	EN 61034-2

Euroclass	No. Fibers	9/125 OS2	50/125 OM2	50/125 OM3	50/125 OM4	62,5/125 OM1
Eca	4 fibers	2008380	2008061	2008061OM3	2008061OM4	2008065
	8 fibers	2008381	2008062	2008062OM3	2008062OM4	2008066
	12 fibers	2008382	2008063	2008063OM3	2008063OM4	2008067
	24 fibers	2008383	2008064	2008064OM3	2008064OM4	2008068
B2ca s1a-d1-a1	12 fibers	2008423	-	2008428OM3	2008428OM4	-

FO cables

Outdoor use



The colour of the jacket in the picture is purely informational

A-DQ(BN)2Y Loose Monotube PE Jacket

IEC 60794-1-2
IEC 60793



Light and flexible non-metallic loose fiber optic cables with high mechanical resistance: dielectric armour, PE (Polyethylene) outer jacket, 250µm fiber primary coating, longitudinal water-penetration resistant and dielectric anti-rodent protection. Optical fibers are kept together inside a thermoplastic tube and filled with a water-blocking gel to prevent moisture penetration.

Application and performance

Cable suitable for the installation of cabling systems for outdoor use according to EN50173, ISO/IEC 11801 norms. Depending on the type of fiber and on the length of the link, they are suitable for the realization of transmission channels up to and exceeding 10GbE. Ideal for laying in pipes or ducts for the realization of outdoor backbones connecting different buildings.

Certifications and approvals

Data transmission FO cables according to IEC 60793 and IEC 60794-1-2.

Construction characteristics

Cable core	Fibers immersed in gel filled Loose tube
Protection filler	Water-blocking glass yarns
Material/outer jacket colour	PE/see colour chart
Armour	Dielectric
Loose tube diameter	From 2,5 to 3,5 mm
Outer diameter	From 5,4 to 7,2 mm
Weight	From 27 to 65 kg

Mechanical and environmental properties

Use	Outdoor
Bend.radius during installation	20 x outer diameter
Bend.radius after installation	15 x outer diameter
Max.pull strength	Starting from 1000 N
Crush test	Starting from 2000 N/dm
Installation temperature	From -5°C to +40°C
Operating temperature	From -20°C to +60°C

Outer Jacket colour chart

	Multimode fiber 50/125 OM2
	Multimode fiber 50/125 OM3
	Multimode fiber 50/125 OM4
	Multimode fiber 62,5/125 OM1
	Single-mode fiber 9/125

Euroclass	No. Fibers	9/125 OS2	50/125 OM2	50/125 OM3	50/125 OM4	62,5/125 OM1
Fca	4 fibers	2008302	2008306	2008306OM3	2008306OM4	2008309
	8 fibers	2008303	2008087	2008087OM3	2008087OM4	2008310
	12 fibers	2008304	2008307	2008307OM3	2008307OM4	2008311
	24 fibers	2008305	2008308	2008308OM3	2008308OM4	2008312

FO cables

Outdoor use



The colour of the jacket in the picture is purely informational

A-DQ(CBN)(SR)2Y Loose Monotube metallic armour PE jacket

IEC 60794-1-2
IEC 60793



Loose fiber optic cable, with corrugated steel tape metallic armour, PE (Polyethylene) outer jacket, 250µm fiber primary coating, longitudinal and transverse water-penetration resistant. The corrugated steel armour offers a high mechanical protection against rodents and compressive stresses. Optical fibers are kept together inside a thermoplastic tube filled with water-blocking gel to prevent moisture penetration.

Application and performance

Cable suitable for the realization of cabling systems for outdoor use according to EN 50173, ISO/IEC 11801 norms. Depending on the type of fiber and on the length of the link, they are suitable for the realization of transmission channels up to and exceeding 10GbE. Ideal for laying in pipes or ducts for the realization of outdoor backbones connecting buildings in locations where a good water and rodent resistance is needed.

Certifications and approvals

Data transmission FO cables according to IEC 60793 and IEC 60794-1-2.

Construction characteristics

Cable core	Fibers immersed in gel filled Loose tube
Protection filler	Water-blocking glass yarns
Material/outer jacket colour	PE/typically Blue
Armour	Corrugated steel tube
Outer diameter	From 7,7 to 9,6 mm
Weight	From 70 to 115 kg

Mechanical and environmental properties

Use	outdoor
Bend.radius during installation	20 x outer diameter
Bend.radius after installation	15 x outer diameter
Max.pull strength	Starting from 1000 N
Crush test	Starting from 2000 N/dm
Installation temperature	From -5°C to +50°C
Operating temperature	From -20°C to +70°C

Euroclass	No. Fibers	9/125 OS2	50/125 OM2	50/125 OM3	50/125 OM4	62,5/125 OM1
Fca	4 fibers	2008321	2008326	2008326OM3	2008326OM4	2008330
	8 fibers	2008323	2008088	2008088OM3	2008088OM4	2008332
	12 fibers	2008324	2008328	2008328OM3	2008328OM4	2008333
	24 fibers	2008325	2008329	2008329OM3	2008329OM4	2008334

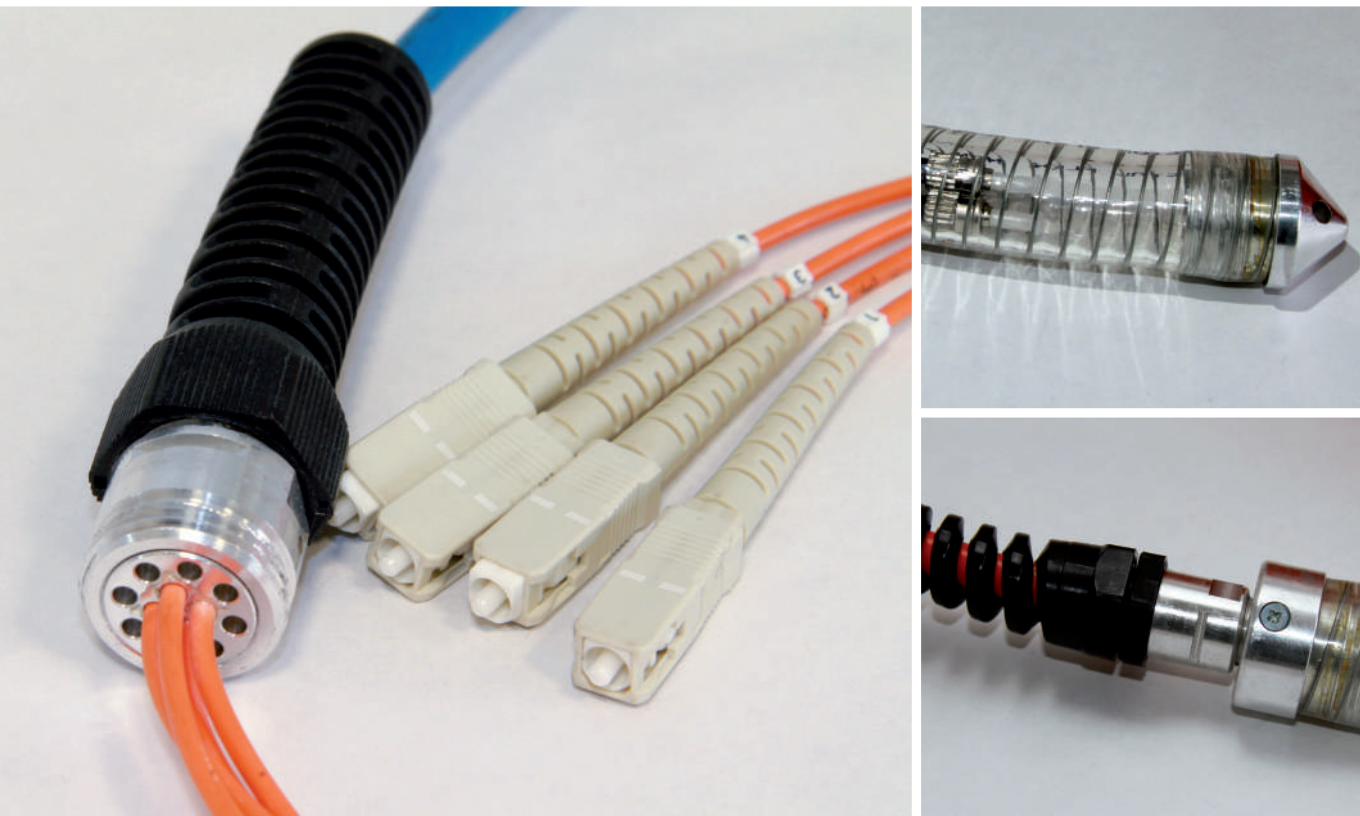

Pre-terminated FO cables

CCS® offers pre-terminated fiber optic cables tested and certified in laboratory in the required length. Available with dielectric or metallic armour, Single-Mode or Multimode, OM1 to OM4, the cables are terminated with ST, SC or LC connectors at both ends.

Pre-terminated FO cables	p. 94
Indoor/outdoor use	p. 95
Outdoor use	p. 96

Pre-terminated FO cables

Pre-terminated FO cables



How to order

1. Choose the cable to use among the available ones at pages 95 and 96
2. Specify in the order the required length by considering the spair quantity to store inside the rack plus one additional meter, at both ends of the cable, necessary for the termination
3. On the base of the number of fibers and cable type, choose the desired assembly and indicate in your order the corresponding code (1 pc for each length)

Description	No. Fibers	ST	SC	LC
Termination kit for indoor/outdoor LSZH loose cable	4	2008210	2008220	2008240
	6	2008212	2008222	2008241
	8	2008211	2008221	2008242
	12	2008213	2008223	2008243
	24	2008214	2008224	2008244
Termination kit for loose cable with metallic armour	6	2008216	2008226	2008246
	12	2008218	2008228	2008248
	24	2008219	2008229	2008249

Pre-terminated FO cable

Description

Pre-terminated fiber optic loose cable assemblies with LSZH outer jacket for indoor/outdoor use or with PE outer jacket and and metallic armour for outdoor use only. Assemblies with ST, SC, LC connectors are available; special connectors can be supplied upon request. The termination kit includes :

- Full fibers termination on both ends
- Optical connectors
- Splitter kit for the separation and protection of fibers
- Protection of the fastened-to-heads connectors with a special corrugated tube, reinforced with thermoplastic material, with 32 mm diameter and 70 cm long
- Test report and certification attached to the package

During installation we recommend to follow the instructions attached to the package. The cable duct must have a diameter of 50 mm at least.

Terminations protection kit

Description and guidelines

01. Release the two screws on the protection tube and then the splitter kit
02. Carefully pull out the protection tube while maintaining the protection kit downwards and avoid producing any torsion on the terminations
03. Protection system metal tip
04. Hole to fix the tow-system, max. pull strength 100N

Pre-terminated FO cables

Indoor/outdoor use

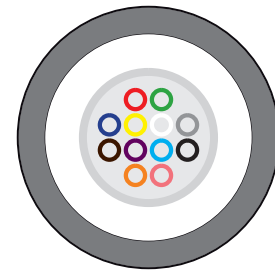
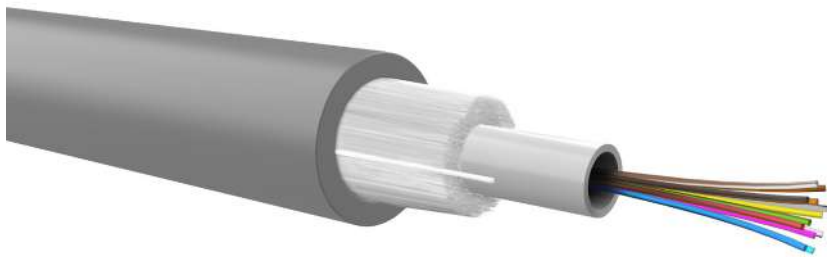

The colour of the jacket in the picture is purely informational

U-DQ(ZN)BH / I-B(ZN)BH Loose monotube LSZH jacket

Universal Loose cables to be pre-terminated, with LSZH (Low Smoke Zero Halogen) outer jacket, 250µm primary coating of the fiber, dielectric anti-rodent protection. In the U-DQ-(ZN)BH version fibers are kept together inside a single thermoplastic tube and filled with a water-blocking gel to prevent moisture penetration while version I-B(ZN)BH is dry core type with loose tube without gel.

Applications and performance

Cables U-DQ-(ZN)BH type, in Euroclass Dca, are suitable for indoor and outdoor use, while cables I-B(ZN)BH, in Euroclass B2ca, are suitable only for indoor installation according to EN 50173, ISO/IEC 11801. Depending on the type of fiber and on the length of the link, they are suitable for the realization of transmission channels up to and exceeding 10GbE. Ideal for laying in dry pipes or ducts for the realization of backbones connecting cabinets of the same building or located in different buildings.

Certifications and approvals

Data transmission FO cables according to IEC 60793 and IEC 60794-1-2.

Outer Jacket colour chart

	Multimode fiber 50/125 OM2
	Multimode fiber 50/125 OM3
	Multimode fiber 50/125 OM4
	Multimode fiber 62,5/125 OM1
	Single-mode fiber 9/125

IEC 60794-1-2
IEC 60793



Construction characteristics

Cable core	Cables U-DQ(ZN)BH gel filled loose tube Cables I-B(ZN)BH gel free loose tube
Filler protection	Anti rodent glass yarns
Outer jacket material	LSZH/ see colour chart
Armour	Dielectric
Loose tube diameter	From 2,5 to 3 mm
Outer diameter	From 5,8 to 7 mm
Weight	From 37 to 51 kg/km

Mechanical and environmental properties

Use	Indoor and outdoor
Bend. radius during installation	20 x outer diameter
Bend. radius after installation	15 x outer diameter
Max.pulling strength	Starting from 1250 N
Crush test	1500 N/dm
Installation temperature	From -5°C to +40°C
Operating temperature	From -20°C to +60°C

Fire behaviour

CPR Regulation	EN 50575
Fire behaviour	EN 50399
	EN 60332-1
Acid gas emission	EN 60754-1/2
Smoke density	EN 61034-2

Euroclass	Type	No. Fibers	9/125 OS2	50/125 OM2	50/125 OM3	50/125 OM4	62,5/125 OM1
Dca s2-d1-a1	U-DQ(ZN)BH	4 fibers	2008345	2008355	2008355OM3	-	2008365
		8 fibers	2008347	2008357	2008357OM3	-	2008367
		12 fibers	2008348	2008358	2008358OM3	2008358OM4	2008368
		24 fibers	2008349	2008359	2008359OM3	2008359OM4	2008369
B2ca s1a-d0-a1	I-B(ZN)BH	6 fibers	2008370	-	2008373OM3	2008373OM4	-
		12 fibers	2008371	-	2008374OM3	2008374OM4	-
		24 fibers	2008372	-	2008375OM3	2008375OM4	-

PRE-TERMINATED

Pre-terminated FO cables

Outdoor use



The colour of the jacket in the picture is purely informational

A-DQ(ZN)(SA)2Y Loose monotube with metallic armour and PE jacket

IEC 60794-1-2
IEC 60793

Outdoor Loose cable to be pre-terminated, with corrugated steel tape metallic armour, PE (polyethylene) outer jacket, 250 µm primary coating of the fiber, longitudinal and transverse water-penetration resistant. The corrugated steel tape offers a safer and more effective mechanical protection against rodents and compressive stresses. Optical fibers are kept together inside a thermoplastic tube filled with water-blocking gel to prevent moisture penetration.

Construction characteristics

Cable core	Loose tube with fibers immersed in water-blocking gel
Filler protection	Glass yarns
Outer jacket material	PE
Armour	Corrugated steel tape
Core diameter	From 2,8 to 3,5 mm
Outer diameter	8,5 mm
Weight	From 75 to 80 kg/km

Applications and performance

Cable suitable for the realization of cabling systems for outdoor use according to EN 50173, ISO/IEC 11801 norms. Depending on the type of fiber and on the length of the link, they are suitable for the realization of transmission channels up to and exceeding 10GbE. Ideal for laying in pipes or ducts for the realization of outdoor backbones connecting buildings in environments where a high water resistance is required.





Mechanical and environmental properties

Use	Outdoor
Bend. radius during installation	15 x outer diameter
Bend. radius after installation	10 x outer diameter
Max. pulling strength	1000 N
Crush test	2000 N/dm
Installation temperature	From -40°C to +70°C
Operating temperature	From -40°C to +70°C

Certifications and approvals

Data transmission FO cables according to IEC 60793 and IEC 60794-1-2.

Outer Jacket colour chart

	Multimode fiber 50/125 OM2
	Multimode fiber 50/125 OM3
	Multimode fiber 62,5/125 OM1
	Single-mode fiber 9/125

No. Fibers	9/125 OS2	50/125 OM2	50/125 OM3	62,5/125 OM1
6 fibers	2008341	2008350	-	2008360
12 fibers	2008340	2008351	2008351OM3	2008361
24 fibers	2008342	2008352	-	-

Fiber optic cabling system – Fiber optic cabling system

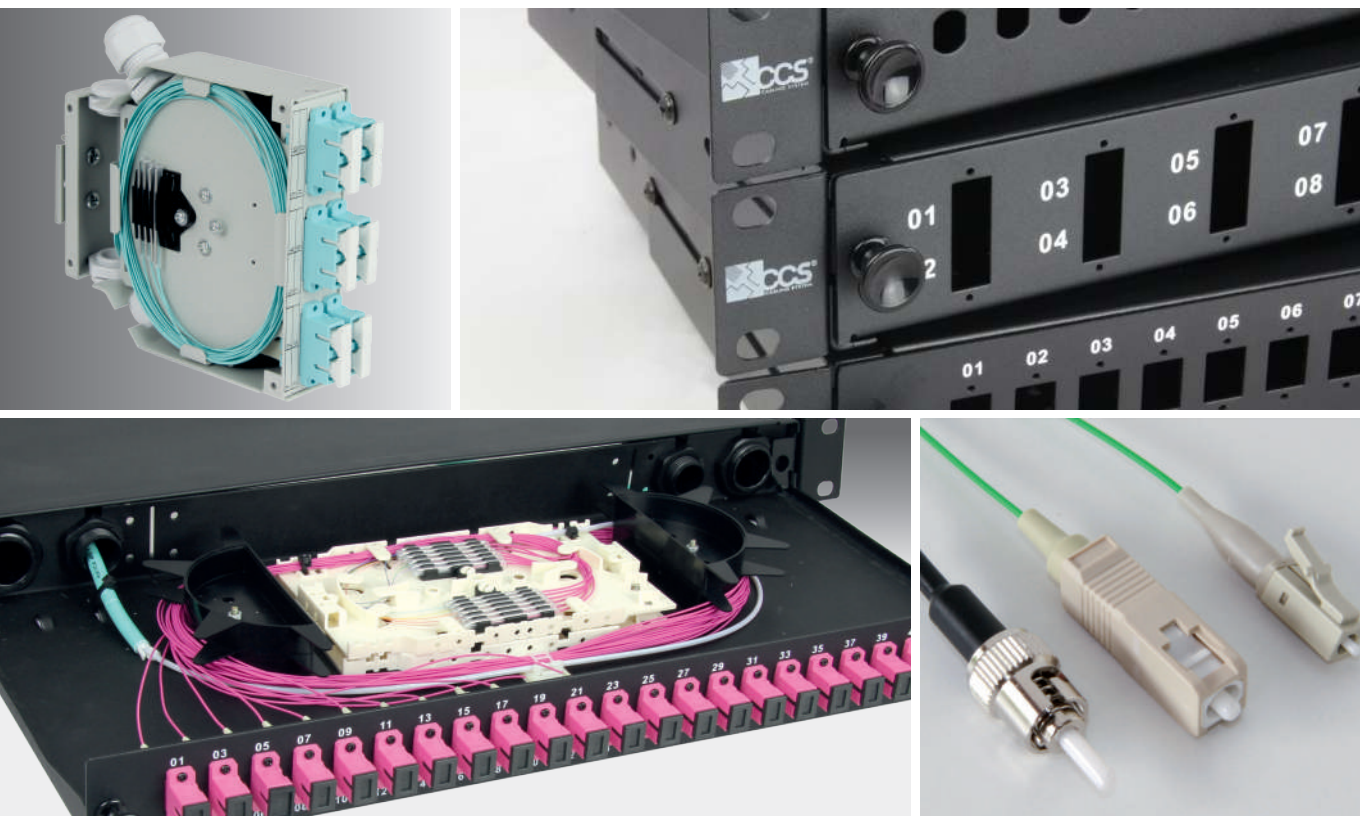

FO cabling system

CCS® offers a full range of products designed to offer high quality solutions and to satisfy all needs in the FO installations. Optical patch panels and enclosures, adapters, pigtails and patch cords are some of the articles included in our portfolio.

CCS® system includes products for the use of single-mode and multimode optical fibers OM1, OM2, OM3 and OM4 versions.

Patch panels	p. 98
Wall mount enclosures	p. 102
DIN-rail optical boxes	p. 103
Multimedia box and Accessories	p. 104
Keystone adapters	p. 105
Adapters	p. 106
Protection systems	p. 107
Pigtails	p. 108
Bifiber patch cords	p. 110
Closure and Accessories	p. 115

Fiber optic cabling system

Modular patch panel

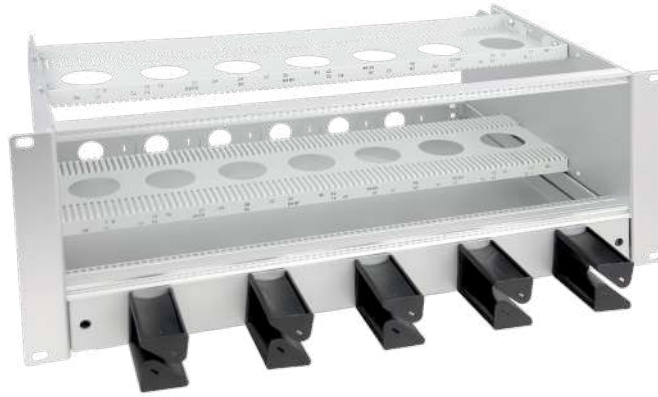

Modular fiber optic patch panel 4U

Description

Modular fiber optic patch panel 4U, suitable for the splicing and connection of fiber optic cables into 19" racks. It consists of a 3U frame with front opening, which hosts up to 12 optical modules to manage up to 288 fibers, and a 1U pullout tray, equipped with 5 front rings for the horizontal cable management and with 12 pre-sheared rear PG16 holes for the cable inlet. The patch panel can be fitted with different optical modules according to the specific needs, listed at page 87.

Reference standards

IEC 60297
DIN 41494

General characteristics

Installation	On 19" racks; front mounting on uprights
Structure	Zinc-plated aluminum sheet frame with front opening, 3U; pullout tray 1U with 5 front plastic rings and with 12 rear PG16 holes.
Max.No. of modules	12
Max. No. of fibers	288
Units	4 Units
Dimensions	W483xD300xH177 mm
Colour	Frame : Grey Cable management rings: Black

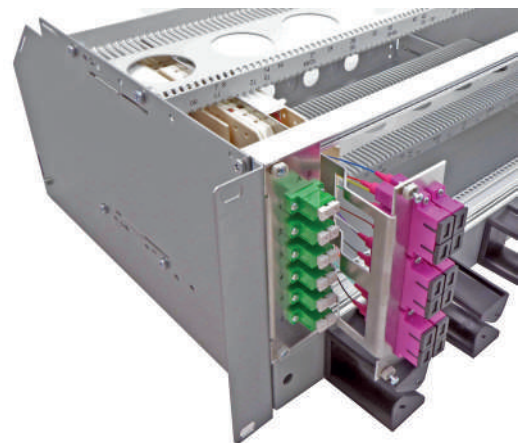

Code	Description	Packaging
2006080	19" modular FO patch panel 4U	1 pc

Fiber optic cabling system

Optical modules

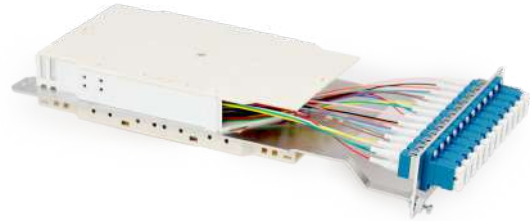
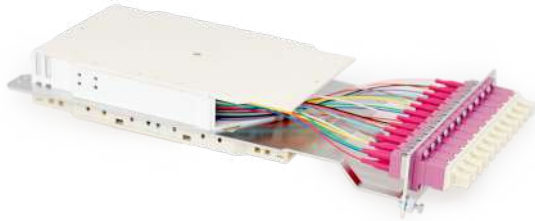

Optical modules for patch panel 4U

Description

Fiber optic termination modules fit for the installation in the modular fiber optic patch panel 4U.

The modules are made of a 6 or 12-port front panel with adapters, a plastic body with an integrated system for the management of pigtailed and optical fibers and they are equipped with a splice tray with organizer to protect the splices.

Models available are with 6/12 LC Duplex adapters or 12 SC Simplex adapters and they also include pigtailed.

Compatible fiber optic cables: multimode 50/125 OM3 and OM4 and single-mode 9/125.

General characteristics

Installation	On modular fiber optic patch panel 4U
Structure	6 or 12-port front panel with adapters and pigtailed, plastic body UL94V-O with an integrated system for the management of pigtailed and optical fibers; plastic splice tray UL94V-O equipped with organizer, cover and holder to fix the fiber optic cable.
Models	6 LC Duplex adapters with 12 LC pigtailed 12 SC Simplex adapters with 12 SC pigtailed 12 LC Duplex adapters with 24 LC pigtailed
Type of fibers	50/125 OM3-OM4, 9/125 OS2
Dimensions	W35xD268xH129 mm
Colour	Front panel : Grey Body and splice tray : White

Module type	SM 9/125	MM 50/125 OM3	MM 50/125 OM4
6 LC Duplex	2006083	2006085	2006088
12 SC Simplex	2006084	2006086	2006089
12 LC Duplex	2006082	2006087	2006081

Fiber optic cabling system

Patch panels



2006005



2006006

Fiber optic patch panels 24-port SC Simplex and 12/24-port SC Duplex

Description

12 or 24-blank port sliding fiber optic patch panels, suitable for the splicing and connection of fiber optic cables into 19" racks. They are equipped with a pullout tray with cable guide and slotted holes connected to the cable inlet system, thus making installation much easier. Fast opening and closing of the tray is ensured by two frontal fastening rivets. The mounting brackets, adjustable in depth, allow the installation of the patch panel also into racks of reduced depth.

Supplied with caps, cable glands and ties for managing and fastening of the optical fibers.

Reference standards

IEC 60297
DIN 41494

General characteristics

Installation	On 19" racks with minimum depth of 420mm; front mounting on uprights
Structure	Varnished sheet steel frame; pullout tray with 12 or 24 ports according to the model; 4 rear cable inlets; 2 semicircular cable management plastic guides; mounting brackets adjustable in depth
Ports	12/24 blank ports for SC Duplex adapters 24 blank ports for SC Simplex or LC Duplex adapters
Equipment	2 cable glands for securing the optical cables; ties for cabling management; caps for port closing; screws kit for adapters (only for codes 2006005/2006006)
Units	1 Unit
Dimensions	W482xD210xH44,5 mm
Colour	Black

Code	Description	Packaging
2006005	19" sliding FO patch panel, 24 blank ports for SC Simplex, LC Duplex adapters -1U	1 pc
2006006	19" sliding FO patch panel, 12 blank ports for SC Duplex adapters - 1U	1 pc
2006017	19" sliding FO patch panel, 24 blank ports for SC Duplex adapters, 1U	1 pc

Fiber optic cabling system

Patch panels



Fiber optic patch panel 24-port ST

Description

24-blank port sliding fiber optic patch panel, suitable for the splicing and connection of fiber optic cables into 19" racks. It is equipped with a sliding tray with cable guide and slotted holes connected to the cable inlet system, thus making installation much easier. Fast opening and closing of the tray is ensured by two frontal fastening rivets. The mounting brackets, adjustable in depth, allow the installation of the patch panel also into racks of reduced depth. Supplied with caps, cable glands and ties for managing and fastening of the optical fibers.

Reference standards

IEC 60297
DIN 41494

General characteristics

Installation	On 19" racks with minimum depth of 420mm; front mounting on uprights
Structure	Varnished sheet steel frame; pullout tray with 24 ports; 4 rear cable inlets; 2 semicircular cable management plastic guides; mounting brackets adjustable in depth
Ports	24 blank ports for ST adapters
Equipment	2 cable glands for securing the optical cables; ties for cabling management; caps for port closing; screws kit for adapters
Units	1 Unit
Dimensions	W482xD210xH44,5 mm
Colour	Black

Code	Description	Packaging
2006004	19" sliding FO patch panel, 24 blank ports for ST adapters - 1U	1 pc

Fiber optic cabling system

Wall mount enclosures



IP65 MDU box

Description

IP 65 MDU box for multi-fiber building systems for the distribution of the antenna and satellite optical signals or internet connectivity through wireless systems.

Both for indoor and outdoor installations, on wall or pole, it is designed for FTTH and FTTB systems for cable-to-cable in line splices and terminations through pigtailed or connectors.

Characteristics

Installation	Wall or pole
Structure	Sturdy structure with ABS body, 180°C opening door, lockable with safety key, 2 cable inlets with glands, 12 cable inlets for drop cables or Simplex patch cords, integrated splice tray for 24 splices and over length fibre storage.
No. of ports	12 or 24 for SC Simplex or LC Duplex adapters
Dimensions	W250xD215xH75 mm
Protection degree	IP65

Reference standard

EN 60529

Code	Description
2006030	12-port MDU box - blank
2006032	24-port MDU box - blank

24-port wall mount fiber optic enclosure for ST and SC adapters

Description

24-blank port wall mount enclosures for ST and SC Simplex adapters with two separated sections: one for hosting cables and splice trays with top and bottom cables inlet; the other for patch cords management and cabling maintenance.

Characteristics

Installation	Wall mount
Structure	Varnished sheet steel frame divided into two sections; 24 ports compatible with ST and SC adapters; holder for fixing splice trays; key lock
No. of ports	24 for SC Simplex or ST adapters
Dimensions	W365xD105xH318 mm
Protection degree	IP20
Colour	Grey RAL 7035

Reference standard

EN 60529

Code	Description
2006015	24-port blank wall mount FO enclosure for SC adapters
2006016	24-port blank wall mount FO enclosure for ST adapters

Fiber optic cabling system

DIN-rail optical boxes

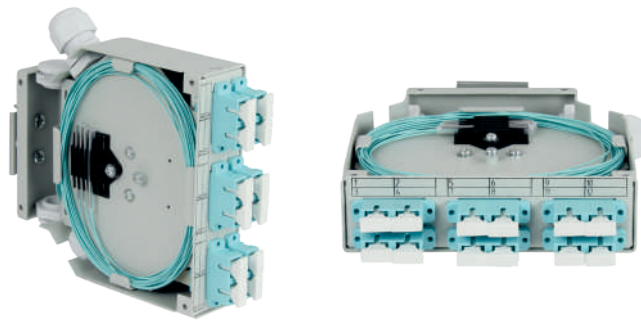

4/6-port DIN-rail boxes

Description

Optical boxes for industrial applications. Suitable for the installation on DIN-rails, they host up to 12 optical fibres.

Equipped with integrated splice trays organizer, they are available in three models:

4-blank port for ST adapters

6-blank port for SC Duplex adapters

6-blank port for SC Simplex adapters

Performance

IEC 60529

General characteristics

Installation	On DIN-rail
Structure	Varnished steel frame; 4 or 6-blank port front panel fit for ST or SC adapters; integrated splice trays organizer, cable inlet through 2 dedicated holes for PG11 cable glands
Max. No. of managed fibres	12
Dimensions	W125xD35xH136 mm
Protection degree	IP20
Colour	Grey RAL 7035

Code	Description	Packaging
2006071	6-port DIN rail optical box for 6 SC Duplex adapters	1 pc
2006072	6-port DIN rail optical box for 6 SC Simplex adapters	1 pc
2006073	4-port DIN rail optical box for 4 ST adapters	1 pc
2007083	Blinding insert SC Simplex	1 pc
2007084	Blinding insert SC Duplex	1 pc

Fiber optic cabling system

Multimedia box and Accessories

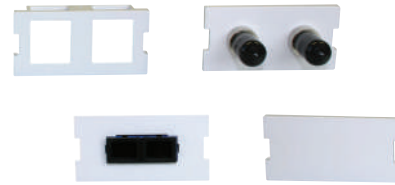

Multimedia box

Description

Wall mount multimedia box that can contain up to 3 modules (to be ordered separately) for the copper and fiber optic link connections.

General characteristics

Structure	Flame retardand thermoplastic material with high mechanical resistance; label holder window for jacks identification, coloured icons
Dimensions	W180xD150xH35 mm
Installation	Wall mount
Colour	White

Code	Description
2004070	Wall mount multimedia box

Modules for multimedia box

Description

Modules for multimedia box. They are available in different versions for the connection to both copper and fiber systems.

General characteristics

Structure	Thermoplastic with high mechanical resistance
Types	2-position module for Keystone jacks 2 ST MM adapters 1 SC Duplex MM adapter 1 blind module
Installation	On multimedia boxes
Colour	White

Code	Description
2004074	2-port blank module, Keystone standard
2004071	Module with 2 ST-ST adapters
2004072	Module with 1 SC-Duplex adapter
2004073	Blind module for multimedia box

Fiber optic cabling system

Keystone adapters

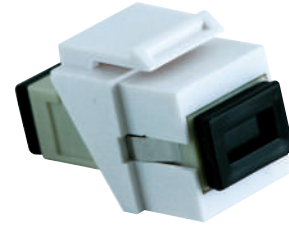
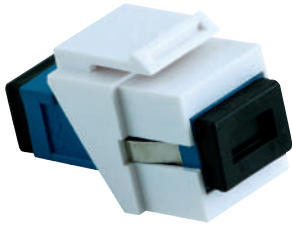

SC-SC single-mode adapters

Characteristics

- SC/SC Simplex connection
- For single-mode fibers
- Keystone snap-in
- Installation on multimedia boxes, faceplates or CCS empty panels

Code
2004089
Description
SC-SC Keystone adapter for single-mode fiber

SC-SC multimode adapters

Characteristics

- SC/SC Simplex connection
- For multimode fibers
- Keystone snap-in
- Installation on multimedia boxes, faceplates or CCS empty panels

Code
2004088
Description
SC-SC Keystone adapter for multimode fiber

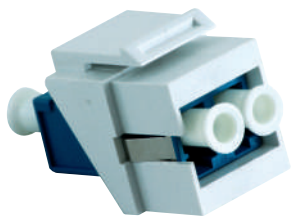

LC-LC Duplex single-mode adapters

Characteristics

- LC/LC Duplex connection
- For single-mode fibers
- Keystone snap-in
- Installation on multimedia boxes, faceplates or CCS empty panels

Code
2004091
Description
LC-LC Duplex Keystone adapter for single-mode fiber

LC-LC Duplex multimode adapters

Characteristics

- LC/LC Duplex connection
- For multimode fibers
- Keystone snap-in
- Installation on multimedia boxes, faceplates or CCS empty panels

Code
2004090
Description
LC-LC Duplex Keystone adapter for multimode fiber

Fiber optic cabling system

Adapters



Adapters for single-mode and multimode fibers

Description

Simplex or duplex adapters for coupling single-mode or multimode connectors inside fiber optic patch panels or boxes.

Characteristics

Material	Thermoplastic or metal structure (for ST adapters), phosphor bronze sleeve or Zirconia for ST adapters.
Connection	ST, SC, SC Duplex or LC Duplex
Installation	On fiber optic patch panel or box
Fiber	Single-mode or multimode
Insertion loss	SM: typical 0,15 dB MM: typical 0,20 dB
Colour	Single-mode: Blue / Green (APC) Multimode OM1/OM2: Beige Multimode OM3: Aqua Multimode OM4: Erika ST adapters - Single-mode: red cap Multimode OM1/OM2: black cap

Reference standard

ANSI/TIA 568.3-D
IEC 61754
IEC 60874

Type	SM 9/125 OS2	MM 50/125 OM2	MM 50/125 OM3	MM 50/125 OM4	MM 62,5/125 OM1
Adapter ST	2007003	2007001	-	-	2007001
Adapter SC	2007021	2007011	2007011OM3	2007011OM4	2007011
Adapter SC Duplex	2007022	2007012	2007012OM3	2007012OM4	2007012
Adapter SC/APC-SC/APC	2007021APC	-	-	-	-
Adapter LC Duplex	2007023	2007013	2007013OM3	2007013OM4	2007013

Fiber optic cabling system

Protection systems

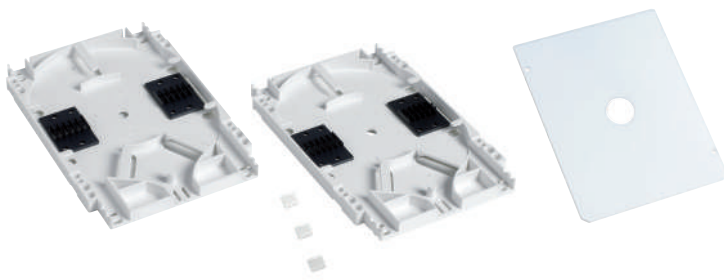

Splice trays

Description

Modular and stackable splice trays with cover. Each tray has 2 organizers which can hold 6 splices each.

The following items are available:

- Base unit
- Additional unit
- Cover for splice tray

Characteristics

Installation	On enclosures or optical trays
Material	Thermoplastic with high mechanical resistance
Capacity	12 splices
Colour	White

Code	Description
2008195	12 FO splice tray
2008196	Additional 12 FO splice tray
2008193	Cover for splice trays

Protection tubes

Description

Reinforced heat shrink tubes, standard length 45 mm and 60 mm against crushing and bending.

Ideal to protect fusion splices.

Characteristics

Installation	On fusion splices
Material	Heat-shrink material reinforced with inner stainless steel protection
Lengths	45/60 mm
Outer diameter	2,5/3,5 mm
Colour	Transparent

Code	Description
2008191	Heat-shrink tubes: diam. 2,5-3,5mm , L 45mm
2008192	Heat-shrink tubes: diam. 2,5-3,5mm , L 60mm

Fiber optic cabling system

Pigtails

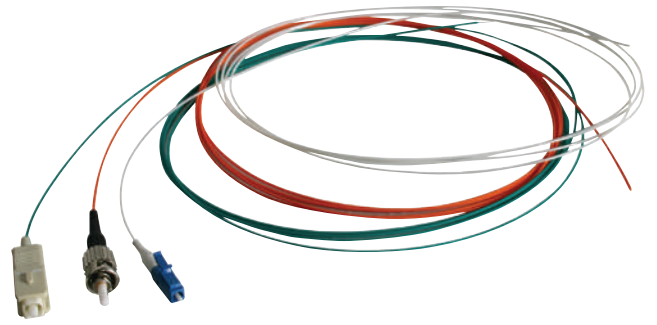
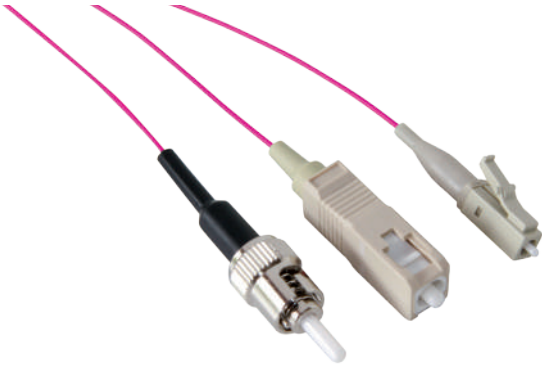

ST/SC/LC pigtails

Description

ST, SC and LC pigtails for the termination of single-mode and multimode optical fibers by electric arc fusion splicing. Pigtails with different types of connectors are available upon request.

Characteristics

Connection	ST, SC, LC, SC/APC
Cable type	Simplex semi-loose
Fiber type	Single mode or multimode
Insertion loss	SM: typical 0,15 dB MM: typical 0,20 dB
Length	2 mt
Packaging	Each pigtail is individually packed with test report included

Reference standards

ANSI/TIA 568.3-D
IEC 60874
IEC 61754

Type	SM 9/125 OS2	MM 50/125 OM2	MM 50/125 OM3	MM 50/125 OM4	MM 62,5/125 OM1
ST pigtail	2008037	2008033	2008033OM3	2008033OM4	2008035
SC pigtail	2008038	2008034	2008034OM3	2008034OM4	2008036
SC/APC pigtail	2008038APC	-	-	-	-
LC pigtail	2008029	2008019	2008019OM3	2008019OM4	2008020

Fiber optic cabling system

Easy strip pigtails

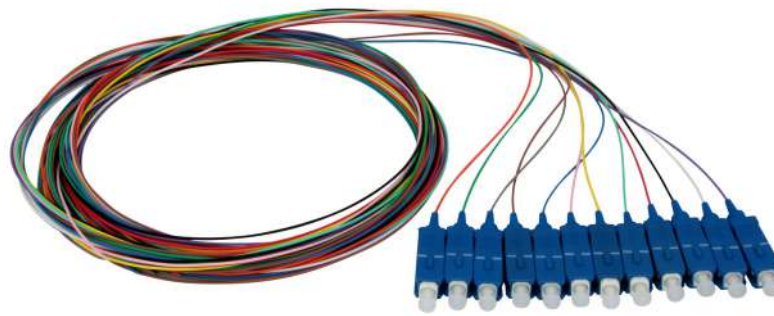

SC/LC EasyStrip pigtails

Description

Set of 12 coloured SC and LC pigtails for the termination of single-mode and multimode 50/125 OM2, OM3 and OM4 optical fibers by electric arc fusion splicing.

Characteristics

Connection	LC-PC, SC-PC
Cable type	Easy strip
Fiber type	Single-mode 9/125 and Multimode 50/125 OM2, OM3, OM4
Insertion loss	$\leq 0,3$ dB
Length	2 mt
Installation	Optical patch panels or boxes
Packaging	12 pigtails in plastic bag

Reference standards

ANSI/TIA 568-3.D
IEC 60874
IEC 11801

Code	Description	Packaging
2008017	Set of 12 pigtails 9/125 G652D LC EasyStrip	1 pc
2008018	Set of 12 pigtails 9/125 G652D SC EasyStrip	1 pc
2008015	Set of 12 pigtails 50/125 OM2 LC EasyStrip	1 pc
2008016	Set of 12 pigtails 50/125 OM2 SC EasyStrip	1 pc
2008015OM3	Set of 12 pigtails 50/125 OM3 LC EasyStrip	1 pc
2008016OM3	Set of 12 pigtails 50/125 OM3 SC EasyStrip	1 pc
2008015OM4	Set of 12 pigtails 50/125 OM4 LC EasyStrip	1 pc
2008016OM4	Set of 12 pigtails 50/125 OM4 SC EasyStrip	1 pc

Fiber optic cabling system

Bifiber patch cords



ST

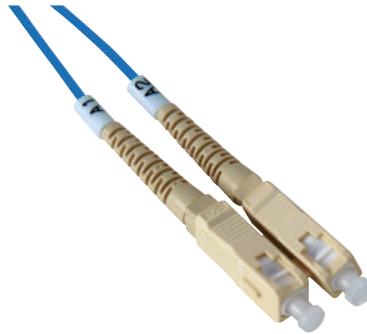

SC

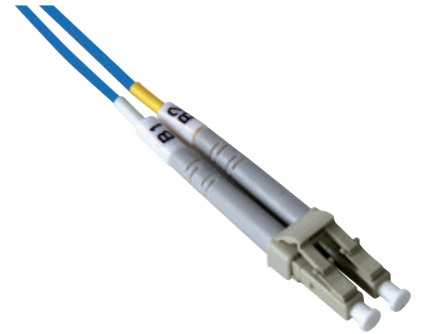

LC

Single-mode 9/125

Description

Single-mode 9/125 bifiber patch cords, terminated with suitable connectors at both ends.
 Ideal for the connection between active equipments and patch panels.
 Available from 1mt to 5mt standard length. Patch cords of different lengths can be supplied upon request.

Characteristics

Termination	ST/ST, SC/SC, ST/SC, ST/LC, SC/LC, LC/LC
Cable	Duplex Semi-Tight with LSZH (Low Smoke Zero Halogen) jacket
Fiber	Single-mode 9/125
Insertion loss	0,15 dB
Operating temperature	From -20° C to 60° C
Packaging	Every patch cord is individually packed
Cable colour	Blue

Reference standards

ISO/IEC 11801-1/2:2017
 EIA/TIA 568.3-D
 IEC 61754; IEC 60874

Length	ST patch cord	SC patch cord	ST/SC patch cord	ST/LC patch cord	SC/LC patch cord	LC patch cord
1 mt	2008250	2008254	2008258	2008270	2008266	2008262
2 mt	2008251	2008255	2008259	2008271	2008267	2008263
3 mt	2008252	2008256	2008260	2008272	2008268	2008264
5 mt	2008253	2008257	2008261	2008273	2008269	2008265

Fiber optic cabling system

Bifiber patch cords



ST

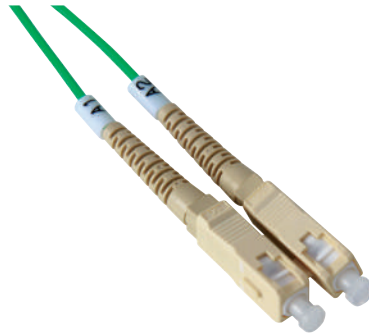

SC

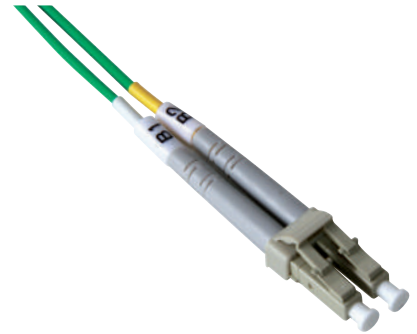

LC

Multimode 50/125 OM2

Description

Multimode 50/125 OM2 bifiber patch cords, terminated with suitable connectors at both ends. Ideal for the connection between active equipments and patch panels. Available from 1mt to 5mt standard length. Patch cords of different lengths can be supplied upon request.

Characteristics

Termination	ST/ST, SC/SC, ST/SC, ST/LC, SC/LC, LC/LC
Cable	Duplex Semi-Tight with LSZH (Low Smoke Zero Halogen) jacket
Fiber	Multimode 50/125 OM2
Insertion loss	0,2 dB
Operating temperature	From -20° C to 60° C
Packaging	Every patch cord is individually packed
Cable colour	Green

Reference standards

ISO/IEC 11801-1/2:2017
EIA/TIA 568.3-D
IEC 61754; IEC 60874

Length	ST patch cord	SC patch cord	ST/SC patch cord	ST/LC patch cord	SC/LC patch cord	LC patch cord
1 mt	2008021	2008025	2008039	2008149	2008135	2008131
2 mt	2008022	2008026	2008030	2008140	2008136	2008132
3 mt	2008023	2008027	2008031	2008141	2008137	2008133
5 mt	2008024	2008028	2008032	2008142	2008138	2008134

Fiber optic cabling system

Bifiber patch cords



ST

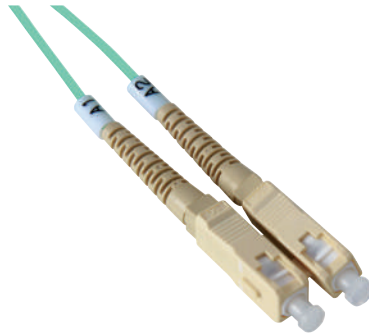

SC

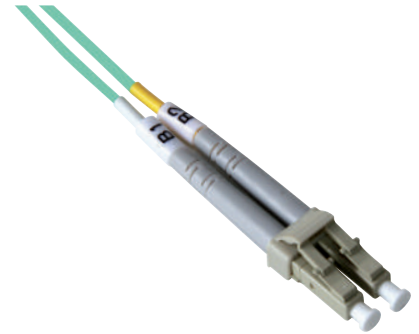

LC

Multimode 50/125 OM3

Description

Multimode 50/125 OM3 bifiber patch cords, terminated with suitable connectors at both ends.
 Ideal for the connection between active equipments and patch panels.
 Available from 1mt to 5mt standard length. Patch cords of different lengths can be supplied upon request.

Characteristics

Termination	ST/ST, SC/SC, ST/SC, ST/LC, SC/LC, LC/LC
Cable	Duplex Semi-Tight with LSZH (Low Smoke Zero Halogen) jacket
Fiber	Multimode 50/125 OM3
Insertion loss	0,2 dB
Operating temperature	From -20° C up to 60° C
Packaging	Every patch cord is individually packed
Cable colour	Aqua

Reference standards

ISO/IEC 11801-1/2:2017
 EIA/TIA 568.3-D
 IEC 61754; IEC 60874

Length	ST patch cord	SC patch cord	ST/SC patch cord	ST/LC patch cord	SC/LC patch cord	LC patch cord
1 mt	20080210M3	20080250M3	20080390M3	20081490M3	20081350M3	20081310M3
2 mt	20080220M3	20080260M3	20080300M3	20081400M3	20081360M3	20081320M3
3 mt	20080230M3	20080270M3	20080310M3	20081410M3	20081370M3	20081330M3
5 mt	20080240M3	20080280M3	20080320M3	20081420M3	20081380M3	20081340M3

Fiber optic cabling system

Bifiber patch cords



ST

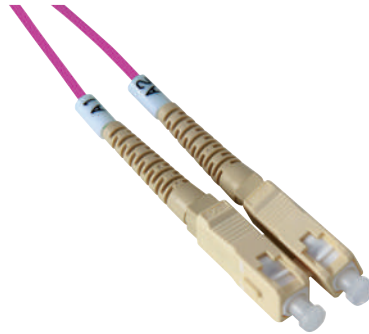

SC

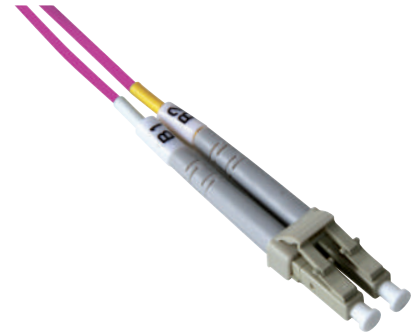

LC

Multimode 50/125 OM4

Description

Multimode 50/125 OM4 bifiber patch cords, terminated with suitable connectors at both ends.
Ideal for the connection between active equipments and patch panels.
Available from 1mt to 5mt standard length. Patch cords of different lengths can be supplied upon request.

Characteristics

Termination	ST/ST, SC/SC, ST/SC, ST/LC, SC/LC, LC/LC
Cable	Duplex Semi-Tight with LSZH (Low Smoke Zero Halogen) jacket
Fiber	Multimode 50/125 OM4
Insertion loss	0,2 dB
Operating temperature	From -20° C up to 60° C
Packaging	Every patch cord is individually packed
Cable colour	Erika

Reference standards

ISO/IEC 11801-1/2:2017
EIA/TIA 568.3-D
IEC 61754; IEC 60874

Length	ST patch cord	SC patch cord	ST/SC patch cord	ST/LC patch cord	SC/LC patch cord	LC patch cord
1 mt	20080210M4	20080250M4	20080390M4	20081490M4	20081350M4	20081310M4
2 mt	20080220M4	20080260M4	20080300M4	20081400M4	20081360M4	20081320M4
3 mt	20080230M4	20080270M4	20080310M4	20081410M4	20081370M4	20081330M4
5 mt	20080240M4	20080280M4	20080320M4	20081420M4	20081380M4	20081340M4

Fiber optic cabling system

Bifiber patch cords



ST

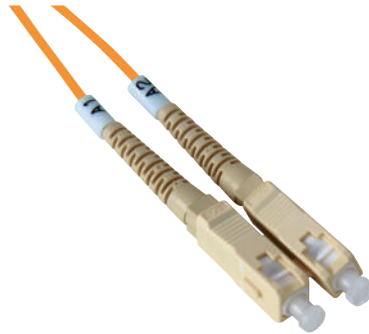

SC

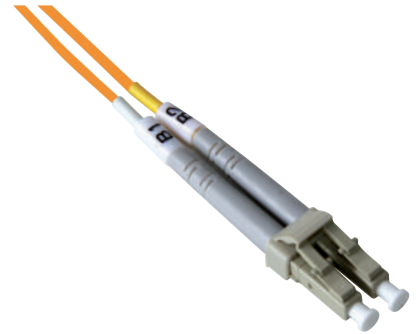

LC

Multimode 62.5/125 OM1

Description

Multimode 62,5/125 OM1 bifiber patch cords, terminated with suitable connectors at both ends.
Ideal for the connection between active equipments and patch panels.
Available from 1mt to 5mt standard length. Patch cords of different lengths can be supplied upon request.

Characteristics

Termination	ST/ST, SC/SC, ST/SC, ST/LC, SC/LC, LC/LC
Cable	Duplex Semi-Tight with LSZH (Low Smoke Zero Halogen) jacket
Fiber	Multimode 62,5/125 OM1
Insertion loss	0,3 dB
Operating temperature	From -20° C up to 60° C
Packaging	Every patch cord is individually packed
Cable colour	Orange

Reference standards

ISO/IEC 11801
EIA/TIA 568.3-D
IEC 61754; IEC 60874

Length	ST/ST patch cord	SC/SC patch cord	ST/SC patch cord	ST/LC patch cord	SC/LC patch cord	LC/LC patch cord
1 mt	2008001	2008005	2008009	2008119	2008115	2008111
2 mt	2008002	2008006	2008010	2008120	2008116	2008112
3 mt	2008003	2008007	2008011	2008121	2008117	2008113
5 mt	2008004	2008008	2008012	2008122	2008118	2008114

Fiber optic cabling system

Closure

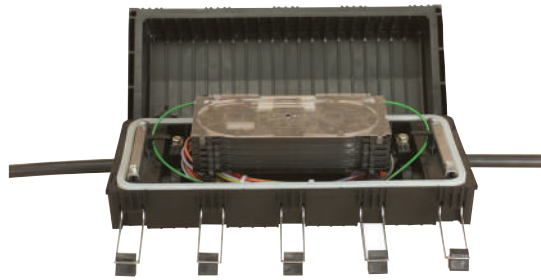

In-line splice closure UCAO MFT

Description

Splice closure suitable to contain up to 7 MFT splice trays.
The kit includes the necessary accessories to fix 2+2 cables in/out.
MFT trays (for 24 splices) are also available on demand.

Characteristics

Structure	Thermoplastic material resistant to chemical and atmospheric agents
Cables diam.	6-21 mm
Inlets	2+2
Max.tray count.	168 splices on MFT trays
Protection degree	IP68
Installation	Aerial, underground or direct burial
Colour	Black

Code	Description	Packaging
2007040	In-line splice closure UCAO MFT	1 pc

Fiber optic cabling system

Closure Accessories

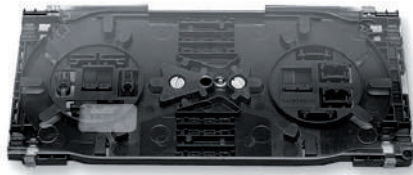
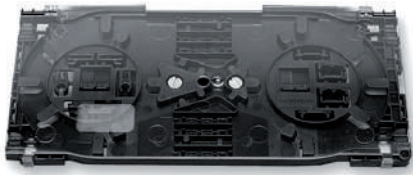

MFT splice tray

Characteristics

- Compatible with UCAO splice closure
- Structure in thermoplastic material
- Tray count 24 heat-shrink splices

Code	2007045
Description	MFT tray for 24 FO heat-shrink splices

Cover for MFT splice tray

Characteristics

- Compatible with MFT splice tray
- Structure in thermoplastic material

Code	2007046
Description	Cover for MFT splice tray

Standard splice tray

Characteristics

- Compatible with UCNP splice closure
- Structure in thermoplastic material
- Tray count 12 splices

Code	2007043
Description	Standard tray for 12 FO splices



Cover for standard splice tray

Characteristics

- Compatible with standard splice tray
- Structure in thermoplastic material

Code	2007044
Description	Cover for standard splice tray

6 FO splices organizer

Characteristics

- Compatible with standard trays
- Structure in thermoplastic material
- Tray count 6 heat-shrink splices

Code	2007041
Description	6 FO splices organizer for standard tray



Fiber optic termination

CCS® Fiber optic product range includes tools for the termination of optical cables in the field.

The optical cable is connected to a pigtail with the same type of fiber and suitable connector through a fusion splicer. The choice of the fusion splicer grants minimal losses on the link.

Cleaning Accessories are also to be found in our range.

Fusion splicer	p. 118
Cleaver	p. 120
Cleaning Accessories	p. 121
Stripper, crimping tool	p. 122

Fiber optic termination

Fusion splicer



Clad alignment fusion splicer

Description

Fusion splicer, with adaptive clad alignment type V-Groove for the splicing of single-mode and multimode optical fibers or pigtails. The ends of the two optical fibers to splice, after proper alignment, are spliced by ensuring absolute continuity of the optical wave guide. Splicing is obtained by heating the fibers through an electric arc.

Reference standard

ISO/IEC 11801
ANSI/TIA 568.3-D

General characteristics

Splice method	Clad alignment with DAA (Digitalized Active Alignment) system
Typical Loss	From 0,01 to 0,04 dB
Return Loss	>60 dB
Suitable fiber types	SM (ITUG.652), MM (ITU G.651), DS (ITU G.653), NZDS (ITU G.655), ITU G.657A, ITU G.657B
Electrode lifespan	>5500 electric arcs
Splice time	10 seconds
Monitor	Colour LCD 4,3" with Touch Screen
Weight	1,39 kg (without battery)
Dimensions	122x124x138 mm
Operating environment	-20° +60°C, max. humidity 95%
Equipment	Splicer, cleaver, stripper, power cord, USB cable, cooling tray, 2 battery packs, spare electrodes, adapters for SOC connectors, CD manual, hand carrying case

Code	Description	Packaging
2040162	Clad Alignment fusion splicer Mini 4S+	1 pc

Fiber optic termination

Fusion splicer



Core alignment fusion splicer

Description

Fusion splicer, with core alignment type V-Groove for the splicing of single-mode and multimode optical fibers or pigtails. The ends of the two optical fibers to splice, after proper alignment, are spliced by ensuring absolute continuity of the optical wave guide. Splicing is obtained by heating the fibers through an electric arc. The splicer uses a DCID (Digitalized Core Image Detecting) system for the core alignment of the fibers, features a color touchscreen with tempered glass and it's compatible with SOC connectors.

Reference standard

ISO/IEC 11801
ANSI/TIA 568.3-D

General characteristics

Splice method	Core alignment DCID (Digitalized Core Image Detecting) system
Typical Loss	From 0,01 to 0,04 dB
Return Loss	>60 dB
Suitable fiber types	SM (ITU G.652 & G.657), MM (ITU G.651), DS (ITU G.653), NZDS (ITU G.655)
Electrode lifespan	>5500 electric arcs
Splice time	6/8 seconds
Monitor	Colour LCD 4,3" with Touch Screen
Weight	1,4 kg (without battery)
Dimensions	123x124x138 mm
Operating environment	-20° +60°C, max. humidity 95%
Equipment	Splicer, cleaver, stripper, power cord, USB cable, cooling tray, 2 battery packs, spare electrodes, adapters for SOC connectors, CD manual, hand carrying case
Connectivity	Mini-USB

Code	Description	Packaging
2040356	Core Alignment fusion splicer Mini5C+	1 pc.

Fiber optic termination

Cleaver



Optical fibers cleaver for fusion splicer

Description

The Mini50GB is a high precision cleaver to be used with fusion splicers for cutting the optical fibers. The cleaver is equipped with an integrated system to place and fix the fibers, a diamond blade which allows 90° cuts with a maximum tolerance of 0,5° and a collector for the surpluses of the cut fibers.

Characteristics

FO cables	Optical fibers with 250 µm or 900 µm coating or with 2/3 mm diameter
Structure	Metal alloy with high mechanical resistance
Mechanical properties	Integrated holder for the fibers placing and fixing, sliding diamond blade, collector for cut fibers surplus
Cut angle	90± 0,5°
Cuts number	48000
Length of cut	8-20 mm
Dimensions	71x91x62 mm

Code	Description	Packaging
2040240	FO precision cleaver Mini50GB	1 pc
2040343	Spare blade for FO cleaver	1 pc

Fiber optic termination

Cleaning Accessories



Click cleaner SC-ST

Characteristics

- Suitable to clean SC, ST connectors and adapters with 2,5 mm ferrule
- Cleaning is performed with a simple press of the connector or adapter
- 800 cleaning cycles

Code
2040305
Description
Click Cleaner SC-ST

Click cleaner LC

Characteristics

- Suitable to clean LC connectors and adapters with 1,25 mm ferrule
- Cleaning is performed with a simple press of the connector or adapter
- 800 cleaning cycles

Code
2040306
Description
Click Cleaner LC



Isopropyl alcohol

Characteristics

- Suitable to clean optical fibers before splicing
- Colorless liquid with relative density of approximately 0.80 mg/ml
- Spray can 400 ml

Code
2040317
Description
Isopropyl alcohol 400 ml

Splice wipes

Characteristics

- Suitable to clean optical connectors
- One-layer fabric wipes, white colour, 11x21 cm
- Packaging unit: 280 pcs

Code
2040303
Description
Splice wipes

Fiber optic termination

Stripper, crimping tool



Fiber stripper

Description

Multi purpose stripper ideal to remove the cable jackets of cables with a diameter of 2,5 mm and the optical buffer coating of 250,600 and 900 µm.

Characteristics

Structure	Burnished steel body, handles made of thermoplastic material
Application	Fiber stripping
Mechanical features	Blades with 3 slots of different diameter depending on the fiber coating to strip
Colour	Body black Handles orange

Kevlar crimping tool

Description

Kevlar crimping tool to be used with Tight cables to fix the Kevlar to the connectors.

Characteristics

Structure	Burnished steel body, ergonomic handles made of thermoplastic material
Use	On Tight optical cables with ST/SC connectors
Mechanical features	Wheel to adjust the crimping force; crimping releasable knob
Colour	Body black Handles red

Code	Description
2040052	Fiber stripper

Code	Description
2040088	Kevlar crimping tool for ST-SC connectors



Fiber To The Home

Range of products for the realization of optical infrastructures FTTH both in new and existing buildings. CCS solution includes FO cables, MDU boxes, building entry points, OTO and all the Accessories to perform a state-of-the-art installation.

Distribution schemes	p. 124
Optical cables	p. 128
Optical telecommunication outlet	p. 130
MDU boxes	p. 131
Home consolidation cabinet	p. 134
Optical termination boxes	p. 136
Support and faceplate for OT	p. 137
Adapters	p. 138
Optical splitters	p. 139
Patch cords and pigtails	p. 140
Accessories	p. 141

FTTH System in new buildings

BACKBONE DISTRIBUTION

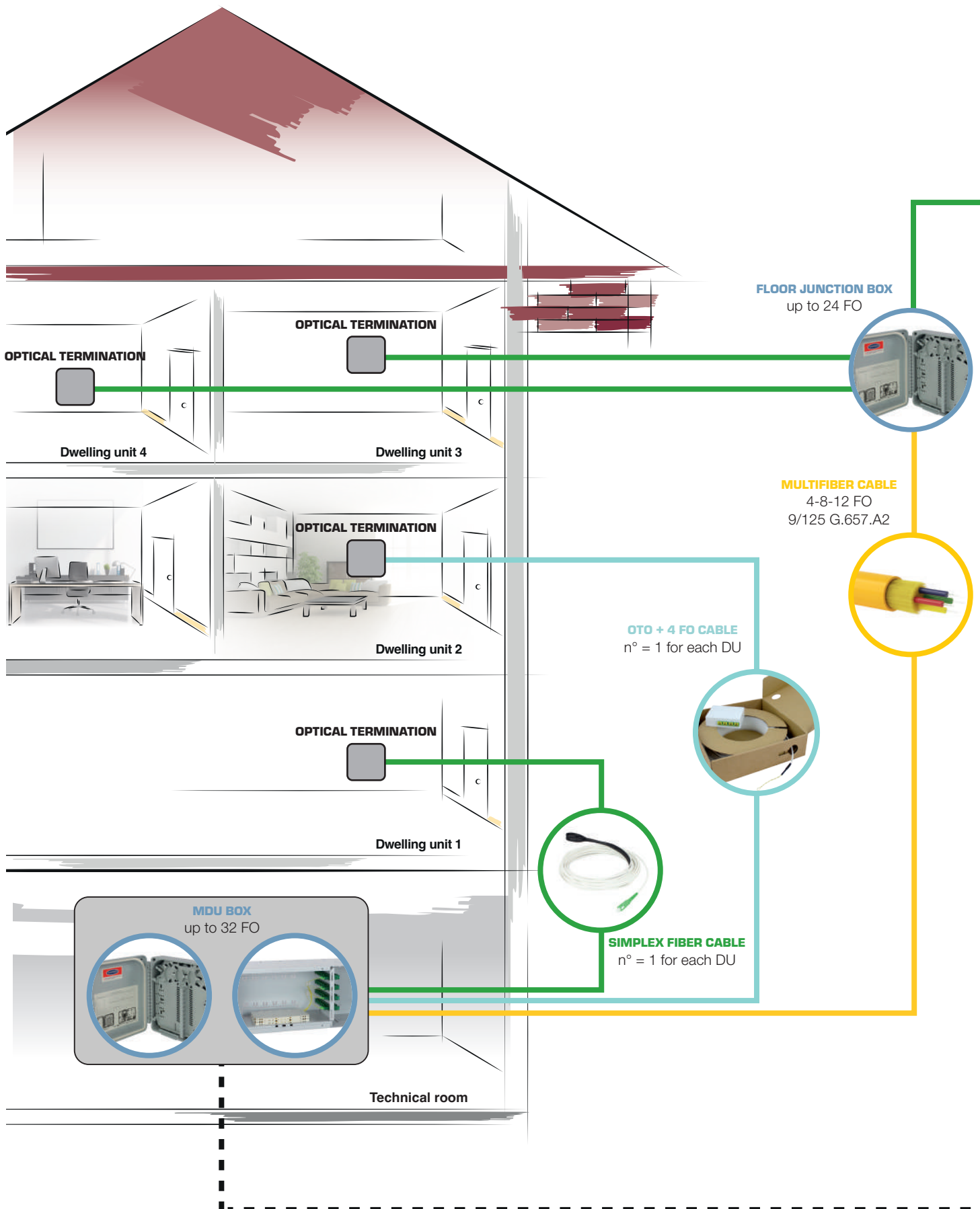

DISTRIBUTION INSIDE THE DWELLING UNIT

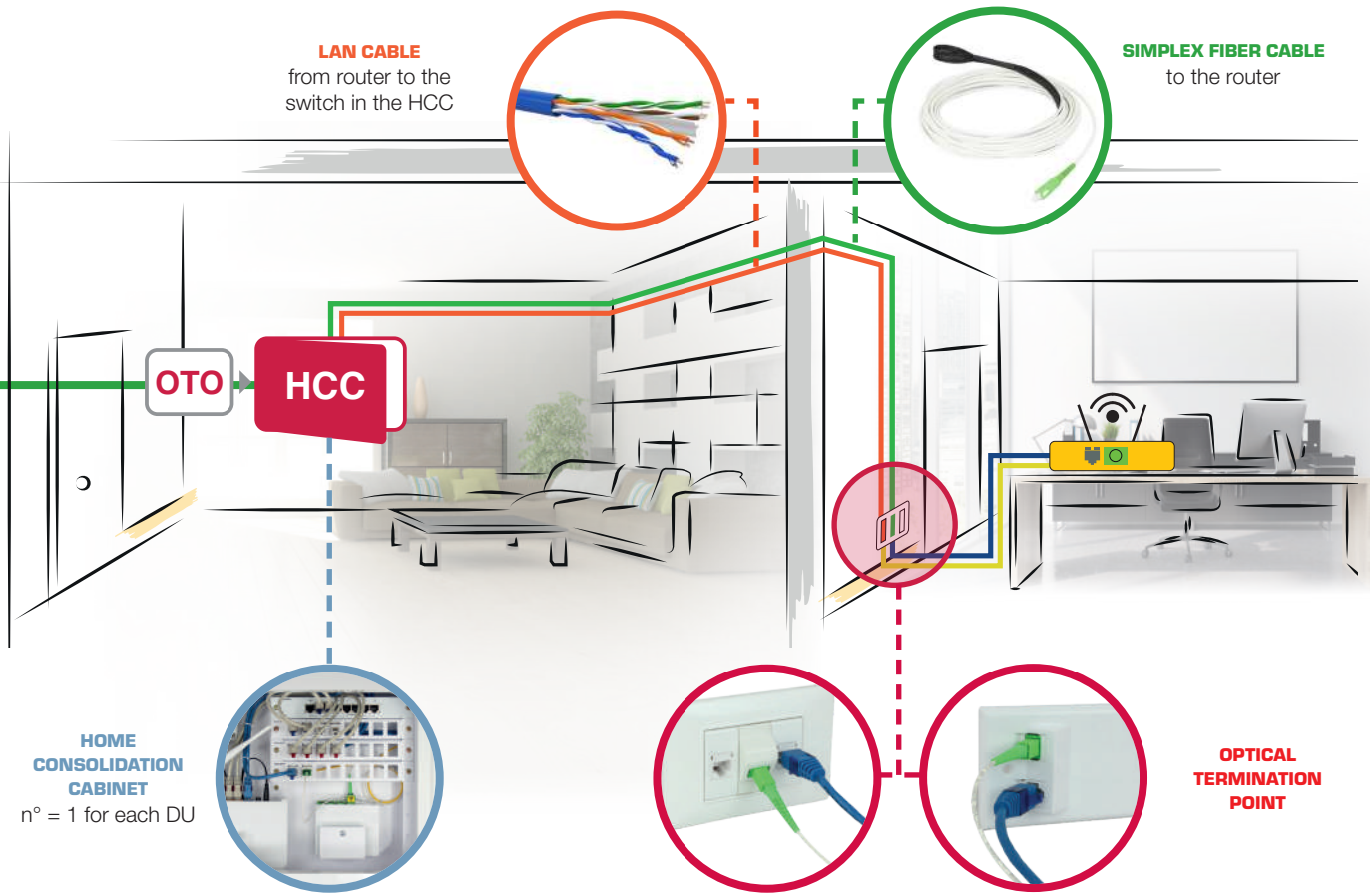

LAYOUT EXAMPLE OF CONNECTION BETWEEN ROUTER AND HCC

- LAN cable
- Simplex fiber cable
- Optical patch cord
- Copper patch cord

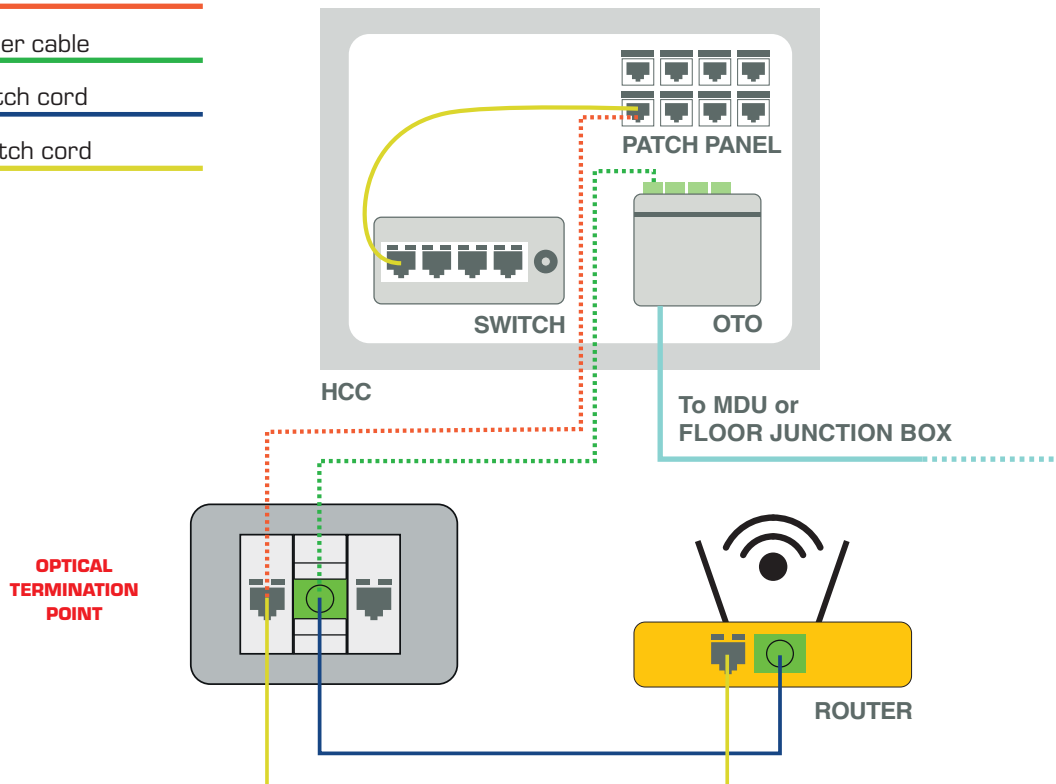

FTTH System in *existing buildings*

BACKBONE DISTRIBUTION

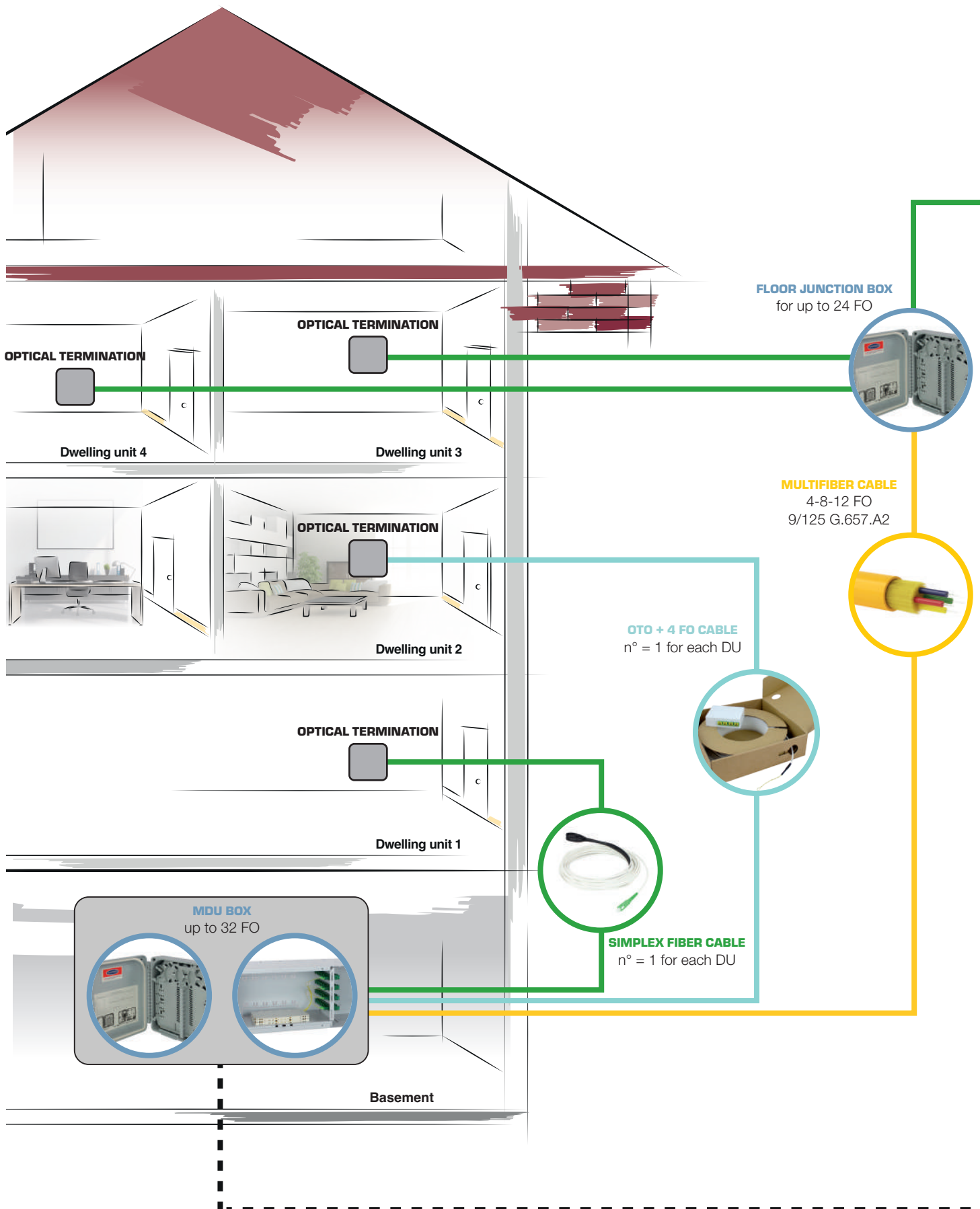

DISTRIBUTION INSIDE THE DWELLING UNIT

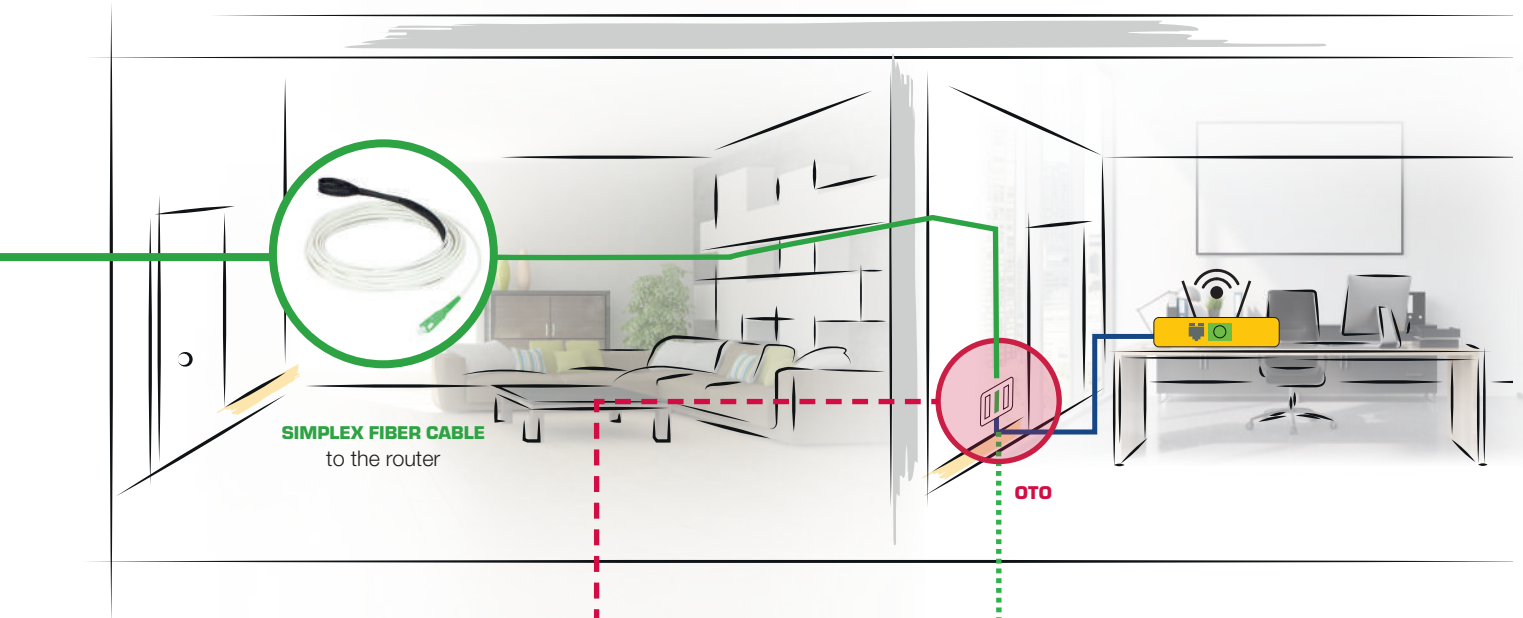

OPTICAL ADAPTER
for civil series



OPTICAL BOXES
wall-mounted



FACEPLATES
standard 503

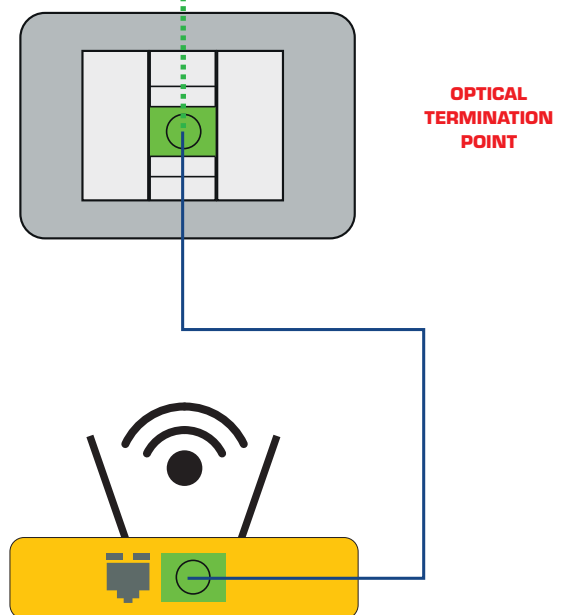

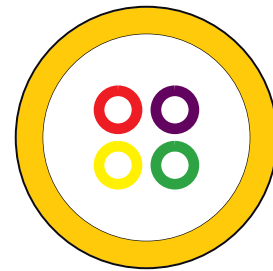
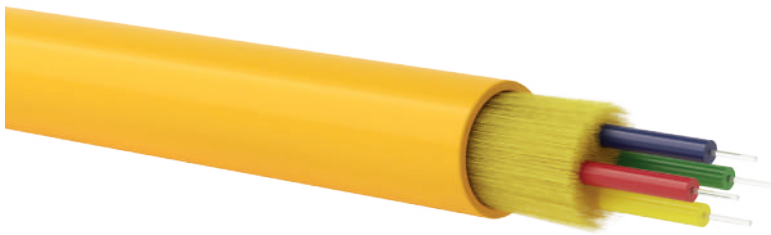

The colour of the jacket in the picture is purely informational

Multifiber bend Insensitive optical cables

4 to 12 cores indoor or outdoor fiber optic cables with single-mode fibers, 9/125 G.657.A2 Bend Insensitive, 250µm fiber primary coating.

For indoor use: minicore cables with dielectric armour of aramid yarns which grants an excellent pull force value and with LSZH (Low Smoke Zero Halogen) flame retardant outer jacket.

For outdoor use: Loose cables with Kevlar yarns fillers and PE (Polyethylene) outer jacket.

Application and performance

Cable suitable for the realisation of multifiber building cabling systems, for indoor or outdoor use.

They can be laid in pipes or ducts to connect the Building Entry Point to the Fiber Distribution Box or to the Optical Telecommunication Wall Outlet.

Certifications and approvals

Data transmission FO cables according to ITU.G657.A2 and IEC 60794-1-2

IEC 60794-1-2
ITU.G657.A2



Construction characteristics

Cable core	4-8-12 SM fibers ITU.G657.A2 Bend Insensitive
Protection filler	Aramid yarns
Material/outer jacket colour	LSZH or PE/yellow
Outer diameter	From 3 to 3,4 mm
Weight	From 10 to 13 kg/km

Mechanical and environmental characteristics

Use	Indoor or outdoor
Bend. radius during installation	15 x outer diameter
Bend. radius after installation	10 x outer diameter
Max.pull strength	Indoor cables 1000N Outdoor cables 250N
Crush test	1000 N/dm
Installation temperature	From -5°C to +50°C
Operating temperature	from -15°C to +60°C

Fire behaviour of the cables with LSZH outer jacket

CPR Regulation	EN50575 Euroclass Eca
Fire behaviour	IEC 60332-1
Smoke density	IEC 61034-1/2
Acid gas emission	IEC 60754-1/2

Code	Description	Euroclass
2008451	Indoor FO cable - 4 fibres SM 9/125 G.657.A2, LSZH jacket	Eca
2008452	Indoor FO cable - 8 fibres SM 9/125 G.657.A2, LSZH jacket	Eca
2008453	Indoor FO cable - 12 fibres SM 9/125 G.657.A2, LSZH jacket	Eca
2008456	Outdoor FO cable - 4 fibres SM 9/125 G.657.A2, PE jacket	Fca
2008457	Outdoor FO cable - 8 fibres SM 9/125 G.657.A2, PE jacket	Fca
2008458	Outdoor FO cable - 12 fibres SM 9/125 G.657.A2, PE jacket	Fca

FO cables for vertical and floor distribution



PULLING BRAID

Preterminated simplex fiber optic cable



Description

G.657.A2 single-mode, tight buffered, simplex fiber optic cable preterminated at both ends with SC/SC APC connectors. Suitable for fiber optic distributions or links in both new and existing installations. To facilitate the installation inside the conduits, one end features a braided guard with inside an SC/APC connector to be assembled.

Available in pre-wired versions with lengths of 10, 15, 20, 30, 40 and 50 m.

Applications

In fiber optic infrastructure for the connection between the home consolidation point to the optical termination point

In existing and new facilities to implement optical distribution

Characteristics

Use	Indoor
Cable features	1 single-mode G.657.A2 fiber Diameter: 3 mm Weight: 8 Kg/Km Max pulling force: 400 N Bending radius: 30 mm LSZH jacket Euroclass: Cca s1a,d0,a1
Connectors	SC/APC
Color	Cable: white Connectors: green
Lengths	10 - 15 - 20 - 30 - 40 - 50 mt



PUSH-PULL SLIM CONNECTOR

Code	Description	Packaging
2004241	Singlemode G.657.A2 simplex cable preterminated with SC/APC connectors - Euroclass Cca - 10 mt	1 pc
2004242	Singlemode G.657.A2 simplex cable preterminated with SC/APC connectors - Euroclass Cca - 15 mt	1 pc
2004243	Singlemode G.657.A2 simplex cable preterminated with SC/APC connectors - Euroclass Cca - 20 mt	1 pc
2004244	Singlemode G.657.A2 simplex cable preterminated with SC/APC connectors - Euroclass Cca - 30 mt	1 pc
2004245	Singlemode G.657.A2 simplex cable preterminated with SC/APC connectors - Euroclass Cca - 40 mt	1 pc
2004246	Singlemode G.657.A2 simplex cable preterminated with SC/APC connectors - Euroclass Cca - 50 mt	1 pc

Optical telecommunication outlet



Optical telecommunication outlet



Description

Pre-wired optical telecommunication wall outlet. Suitable to be used in multifiber building systems for the distribution of connectivity services (antenna/satellite/cable TV signals or internet) provided by the Building Entry Point. Available both blank and pre-wired with optical cables from 10 to 60 mt terminated on one or both ends.

Reference standard

IEC 60794-1-2: Fiber optic cables
IEC 60332-1-2: Flame retardant property
CPR UE/305/2011: Euroclass Eca

General characteristics

Installation	Wall or inside the Home Consolidation Cabinet
Structure	Plastic 4-port box fitted with 4 SC/APC Simplex adapters with dust-protection shutter, 1 splice tray 4 positions, indoor optical cable of preset length, 4-fibre SM type G.657.A2 pre-terminated with SC/APC adapters on one or both ends
No. of ports	4 for SC Simplex or LC Duplex adapters
Dimensions	W100xD80xH29 mm
Colour	White
Optical cable characteristics	Outer diameter: 2,5 mm Weight 30 kg/km Max pulling strength: 120N Long-term tensile strength: 100N Crush resistance: 100 N/cm Min. bend. radius (dynamic): 20 x outer diam. Min. bend. radius (static): 15 x outer diam. Operating temperature: -20/+60 °C LSZH outer sheath Euroclass Eca
Cable length	10-20-30-40-50-60 mt wired on one end 20-40-60 mt wired on both ends

Type	0 mt	10 mt	20 mt	30 mt	40 mt	50 mt	60 mt
OT outlet wired on 1 end	-	2004210	2004211	2004212	2004213	2004214	2004215
OT outlet wired on both ends	-	-	2004221	-	2004223	-	2004225
OT outlet – blank box	2004201	-	-	-	-	-	-



MDU for 4-8 building units

Description

Optical box to be used in multifiber building systems for the termination of building units optical cables.
Compatible with the main Telecom operator fiber access terminals.
Available both blank and fitted for 4/ 8 residential units.

Applications

In fiber optic infrastructures for the distribution of the optical cables to the building units

General characteristics

Installation	Wall or recessed
Structure	Steel sheet body with two separate sections : one for cable termination, the other for the patch cords connections. Equipped with cover, 180° opening door with safety key, roof and base slits, top and bottom cables inlet, sliding structure for shelves and pull-out patch panels, stockpile management with adjustable clips IF PRE-LOADED VERSION: - 4 or 8 splice trays 12 positions - 16/32 SC/SC APC adapters - 16/32 singlemode G.657.A2 SC/APC pigtails
No.of ports	32 for SC Simplex or LC Duplex adapters
Dimensions	W450xD150xH180 mm
Colour	Grey RAL 7035

Code	Description	Packaging
2006050	MDU box - pre-loaded version for 4 units	1 pc
2006051	MDU box - pre-loaded version for 8 units	1 pc
2006040	MDU box - blank version	1 pc

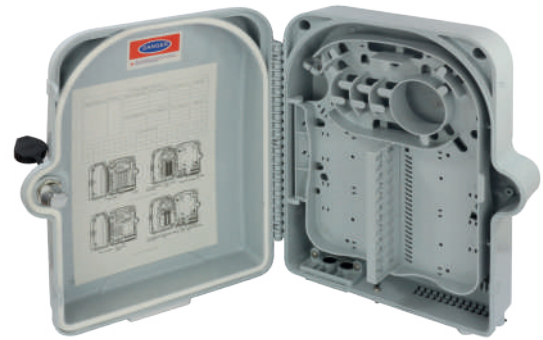

IP65 wall-mounted box 12-position SC Simplex

Description

IP65 optical box with 12 empty positions for SC Simplex adapters suitable for both indoor and outdoor environments, wall-mounted or pole-mounted. It can be used as a MDU or as junction box in multifiber building systems.

Characteristics

Installation	Wall-mounted or pole-mounted
Structure	ABS body, door can be opened up to 180° with key, 2 inlets with cable gland and 12 inlets for drop cables, built-in junction tray, 12-position holder for SC Simplex or LC Duplex adapters
Dimensions	W250xD215xH75 mm
Protection degree	IP65
Color	Grey RAL 7035

Applications

In existing and new facilities as MDU box or floor junction box

Code	Description
2006030	12-position IP65 wall-mounted box

IP65 wall-mounted box 24-position SC Simplex

Description

IP65 optical box with 24 empty positions for SC Simplex adapters suitable for both indoor and outdoor environments, wall-mounted or pole-mounted. It can be used as a MDU or as junction box in multifiber building systems.

Characteristics

Installation	Wall-mounted or pole-mounted
Structure	ABS body, door can be opened up to 180° with key, 2 inlets with cable gland and 24 inlets for drop cables, built-in junction tray, 24-position holder for SC Simplex or LC Duplex adapters
Dimensions	W275xD330xH105 mm
Protection degree	IP65
Color	Grey RAL 7035

Applications

In existing and new facilities as MDU box or floor junction box

Code	Description
2006032	24-position IP65 wall-mounted box



Pre-assembled IP65 wall-mounted box

Description

IP65 optical box pre-assembled with SC/APC adapter and pigtailed suitable for indoor and outdoor applications, wall or pole installable.

It is designed for FTTH and FTTB systems where it can be used as optical distribution box.

Applications

In FTTH infrastructures for the distribution of the optical cables to the building units

Characteristics

Installation	Wall-mounted or pole-mounted
Structure	ABS body, 180-degree opening door with safety key, 2 inlets with cable gland and 12 inlets for drop cables or optical patch cords, integrated junction tray, 12-position holder, complete with 8 SC/APC Simplex adapters, 8 single-mode SC/APC pigtailed type G.657.A2 and set of screws for wall installation
N. positions	12 for SC Simplex or LC Duplex adapters
Dimensions	W250xD215xH75 mm
Protection degree	IP65
Color	Grey RAL 7035

Code	Description	Packaging
2006031	Pre-assembled IP65 wall-mounted box	1 pc

Home Consolidation Cabinet

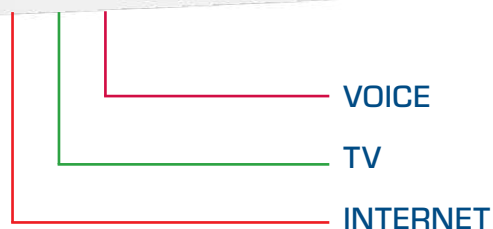

With a sober and discreet design, the HCC consists of a recessed metal structure that can lodge the passive and active components necessary for the functioning of the system. The frame of the cabinet is provided with ventilation holes for natural ventilation and has a blind plastic door of white colour. This cabinet can be used not only in FTTH installations but it is suitable for structured cabling and networks of any type like offices, shops and apartments where there is a need for contained dimensions and limited number of points.

Colour



White

Capacity

8 ways telephone splitter
24 ports RJ45

Dimensions (WxHxD)

390 x 300 x 110 mm

Installation

Recessed

Home consolidation cabinet



Home Consolidation Cabinet

Description

Recessed box to be used in multifiber building systems for the distribution of the telecommunication services (data, voice) inside a building unit.

The cabinet allows the containment of copper and FO cabling together with the necessary active equipment for the functioning of the network. It gathers and switches the services derived from the optical telecommunication wall outlet to the different points inside the apartment.

This cabinet can be used not only in FTTH installations but it is suitable for structured cabling and networks of any type like offices, shops and villas where there's a need for reduced dimensions and limited number of points.

Applications

In new or existing facilities as cabinet in the building units for the distribution of signals over copper cables

In small structured cabling systems

General characteristics

Installation	Recessed
Structure	Metal structure with cable access on the 4 sides, plastic frame and blind door. Fitted with No.1 8-ways telephone splitter, No. 3 empty 8-port patch panels for RJ45 CCS keystone jacks for data distribution, No. 3 snap-in supports to lodge the optical termination box, active equipment or accessories, No. 1 support for the installation of up to 4 additional patch panels (code 2050022), holes for the installation of an outer box for 1 or 2 power plugs, No.2 L-shape side brackets for wall mounting and protection cover.
No.of ports	8 ports pre-loaded with RJ45 telephone jacks 24 blank ports for RJ45 CCS data jacks
Dimensions	W390xD110xH300 mm
Colour	White

Code	Description	Packaging
2050005	Home Consolidation Cabinet	1 pc
2050022	Additional patch panel 8 ports	1 pc

Optical termination boxes up to 4 fibers



2-position wall-mounted optical box 70x120 mm

Description

2-position empty box for SC Simplex or LC Duplex flangeless adapters for terminating singlemode optical cables up to 4 FO. Ideal for wall installations to prepare the arrival of the fiber optic inside apartments in buildings.

Characteristics

Structure	Plastic material box
N. positions	2 ports for the installation of SC Simplex or LC Duplex flangeless adapters
N. fibers	Max. 4 FO
Dimensions	W120xD70xH24 mm
Color	White

Applications

In fiber optic infrastructures as optical termination box within buildings units



Code	Description
2004159	2-port wall optical box for flangeless adpters -70x120 mm

2-position wall-mounted optical box 80x80 mm

Description

2-position empty box compatible with SC Simplex or LC Duplex flangeless adapters for terminating singlemode optical cables up to 4 FO. Ideal for installation on German standard 80x80 mm wall boxes to prepare the fiber optic arrival inside apartments in buildings.

Characteristics

Structure	Plastic material box, metal support for fixing on 80x80 mm plate
N. positions	2 ports for the installation of SC Simplex or LC Duplex flangeless adapters
N. fibers	Max. 4 FO
Dimensions	W80xD85xH24 mm German type
Color	White

Applications

In fiber optic infrastructures as optical termination box within buildings units



Code	Description
2004160	2-port wall optical box for flangeless adpters - 80x80mm



Support for Keystone adapters

Description

Vimar Plana civil series support suitable for the installation of CCS optical Keystone adapters. Used together with item code 2004089APC, it represents an ideal solution for deriving the access to fiber services from the home consolidation cabinet to a standard 503/504 wall box.

Characteristics

Material	Thermoplastic material structure
Compatibility	CCS optical Keystone adapters
Installation	Fixing on Vimar Plana 503/504 plates
Color	White

Applications

Within building units as optical termination point or for deriving the fiber access from the HCC to the router installation point



Code	Description
2004106	Vimar Plana series support for Keystone adapters

2-position faceplate standard 503

Description

Standard 503 plate with two slanted positions for installation of CCS RJ45 jacks and optical Keystone adapters. Used in conjunction with Keystone adapter code 2004089APC and an RJ45 jack, it can allow copper and fiber connections to be derived from the HCC to a standard 503 wall box.

Characteristics

Material	Thermoplastic material structure
Positions	2 slanted ports, Keystone standard compatible
Installation	Fixing on standard 503 boxes
Compatibility	RJ45 jacks and CCS Keystone optical adapters
Colour	White

Applications

Within building units as optical termination point or for deriving the fiber access from the HCC to the router installation point



Code	Description
2004158	Faceplate with two slanted positions - standard 503



SM SC/SC APC adapter

Description

Singlemode SC/SC APC Simplex adapter for coupling singlemode fiber connectors within MDUs or optical termination and distribution boxes.

Characteristics

Material	Thermoplastic material structure
Connection	SC/SC Simplex APC
Installation	In MDUs or optical distribution or termination boxes
Fiber	Singlemode
Insertion Loss	Typical 0,15 dB
Colour	Green

Code	2007021APC
Description	Singlemode SC/SC APC Simplex adapter

SM SC/SC APC adapter flangeless type

Description

Singlemode SC/SC APC Simplex flangeless-type adapter for mating singlemode fiber connectors, to be used in the 2-position wall-mounted optical boxes codes 2004159 and 2004160.

Characteristics

Material	Thermoplastic material structure
Connection	SC/SC Simplex APC flangeless
Installation	In 2-position wall-mounted optical termination boxes
Fiber	Singlemode
Insertion Loss	Typical 0,2 dB
Colour	Green

Code	2007021FAPC
Description	Singlemode SC/SC APC Simplex adapter Flangeless type

SM SC/SC APC adapter Keystone type

Description

Singlemode SC/SC APC Simplex adapter with Keystone snap-in suitable for the installation in Vimar civil series adapter code 2004106 or in the 2-slanted position plate code 2004158.

Characteristics

Material	Thermoplastic material structure
Connection	SC/SC Simplex APC
Installation	Fixing on civil series adapters or plates with Keystone type connection
Fiber	Singlemode
Insertion Loss	Typical 0,15 dB
Colour	Body: white Adapter: green

Code	2004089APC
Description	Singlemode SC/SC APC Simplex adapter Keystone type

Optical splitters

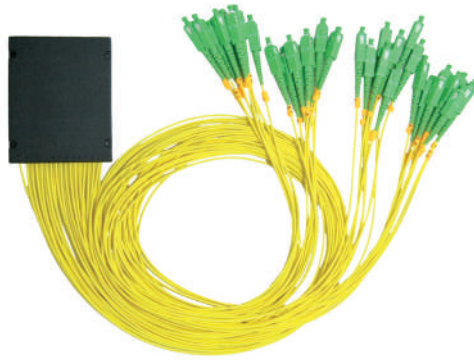

Optical splitters

Description

SM optical splitters, pre-wired with SC/APC adapters at both ends, to be used in the Services Building Entry Point to split the optical signals.

Available sets of 1:4, 1:8, 1:16, 1:32 elements according to the number of building units to be supplied.

Reference standards

ISO/IEC 11801-1/2:2017
ANSI/TIA 568.3-D
ITU-T G.657.A2

Characteristics

Structure	Body of thermoplastic material
Connections	SC/APC
Installation	Services Building Entry Point
Fibre type	SM G.657.A2
Insertion loss	From 7,4 to 16,9 dB
Sets	1:4/ 1:8 / 1:16 / 1:32
Dimensions	From W100xD80xH10 to W120xD80XH18 mm
Colour	Box: black Cable: yellow Adapter SC/APC: green

Code	Description	Packaging
2008296	Optical splitter 9/125 G.657.A2, set 1:4 SC/APC	1 pc
2008297	Optical splitter 9/125 G.657.A2, set 1:8 SC/APC	1 pc
2008298	Optical splitter 9/125 G.657.A2, set 1:16 SC/APC	1 pc
2008299	Optical splitter 9/125 G.657.A2, set 1:32 SC/APC	1 pc

Patch cords and pigtails

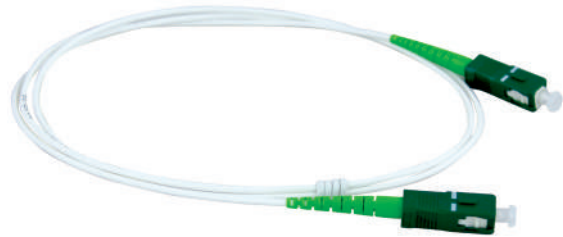
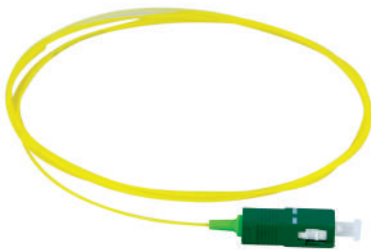

SC/APC pigtail

Description

Single-mode pigtail 9/125 type G.657.A2, terminated with SC/APC connectors.
Suitable to be used in multifiber building systems for the fusion-splice termination of the optical cables inside the Building Entry Point, the Optical Telecommunication Wall Outlet and the MDU Box.

General characteristics

Installation	Building Entry Point, MDU Box, Optical Telecommunication wall Outlet
Cable type	Semi-loose
Connection	SC/APC
Fibre type	SM 9/125 type G.657.A2 Bend Insensitive
Length	2 mt

Reference standard

ISO/IEC 11801-1/2
ANSI/TIA 568.3-D
ITU-T G.657.A2

Code	Description
2008018APC	Single-mode pigtail G.657.A2 SC/APC

SC/APC optical patch cords

Description

Simplex SM optical patch cords 9/125 type G.657.A2, terminated with SC/APC connectors.
Suitable to be used in multifiber-building systems for the services interconnection within the Building Entry Point and the Fiber Access Terminal.
Available lengths of 1, 2 and 3 mt.

General characteristics

Installation	Building Entry Point, Fiber Distribution Box, Optical Telecommunication Outlet
Cable type	Simplex semi Tight with LSZH jacket
Connection	SC/APC – SC/APC
Fibre type	SM 9/125 type G.657.A2 Bend Insensitive
Insertion loss	Typical 0,15 dB

Reference standard

ISO/IEC 11801-1/2:2017
ANSI/TIA 568.3-D
ITU-T G.657.A2

Code	Description
2008291	Simplex patch cord SC/APC-SC/APC 9/125 G.657.A2 L=1m
2008292	Simplex patch cord SC/APC-SC/APC 9/125 G.657.A2 L=2m
2008293	Simplex patch cord SC/APC-SC/APC 9/125 G.657.A2 L=3m

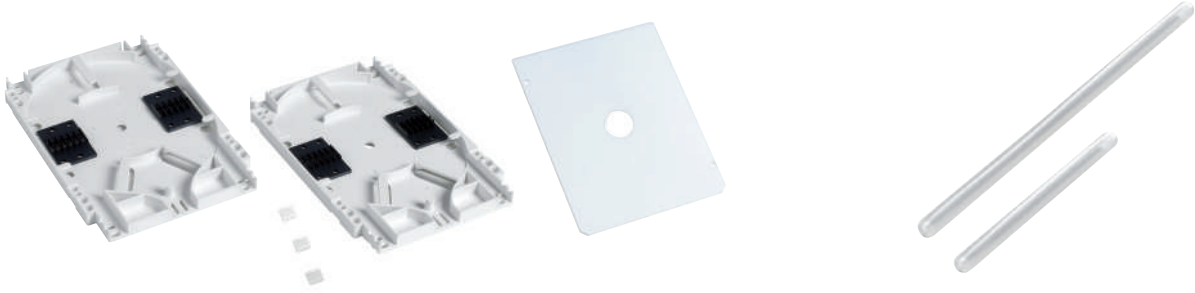

Splice trays

Description

Modular and stackable splice trays with cover. Each tray has 2 organizers which can hold 6 splices each.

The following items are available:

- Base unit
- Additional unit
- Cover for splice tray

Characteristics

Installation	On enclosures or optical trays
Material	Thermoplastic with high mechanical resistance
Capacity	12 splices
Colour	White

Code	Description
2008195	12 FO splice tray
2008196	Additional 12 FO splice tray
2008193	Cover for splice trays

Protection tubes

Description

Reinforced heat shrink tubes, standard length 45 mm and 60 mm against crushing and bending.

Ideal to protect fusion splices.

Characteristics

Installation	On fusion splices
Material	Heat-shrink material reinforced with inner stainless steel protection
Lengths	45/60 mm
Outer diameter	2,5/3,5 mm
Colour	Transparent

Code	Description
2008191	Heat-shrink tubes: diam. 2,5-3,5mm , L 45mm
2008192	Heat-shrink tubes: diam. 2,5-3,5mm , L 60mm

Racks and accessories



Designed and manufactured according to the market requirements, Qubix racks are available in multiple versions with a wide selection of accessories and can be customized on the base of the installation requirements.

The range includes:

- racks for Datacenter and Server rooms with depth 1000 and 1200 mm
- floor standing and wall racks
- racks with degree of protection IP55 and IP65
- 10" racks, racks for special applications like Safety and Compact racks
- ventilation systems, cabling management, PDU and further accessories

<i>Datacenter racks</i>	<i>p. 146</i>
<i>Floor racks</i>	<i>p. 152</i>
<i>Wall racks</i>	<i>p. 158</i>
<i>Small office racks</i>	<i>p. 166</i>
<i>Accessories</i>	<i>p. 171</i>



Racks

Full range of 19" cabinets available both in floor standing and wall mount version. The sizes available for floor standing cabinets go from 22 to 47 units with 600 or 800 mm width and 600 to 1200 mm depth. The wall mounted cabinets are available in 10" or 19" versions, 6 to 22 units, width from 270 to 600 mm. To complete the offer, CCS® includes in the portfolio a wide range of accessories.

Datacenter racks

Tech	p. 146
IP 55	p. 150

Floor racks

Tech	p. 152
IP 55	p. 154

Wall racks

Tech	p. 158
IP 55	p. 160
IP 65	p. 162

Small office racks

Wall Tech D350	p. 166
Safety	p. 167
Compact	p. 168
Wall 10"	p. 169

Racks – Fields of application

ENTERPRISE



DATACENTER RACK



IP 55 RACK

COMMERCIAL



FLOOR RACK



IP55 RACK



WALL RACK

RESIDENTIAL





HOME CONSOLIDATION CABINET



SMALL OFFICE

CCS® range of cabinets and racks offers enclosure solutions that answer the specific needs of different environments, from Datacenter racks with depth of 1200 mm to the smaller cabinets for SOHO applications. New trends and needs come from the market, our R&D Dpt. has therefore revised and improved the range of our racks to offer reliable, functional products combined with a modern design. Specific solutions were also developed for harsh environments with complete range of IP55 racks already configured with all necessary accessories.



Installation Environment		Nr. of units (U)	Available widths (mm)	Available depths (mm)	Static load (kg)	Colour	19" uprights (pcs)	IP rate	Front door	Rear door/ panel
Datacenter		27 42 47	600 800	1000 1200	2000	Grey RAL 7035 Black RAL 9005	4	IP 20	Glass/ Grilled	Panel/ Double grilled door
		42	600 800	1000	750	Grey RAL 7035	4	IP 55	Glass/ Blind	Blind door
Floor		22 27 36 42 47	600 800	600 800	800	Grey RAL 7035 Black RAL 9005	2	IP 20	Glass	Panel
		26 42	600 800	600 800	750	Grey RAL 7035	4	IP 55	Glass/ Blind	Blind door
Wall mounted		6 9 12 15 22	600 570 (flat pack)	450 600	60	Grey RAL 7035 Black RAL 9005	4 2 (flat pack)	IP 20	Glass	Panel
		9 12 16	600	450 600	80 -120	Grey RAL 7035	2 (D450) 4 (D600)	IP 55	Blind	Panel
		10 13 17	600	400 500 600	50 D400/D500 60 D600	Grey RAL 7035	2	IP 65	Glass/ Blind	Panel
Small office		6	600	350	60	Grey RAL 7035	4	IP 20	Glass	Panel
		1 section structure	580	150	20	Grey RAL 7035	--	IP 20	Blind	Panel
		3U+5U	537	150	30	Grey RAL 7035	--	IP 20	Blind with plexiglass window	Panel
		7	358	270	15	Grey RAL 7035	2	IP 20	Glass	Panel

Datacenter **TECH** racks



The new Datacenter TECH racks with high depth represent the perfect choice for Server and Datacenter applications thanks to their specific characteristics. They are available in the version with front glass door and rear blind panel or with front and rear gridded doors, 2-sections side blind panels (1-section for the 27U). They are fully accessorized with no. 4 19" numbered uprights, brush strip cable entry, roof and floor base panels with removable flanges for cable entry, loading weight up to 2000 kg.

Colours

-  Grey RAL 7035
-  Black RAL 9005

Static Load



Dimensions (WxD)

600 x 1000
800 x 1000
800 x 1200

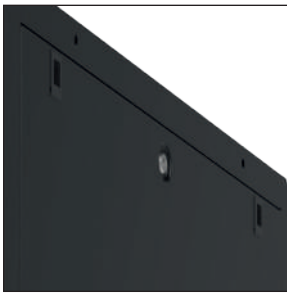

2-section side blind panels



No. 4 numbered uprights adjustable in depth



Front door with 3-point locking system

Datacenter TECH racks

Description

Datacenter TECH cabinets are suitable to house all kinds of server computers and 19" active components that are available in the networking market.

They can house all the 19" accessories and are suitable for the installation of specific accessories with greater depth and weight capacity to contain and support non-modular devices.

The range includes cabinets with width of 600 and 800 mm and depth of 1000 and 1200 mm with front glass door and side and rear blind panels or with front and rear grilled doors and side blind panels.

General characteristics

- Steel sheet structure
- Colour: Grey RAL 7035 or Black RAL 9005
- Configurations with front glass door and side and rear blind panels or front grilled door and rear grilled double door with side blind panels
- Swing handle with key and 3- point locking system
- Door opening 180°
- 2-section blind side panels removable with locking key for the 42U and 47U versions; single section panels for the 27U version
- Ventilation slits for exhaust air and holes for the installation under the roof of ventilation units
- Brush strip cable entry on the base of rack
- Roof and floor base panels with removable trapdoors for cable inlet
- No. 4 19" uprights with unit number and adjustable in depth
- IP20 protection degree according to EN 60529
- Earthing kit
- No. 4 levelling feet
- Loading weight: 2000 Kg
- Compliant with standard IEC 60297, EN 61587-1, EN 60917

Description	Unit	Height	Width	Depth	Grey RAL 7035	Black RAL 9005	Front door	Rear door
Datacenter racks TECH	27U	1350	600	1000	2009128	2009128N	Glass	-
			800	1000	2009138	2009138N	Glass	-
	42U	2000	600	1000	2009115	2009115N	Glass	-
			800	1000	2009171	2009171N	Glass	-
			800	1000	2009163	2009163N	Grilled	Grilled double door
			800	1200	2009159	2009159N	Glass	-
			800	1200	2009164	2009164N	Grilled	Grilled double door
			800	1200	2009164	2009164N	Grilled	Grilled double door
	47U	2240	600	1000	2009143	2009143N	Glass	-
			800	1000	2009134	2009134N	Glass	-

Accessories

Code	Description
2011491	Set of 4 wheels Datacenter racks TECH series
2011494	Set of 4 M12x100 levelling feet - Datacenter racks TECH series



Plinths for Datacenter cabinets

Description

Plinths for Datacenter TECH cabinets to allow and protect cable pass through. The kit consists of No. 4 supports to be installed at the corners of the cabinet and No. 4 removable flanges.

General characteristics

Installation	To be fixed at the base of Datacenter TECH cabinets
Structure	Painted steel sheet
Equipment	No. 4 angle brackets, No. 4 removable flanges for the passage of cables
Height	100 mm
Colour	Grey RAL 7035

Code	Description
2011465	Plinth for Datacenter TECH cabinet W600xD1000
2011466	Plinth for Datacenter TECH cabinet W800xD1000
2011467	Plinth for Datacenter TECH cabinet W800xD1200

Ventilation units for floor and Datacenter cabinets

Description

Ventilation units provided with 2 or 4 fans, with or without thermostat, for allowing air vent inside the cabinet. Suitable for the installation in floor standing and Datacenter TECH cabinets. Roof mounting with 0U space take up.

General characteristics

Installation	Roof mounting in floor standing and Datacenter TECH cabinets
Structure	Sheet steel structure, single fan size 120x120x38 mm, complete with power cable with schuko plug; analogue control thermostat from 0° to + 60° C (where included)
Electrical specification	Power supply 200-240 VAC, power consumption 25W for each fan
Capacity	150 m ³ /h for each fan
Noise level	49 dBA
Colour	Grey RAL 7035

Code	Description
2011442	2-fan ventilation unit for Datacenter TECH cabinets
2011444	4-fan ventilation unit for Datacenter TECH cabinets
2011447	2-fan ventilation unit + thermostat for Datacenter TECH cabinets
2011449	4-fan ventilation unit + thermostat for Datacenter TECH cabinets

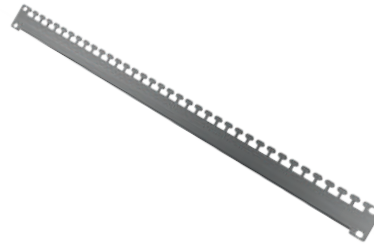

Cable management panel

Description

Pair of cable management panels with painted steel sheet structure complete with a snap-in cover, ideal for an easy and organized management of patch cords inside the cabinets. To be installed only in floor standing and Datacenter TECH cabinets with a width of 800 mm.

General characteristics

Installation	In floor standing and Datacenter TECH cabinets with a width of 800 mm
Structure	Steel sheet structure with a snap-in cover
Colour	Grey RAL 7035

Cable holding bracket

Description

Cable holding bracket made of steel sheet, ideal for managing cable bundles inside the cabinets. To be installed only in Datacenter TECH cabinets.

General characteristics

Installation	Horizontal mounting on the sides of the Datacenter TECH cabinets
Structure	Steel sheet
Size	Length of 882 mm for cabinets with depth of 1000 mm
Colour	Grey

Code	Description
2011438	Pair of cable management panels 42U for TECH cabinets
2011439	Pair of cable management panels 47U for TECH cabinets

Code	Description
2011423	Cable holding bracket for D1000 Datacenter TECH cabinet

Datacenter IP55 racks



Designed to meet special installation needs, especially in the industrial environment, the Datacenter IP55 racks for Server and Datacenter applications allow the installation of devices and servers in harsh work conditions. Depth 1000 mm, front and rear doors with 3-point locking system, no. 4 numbered uprights, plinth, setting for forced ventilation under the roof and eyebolts for the lifting of the rack.

Colour



Grey RAL 7035

Static Load



Dimensions [WxD]

600 x 1000
800 x 1000

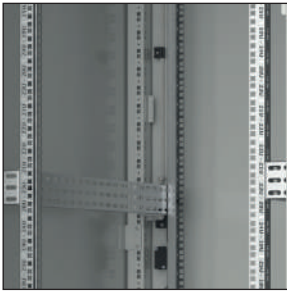

No. 4 numbered uprights adjustable in depth



Side panels with air filters



Ventilation unit

Datacenter IP 55 racks

Description

Datacenter IP cabinets are designed for the containment of all the main types of servers and 19" modular active equipment available in the networking market in environments where it is required a high protection degree. Racks have an IP55 protection degree and are available with a width of 600 or 800 mm and a depth of 1000 mm, equipped with front glass or blind door, rear door and blind side panels.

General characteristics

- Steel sheet structure
- Colour: Grey RAL 7035
- Front glass or blind door with 3-point closing system
- Rear blind door with 3-point closing system
- Blind side panels
- Door opening with lever system
- Removable roof
- No. 4 lifting eyebolts
- Brush strip cable entry on the base of the cabinet
- No. 4 numbered 19" uprights in accordance with IEC 60297-1 adjustable in depth
- Holes for the installation under roof of ventilation units
- Side filters for cabinet ventilation with external protective covers
- Plinth of 100 mm height
- IP55 degree of protection in accordance with EN 60529
- Impact resistance rating IK10 for cabinets with blind doors; IK09 for cabinets with glass doors
- Earthing kit
- Loading weight: 750Kg

Description	Unit	Height	Width	Depth	Grey RAL 7035	Front door
Datacenter IP55 racks	42U	2218	600	1000	2009207	Glass
					2009208	Blind
			800	1000	2009205	Glass
					2009201	Blind

Accessories



Code	Description
2011612	2 Fan ventilation unit with thermostat for floor/datacenter racks IP55

Floor TECH racks



Floor TECH racks are the ideal solution for most installations. Versatility and great variety of configurations are the main characteristics of these racks. Standard configuration is front glass door with opening till 180°, 2-sections side and rear blind panels with locking key (1-section panel in 22 and 27U), no. 2 19" front numbered uprights adjustable in depth, roof and bottom cable inlets, levelling feet.

Colours

-  Grey RAL 7035
-  Black RAL 9005

Static Load



Dimensions (WxD)

- 600 x 600
- 600 x 800
- 800 x 600
- 800 x 800



Hinges with 180° opening angle



Numbered uprights adjustable in depth



Handle with locking key

Floor standing TECH racks

Description

Floor standing TECH cabinets are designed for the containment of the main equipment and 19" accessories for structured cabling and LAN networks. Racks are available with width of 600 or 800 mm and depth of 600 or 800 mm, equipped with front glass door, side and rear removable blind panels.

General characteristics

- Steel sheet structure
- Colour: Grey RAL 7035 or Black RAL 9005
- Front glass door with swing handle with key and 3- point locking system
- Door opening 180°
- 2-sections blind side and rear removable panels with locking key for the 36U, 42U and 47U versions; 1-section blind panels for the 22U and 27U versions
- Ventilation slits for exhaust air and holes for the installation on the roof of ventilation units
- Roof and floor base panel with removable flanges for cable inlet
- No. 2 19" uprights with unit number and adjustable in depth
- IP20 protection degree according to EN 60529
- Earthing kit
- Loading weight: 800Kg
- No. 4 levelling feet
- Compliant with standard IEC 60297, EN 61587-1, EN 60917

Description	Unit	Height	Width	Depth	Grey RAL 7035	Black RAL 9005	Additional uprights
Floor racks TECH	22U	1160	600	600	2009181	2009181N	2011404
	27U	1350	600	600	2009182	2009182N	2011405
			600	800	2009109	2009109N	2011405
	36U	1750	600	600	2009183	2009183N	2011407
			600	800	2009113	2009113N	2011407
			800	600	2009121	2009121N	2011407+2011400
	42U	2000	800	800	2009120	2009120N	2011407+2011400
			600	600	2009184	2009184N	2011408
			600	800	2009112	2009112N	2011408
			800	600	2009114	2009114N	2011408+2011400
	47U	2240	800	800	2009185	2009185N	2011408+2011400
			800	800	2009186	2009186N	2011409+2011400

Accessories

Code	Description
2011493	Set of 4 wheels for racks TECH series
2011492	Set of 4 M10x62 levelling feet TECH series

Floor

TECH racks accessories



Plinths

Description

Plinths for floor standing TECH cabinets to allow and protect cable pass through. The kit consists of No. 4 supports to be installed at the corners of the cabinet and No. 4 removable flanges.

General characteristics

Installation	To be fixed at the base of floor standing TECH cabinets
Structure	Painted steel sheet
Equipment	No. 4 angle brackets, No. 4 removable flanges for the passage of cables
Height	100 mm
Colour	Grey RAL 7035

Code	Description
2011461	Plinth for floor standing TECH cabinet W600xD600
2011462	Plinth for floor standing TECH cabinet W600xD800
2011463	Plinth for floor standing TECH cabinet W800xD600
2011464	Plinth for floor standing TECH cabinet W800xD800

Ventilation units

Description

Ventilation units provided with 2 or 4 fans, with or without thermostat, for allowing air vent inside the cabinet. Suitable for the installation in floor standing and Datacenter TECH cabinets. Roof mounting with 0U space take up.

General characteristics

Installation	Roof mounting in floor standing and Datacenter TECH cabinets
Structure	Sheet steel structure, single fan size 120x120x38 mm, complete with power cable with schuko plug; analogue control thermostat from 0° to +60° C (where included)
Electrical specification	Power supply 200-240 VAC, power consumption 25W for each fan
Capacity	150 m ³ /h for each fan
Noise level	49 dBA
Colour	Grey RAL 7035

Code	Description
2011442	2-fan ventilation unit for Datacenter TECH cabinets
2011444	4-fan ventilation unit for Datacenter TECH cabinets
2011447	2-fan ventilation unit + thermostat for Datac. TECH cabinets
2011449	4-fan ventilation unit + thermostat for Datac. TECH cabinets

Floor

TECH racks accessories

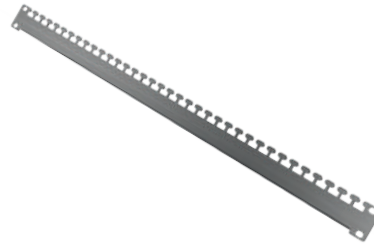

Cable management panel

Description

Pair of cable management panels with painted steel sheet structure complete with a snap-in cover, ideal for an easy and organized management of patch cords inside the cabinets. To be installed only in floor standing and Datacenter TECH cabinets with a width of 800 mm.

General characteristics

Installation	In floor standing TECH cabinets with a width of 800 mm
Structure	Steel sheet structure with a snap-in cover
Colour	Grey RAL 7035

Code	Description
2011437	Pair of cable management panels 36U for TECH cabinets
2011438	Pair of cable management panels 42U for TECH cabinets
2011439	Pair of cable management panels 47U for TECH cabinets

Cable holding bracket

Description

Cable holding bracket made of steel sheet, ideal for managing cables bundles inside the cabinets. To be installed only in floor standing TECH cabinets.

General characteristics

Installation	Horizontal mounting on the sides of the floor standing TECH cabinets
Structure	Steel sheet
Sizes	Lengths of 482 and 682 mm for cabinet with depth respectively of 600 and 800 mm
Colour	Grey

Code	Description
2011421	Cable holding bracket for D600 floor TECH cabinets
2011422	Cable holding bracket for D800 floor TECH cabinets

Floor IP55 racks



The range of floor IP55 racks includes products with specific features for the installation in demanding environments. They are available in multiple versions from 600x600 to 800x800, IP55 protection degree, front and rear doors with 3-point locking system, no. 4 19" numbered uprights, plinth, setting for forced ventilation under the roof and eyebolts for the lifting of the rack.

Colour



Grey RAL 7035

Static Load



Dimensions (WxD)

600 x 600
600 x 800
800 x 800

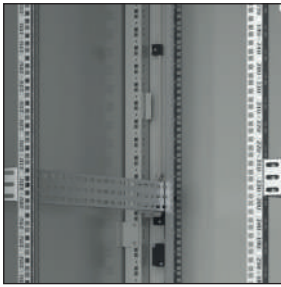

No. 4 numbered uprights adjustable in depth



Side panels with air filters



Ventilation unit

Floor standing IP55 racks

Description

Floor standing IP55 cabinets with width and depth of 600 or 800 mm, front tempered glass or blind door and rear blind door, suitable for the containment of 19" active components and accessories in harsh environments where it's required a high protection degree.

General characteristics

- Steel sheet structure
- Colour: Grey RAL 7035
- Front glass or blind door with 3-point closing system
- Rear blind door with 3-point closing system
- Blind side panels
- Door opening with lever system
- Removable roof
- No. 4 lifting eyebolts
- Brush strip cable entry on the base of the cabinet
- No. 4 numbered 19" uprights in accordance with IEC 60297-1 adjustable in depth
- Holes for the installation under roof of ventilation units
- Side filters for cabinet ventilation with external protective covers
- Plinth of 100 mm height
- IP55 degree of protection in accordance with EN 60529
- Impact resistance rating IK10 for cabinets with blind doors; IK09 for cabinets with glass doors
- Earthing kit
- Loading weight: 750Kg

Description	Unit	Height	Width	Depth	Grey RAL 7035	Front door
Floor racks IP55	26U	1507	600	600	2009202	Glass
					2009203	Blind
			600	800	2009204	Glass
					2009209	Blind
			800	800	2009206	Glass
					2009211	Blind
	42U	2218	600	600	2009214	Glass
					2009215	Blind
			600	800	2009213	Glass
					2009212	Blind
800	800	2009229	Glass			
		2009200	Blind			

Accessories

Code	Description
2011612	2 Fan ventilation unit with thermostat for floor/datacenter racks IP55



Wall TECH racks



Black colour available only in flat pack

Easy to install and to transport, wall mounted cabinets TECH available now in versions from 6 to 22 units with a depth of 450 mm or 600 mm. Bottom and roof ventilation grills, glass door with screen-printed logo and safety key, no. 4 uprights and no. 2 L-shaped brackets, removable blind side panels are the key features of this range. Available in assembled version in grey RAL 7035 or in Flat Pack version in black colour RAL 9005.

Colours

-  Grey RAL 7035 assembled
-  Black RAL 9005 flat pack

Static Load



Dimensions (WxD)

600 x 350
570 x 450
600 x 450
570 x 600
600 x 600

Flat Pack

 Available



Removable side panels

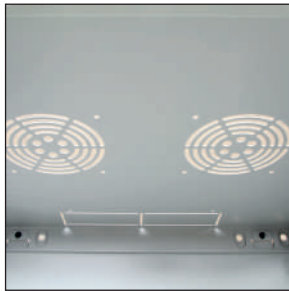

Equipped for 1-fan ventilation unit



No. 4 uprights adjustable in depth (only in the assembled version)

Wall mounted TECH cabinets

Description

Wall mounted cabinets TECH Series are suitable for the housing of the necessary equipment to realize cabling systems and LAN. Side panels can be easily removed giving access to rear cabling. Available with depth of 350, 450 or 600 mm, they can be supplied assembled or in flat-packs.

General characteristics

- Steel sheet structure
- Colour: Grey RAL 7035 for the assembled version; Black RAL 9005 for the flat-pack version
- Tempered safety glass door with >180° opening
- Safety key
- Removable blind side panels
- No. 4 vertical uprights adjustable in depth to install 19" standard equipment for the assembled version; no. 2 frontal 19" uprights for the flat-pack version
- No.2 L-shaped brackets for the equipment mount (only for the assembled version)
- Top and bottom cables inlet
- Ventilation slots allow air vent
- Suitable for the installation of forced ventilation units
- IP20 degree of protection according to EN 60529
- Static load 60 kg

Description	Unit	Height	Width		Depth	Grey RAL 7035 assembled	Black RAL 9005 Flat Pack
			Standard	Flat Pack			
Wall TECH racks	6U	370	600	-	350	2020021	-
		370	600	570	450	2020031	2020031NF
	9U	500	600	570	450	2020032	2020032NF
		500	600	570	600	2020042	2020042NF
	12U	635	600	570	450	2020034	2020034NF
		635	600	570	600	2020044	2020044NF
	15U	770	600	570	450	2020035	2020035NF
		770	600	570	600	2020045	2020045NF
	22U	1080	600	570	600	2020046	2020046NF

Accessories

Code	Description
2011081	1 Fan ventilation unit for wall racks PRO and TECH

Wall IP55 racks



Wall mounted cabinets IP55 are specifically designed to protect the cabling components and the connection equipments in any working condition. The range includes versions ranging from 9 to 16 units, depth 450 or 600 mm, front blind door, hinged roof, cable inlets in the bottom and setting for the forced ventilation under the roof.

Colour



Grey RAL 7035

Static Load



racks 9U



racks 12U



racks 16U

Dimensions (WxD)

600 x 450
600 x 600



Locking system with double key locks



Side air filters



Ventilation unit

Wall mounted IP55 cabinets

Description

Wall mounted IP55 cabinets designed for the containment of components for structured cabling and LAN networks to be installed in environments where a high protection degree is required. The range includes cabinets with a depth of 450 or 600 mm, front blind door and a hinged roof.

General characteristics

- Steel sheet structure
- Blind front door
- Locking system with double key locks
- Colour Grey RAL 7035
- No. 2 numbered 19" uprights adjustable in depth for the 450 mm depth version; no. 4 uprights for the 600 mm depth version
- Cable inlets on the base with PG cable glands and plastic gaskets pre-installed
- Hinged roof with ventilation slots
- Roof designed to house forced ventilation units with 2 fans
- Air filters on the sides with external covers
- IP55 protection degree according to EN 60529
- Degree of impact resistance: IK10
- Equipped for grounding
- Loading weight from 80 to 120 Kg depending on the model

Description	Unit	Height	Width	Depth	Code
Wall racks IP55	9U	543	600	450	2010302
			600	600	2010322
	12U	676	600	450	2010303
			600	600	2010323
	16U	854	600	450	2010304
			600	600	2010324

Accessories

Code	Description
2011616	2 Fan ventilation unit with thermostat for racks IP55
2011602	Kit for pole fixing for wall racks IP55
2011601	Pair of wall fixing brackets for wall racks IP55

Wall IP65 racks



Wall mounted cabinets IP65 are specifically designed to protect the cabling components and the connection equipments in any working condition. The range includes versions from 10 to 17 units, depth 400, 500 or 600 mm, equipped with glass or blind door, no. 2 uprights, bottom plate and cable entry flanges IP65, heaters, filters and fans, wall or pole mounting supports.

Colour



Grey RAL 7035

Static Load



D 400/500



D 600

Dimensions (WxD)

600 x 400
600 x 500
600 x 600



Pole mounting support available



Removable cable inlet flange



Blind door version

Wall mounted IP65 cabinets

Description

Wall mounted IP65 cabinets designed for the containment of components for structured cabling and LAN networks to be installed in environments where a high protection degree is required. The range includes cabinets with depth from 400 to 600 mm, front tempered glass or blind door.

General characteristics

- 15/10 steel sheet body
- Blind or glass front door
- Colour grey RAL 7035
- No.2 19" uprights
- No.2 sendimir profiles fixed on the door
- Cable entry plate with gasket
- Locking system with double bit key, Ø 3mm
- Kit of grounding screws
- IP65 protection degree according to EN60529
- Degree of impact resistance: IK10 for models with blind door according to EN 62208, IK09 for glass door
- Static load 50 Kg (for cabinet with depth of 400-500 mm) or 60 Kg (for cabinet with depth of 600 mm)

In case of ventilation or conditioning systems installation, the cabinet has to be pre-fitted accordingly

Description	Unit	Height	Width	Depth	Glass door	Blind door
Wall mounted IP65 racks	10U	500	600	400	2010201	2010207
			600	500	2010204	2010210
	13U	600	600	400	2010202	2010208
			600	500	2010205	2010223
			600	600	2010212	2010213
	17U	800	600	400	2010203	2010209
			600	500	2010206	2010211
			600	600	2010215	2010218
			600	600	2010215	2010218

Accessories

Description	Code
Kit for pole fixing for wall racks IP65 serie	2011331
Pair of wall fixing brackets for wall racks IP65	2011304



IP55 fans

Description

IP55 fans with grid and particle filter to allow air vent inside the wall mounted IP65 cabinets. To be ordered combined with the IP55 filters and together with the wall IP rack for the correct positioning of the holes on the rack.
Available with a air flow capacity from 40 to 386 mc/h.

General characteristics

Installation	On wall mounted IP65 cabinets
Structure	Fan body in Aluminum; body and external grid in plastic material (UL94 VO)
Air flow capacity	40 m ³ /h, 90 m ³ /h and 386 m ³ /h depending on the model
Dimensions & compatibility	150x150x80 mm -> Rack depth ≥ 400 mm 204x204x98,5 mm -> Rack depth ≥ 500 mm 322x322x143,5 mm -> Rack depth ≥ 600 mm
IP degree	IP55
Colour	Grey for the grid Black for the fan body

Code	Description	Packaging
2011307	IP55 fan 40 mc/h - 150x150 mm	1 pc.
2011319	IP55 fan 90 mc/h - 204x204 mm	1 pc.
2011324	IP55 fan 386 mc/h - 322x322 mm	1 pc.
2011328	Cabinet installation of 1 kit IP55 fan + IP55 filter	1 pc.



IP55 particle filters

Description

IP55 anti-impurity filters with grid for wall mounted IP65 cabinets available in different dimensions according to the requested air-flow. It is possible to install either 2 filters for the natural ventilation or 1 filter + 1 fan with the same dimension for the forced ventilation. To be ordered combined with the IP55 fans and together with the IP rack for the correct positioning of the holes on the rack.

General characteristics

Installation	On wall mounted IP65 cabinets
Structure	Body and external grid in plastic material (UL94-VO)
Dimensions	150x150x24 mm 204x204x30,5 mm 322x322x30,5 mm
IP degree	IP55
Colour	Grey

Code	Description	Packaging
2011306	IP55 filter 150x150 mm	1 pc.
2011318	IP55 filter 204x204 mm	1 pc.
2011323	IP55 filter 322x322 mm	1 pc.
2011328	Cabinet installation of 1 kit IP55 fan + IP55 filter	1 pc.

Small office racks

Wall TECH D350



Small Office TECH cabinet D350

Description

Small Office cabinet with reduced depth (350 mm) and removable side panels. Suitable for housing the necessary equipment and accessories to realize small structured cabling systems.

General characteristics

- Steel sheet structure
- Colour Grey RAL 7035
- Tempered safety glass door with >180° opening
- Safety key
- Removable blind side panels
- No. 4 vertical uprights adjustable in depth to install 19" standard equipment
- No.2 L-shaped brackets for the equipment mount
- Top and bottom cables inlet
- Ventilation slots allow air vent
- Suitable for the installation of forced ventilation units
- IP20 degree of protection according to EN 60529
- Static load 60 kg

Code	Description	Packaging
2020021	Small Office TECH cabinet W600xD350xH370 - 6 Units	1 pc.

Small office racks

Safety rack



Small Office Safety cabinet

Description

Wall mounted cabinet suitable for housing monitor, video recorder or any other device which needs to be protected against unauthorized access.

The devices are mounted on the lid by fixing them on proper 1U brackets while the monitor is installed on the bottom by the use of the available VESA fastening.

General characteristics

- One section steel sheet structure
- Safety double-key lock with diversified encoding
- Tray to lodge the devices 36,5 cm wide, equipped with 1U brackets and adjustable in width between 24 to 48 cm
- 1U brackets are replaceable with 2U ones
- Flaps to fix a 10" 4 sockets PDU
- Ventilation slots on all sides allow air vent. Equipped for the installation of 1-fan ventilation unit
- Pre-sheared profiles grant the cables inlet through the lower part of the side panels and on the bottom
- Bottom fastening to install monitors type VESA 50x50, 75x75, 100X100
- Dimensions W580xH546xD150 mm
- Colour Grey RAL 7035

Code	Description	Packaging
2010071	Small Office Safety cabinet W580xD150xH546 Grey RAL 7035	1 pc.
2010072	2U bracket for Small Office Safety cabinet	1 pc.
2010070	10" horizontal PDU with 2 sockets	1 pc.

Small office racks

Compact

Small Office Compact cabinet

Description

Compact wall mounted cabinet characterized by small dimensions, hinged locking system with plexiglass window and security key, with 5U fixed 19" rails and 3U adjustable 19" rails. Ideal for small structured cabling systems.

General characteristics

- Steel sheet structure
- Colour: Grey RAL 7035
- Closing/opening system with hinges on the back of the cabinet
- Lock with security key
- Plexiglass window
- 3U adjustable 19" front rails for accessories or equipment with maximum depth of 360 mm
- 5U fixed 19" rails for accessories or equipment with a maximum depth of 80 mm
- Side and bottom holes for the ventilation
- Cable entry holes in the bottom
- Load capacity: 30 kg



Code	Description	Packaging
2010073	Small Office Compact cabinet W537xD150xH475 - 3U adjustable + 5U fixed	1 pc.



Small Office 10" cabinet

Description

10" enclosure for wall or desk installations, RAL 7035 varnished steel sheet structure with safety glass door and removable side panels, suitable for housing devices necessary to realize home and office networks.

General characteristics

- Steel sheet structure
- Safety tempered glass door with 180° opening
- Removable side panels
- Two 10" uprights adjustable in depth
- Top and bottom sides have removable trapdoors for cables inlet
- Dimensions: W358xD270xH386 mm, 7U
- Colour: Grey RAL 7035
- IP20 degree of protection according to EN 60529
- Equipped for grounding

Code	Description	Packaging
2010060	Small office 10" cabinet W358xD270xH386 - 7U - removable side panels	1 pc.

Small office racks

Wall 10'' - Accessories



RJ45 panel

Characteristics

- Varnished steel sheet structure
- No.8 blank ports for CCS RJ45 jacks
- 1 Unit
- Grey RAL 7035

Code
2010066
Description
10" 8-port blank panel for CCS RJ45 jacks - 1U



Optical Box SC/LC Duplex

Characteristics

- Varnished steel sheet structure
- No.8 blank ports for SC Simplex or LC Duplex adapters
- 1 Unit, depth 137 mm
- Grey RAL 7035

Code
2010068
Description
10" 8-port optical box for SC Simplex/LC Duplex adapters



Cable management panel

Characteristics

- Varnished steel sheet structure with No.2 cable management rings
- 1 Unit
- Grey RAL 7035

Code
2010062
Description
10" wire guide with 2 rings - 1U



Blind panel

Characteristics

- Varnished steel sheet structure
- 1 Unit
- Grey RAL 7035

Code
2010064
Description
10" blind panel - 1U



Fix shelf

Characteristics

- Varnished steel sheet structure
- Depth: 185 mm
- 1 Unit
- Grey RAL 7035

Code
2010063
Description
10" fix shelf - 185mm depth- 1U



Power distribution unit

Characteristics

- Varnished steel sheet structure, black
- No.2 2P+T sockets
- 16A/250V light switch
- 10"; 1 Unit
- Cable H05VV-F 3G1,5 L=2,5 mt without plug

Code
2010070
Description
10" horizontal PDU

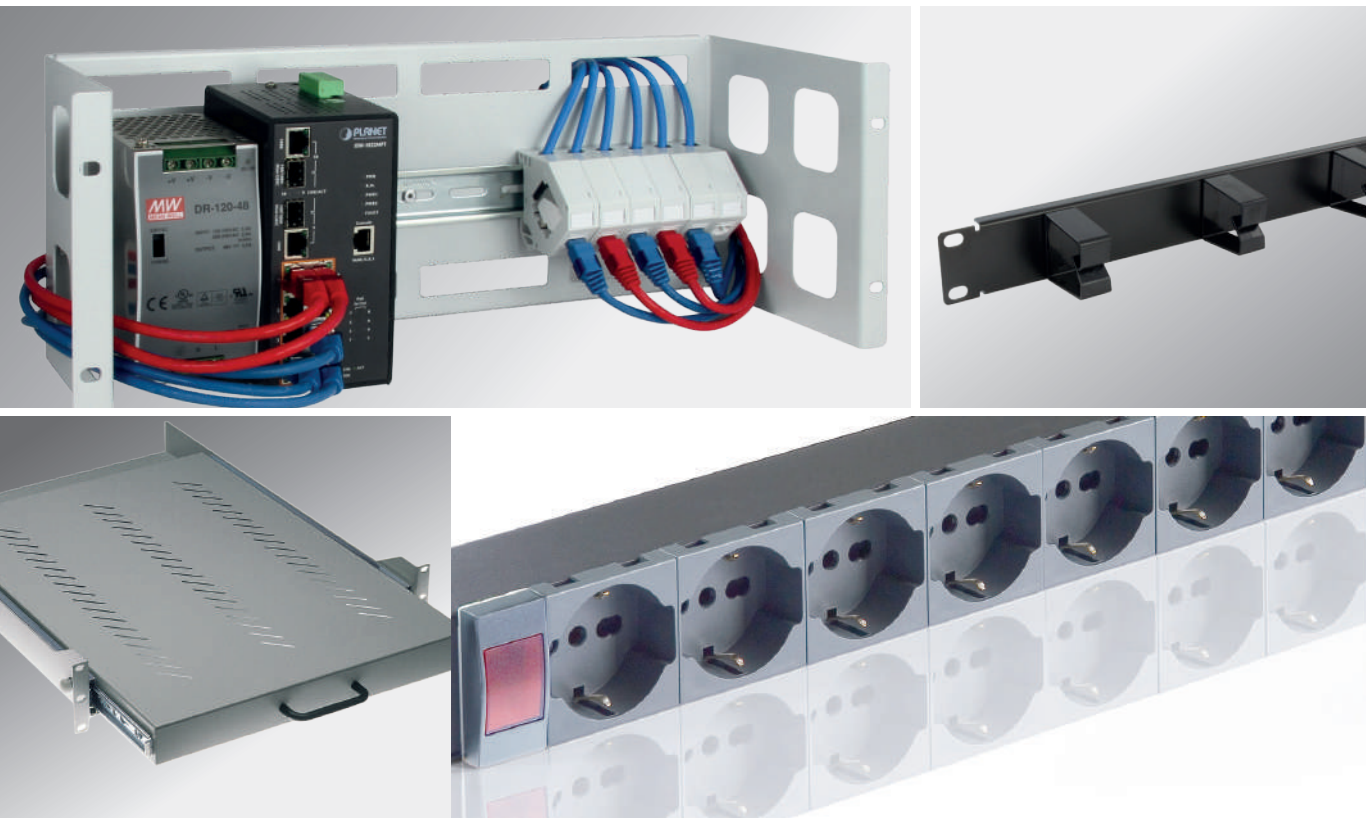

Accessories 19"

To complete the range, CCS® offers a wide selection of universal or specific accessories for every series of cabinets, including horizontal or vertical wiring management, ventilation, power supply and support equipment.

Fixed shelves	p. 172
Sliding shelves	p. 173
Blind panels and drawer	p. 174
Cabling management	p. 175
Ventilation	p. 178
DIN-rail	p. 179
PDU	p. 180
Plinths for cabinets	p. 182
Grounding and lighting	p. 183

Accessories

Fixed shelves



DEPTH 250 - 400



DEPTH 470 - 600 - 750

Fixed shelves

Description

19" fixed shelves with varnished steel sheet structure with depth from 250 to 750 mm for the support of non-modular equipments.
According to their depth, the shelves are to be fastened on the 2 front or on all the 4 uprights.
The choice of the suitable shelf depends on the cabinet depth and uprights equipment according to the chart below.

General characteristics

Installation	On 19" cabinets, fixing on 2 or 4 uprights according to the type of shelf
Structure	Varnished steel sheet
Dimensions	19" – 2 Units depth: 250/400/470/600/750 mm
Load	Between 25 to 80 kg according to the type
Colour	Grey RAL 7035

Code	Depth (mm)	Load (kg)	Fixing	Minimum cabinet depth (mm)
2011004	250	25	On 2 uprights	320
2011003	400	25	On 2 uprights	500
2011079	470	80	On 4 uprights	600
2011070	600	80	On 4 uprights	800
2011072	750	80	On 4 uprights	1000

Accessories

Sliding shelves



Sliding shelves

Description

19" sliding shelves with varnished steel sheet structure, with depth between 470 and 750 mm, equipped with rear bar for the fastening on 4 uprights, suitable for the support of non-modular equipments. The choice of the shelf depends on the cabinet depth and uprights equipment.

General characteristics

Installation	On 19" cabinets, fixing on 4 uprights
Structure	Varnished steel sheet
Dimensions	19"; 2 Units depth : 470/600/750 mm
Load	Between 40 and 50 Kg according to the type
Colour	Grey RAL 7035

Code	Depth (mm)	Load (kg)	Fixing	Minimum cabinet depth (mm)
2011019	470	50	On 4 uprights	600
2011089	600	40	On 4 uprights	800
2011116	750	40	On 4 uprights	1000

Accessories

Blind panels and drawer

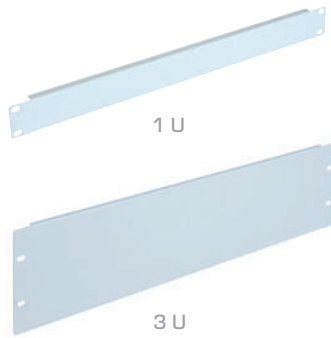

Blind panels

Description

Varnished steel sheet blind panels for the closure of blanks inside the cabinet.

General characteristics

Installation	On 19" cabinets
Structure	Varnished steel sheet
Dimensions	19"; 1-3 Units
Colour	Grey RAL 7035 or Black RAL 9005

Drawer

Description

19" drawer with varnished steel sheet structure, mounting on 4 uprights, with safety key and suitable for the installation in cabinets with a depth of 600, 800 and 1000 mm.

General characteristics

Installation	On 19" cabinets; horizontal mounting on 4 uprights
Structure	Varnished steel sheet (thickness:20/10); max load: 20 Kg
Dimensions	19"; 2 Units; depth: 480 mm
Colour	Grey RAL 7035

Code	Description
2011005	Blind panel 1 U - Grey
2011007	Blind panel 3U - Grey
2011009	Blind panel 1U - Black
2011027	Blind panel 3U - Black

Code	Description
2011091	19" drawer 2U

Accessories

Cabling management



Cable management panel Black

Characteristics

- Installation on 19" cabinets, suitable for the horizontal cabling management
- Varnished steel sheet structure with 4 ABS cable management rings
- Dimensions: 19" -1U
- Colour Black RAL 9005

Code
2011018
Description
Cable management panel 1U - Black

Cable management panel Grey

Characteristics

- Installation on 19" cabinets, suitable for the horizontal cabling management
- Varnished steel sheet structure with 4 ABS cable management rings
- Dimensions: 19" -1U
- Colour Grey RAL 7035

Code
2011017
Description
Cable management panel 1U - Grey



Cable management panel with cover 1U

Characteristics

- Installation on 19" cabinets, suitable for the horizontal cabling management
- ABS base, cover and cable management rings
- Dimensions: 19"- 1U – Depth 70 mm
- Colour Black

Code
2011130
Description
Cable management panel with cover D70 mm 1U

Accessories

Cabling management

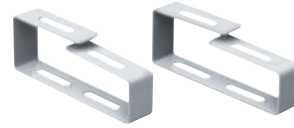

Cable management panel with brush

Description

19" Cable management panel with brush suitable for managing cables bundles inside the cabinets.

General characteristics

Installation	On 19" cabinets
Structure	Varnished steel sheet frame
Dimensions	19" - 1U
Colour	Black RAL 9005

Cable management rings

Description

Cable management ring made of varnished steel sheet, suitable for managing cables bundles inside the cabinets.

General characteristics

Installation	On cabinets, horizontal or vertical mounting
Structure	Varnished steel sheet
Dimensions	106x79 mm
Colour	Grey RAL 7035

Code	Description
2011118	Cable management panel with brush

Code	Description
2011021	Cable management ring

Accessories

Cabling management



Cable management panel

Description

Pair of cable management panels with painted steel sheet structure complete with a snap-in cover, ideal for an easy and organized management of patch cords inside the cabinets. To be installed only in floor standing and Datacenter TECH cabinets with a width of 800 mm.

General characteristics

Installation	In floor standing and Datacenter TECH cabinets with a width of 800 mm
Structure	Steel sheet structure with a snap-in cover
Colour	Grey RAL 7035

Code	Description
2011437	Pair of cable management panels 36U for TECH cabinets
2011438	Pair of cable management panels 42U for TECH cabinets
2011439	Pair of cable management panels 47U for TECH cabinets

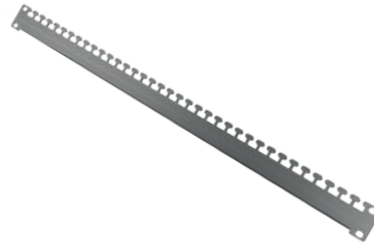

Cable holding bracket

Description

Cable holding bracket made of steel sheet, ideal for managing cables bundles inside the cabinets. To be installed in floor standing and Datacenter TECH cabinets.

General characteristics

Installation	Horizontal mounting on the sides of the floor and Datacenter TECH cabinets
Structure	Steel sheet
Size	Lengths of 482, 682 and 882 mm for cabinets with depth respectively of 600, 800 and 1000 mm
Colour	Grey

Code	Description
2011421	Cable holding bracket for D600 floor TECH cabinets
2011422	Cable holding bracket for D800 floor TECH cabinets
2011423	Cable holding bracket for D1000 Datacenter TECH cabinets

Accessories

Ventilation



Ventilation units for floor and Datacenter cabinets

Description

Ventilation units provided with 2 or 4 fans, with or without thermostat, for allowing air vent inside the cabinet. Suitable for the installation in floor standing and Datacenter TECH cabinets. Roof mounting with 0U space take up.

General characteristics

Installation	Roof mounting in floor standing and Datacenter TECH cabinets
Structure	Sheet steel structure, single fan size 120x120x38 mm, complete with power cable with schuko plug; analogue control thermostat from 0° to +60° C (where included)
Electrical specification	Power supply 200-240 VAC, power consumption 25W for each fan
Capacity	150 m ³ /h for each fan
Noise level	49 dBA
Colour	Grey RAL 7035

Code	Description
2011442	2-fan ventilation unit for TECH cabinets
2011444	4-fan ventilation unit for TECH cabinets
2011447	2-fan ventilation unit with thermostat for TECH cabinets
2011449	4-fan ventilation unit with thermostat for TECH cabinets

Fan for wall cabinets

Description

Single fan without thermostat, for allowing air vent inside the cabinet. Suitable for the installation in wall mounting TECH cabinets. Roof mounting with 0U space take up.

General characteristics

Installation	Roof mounting in wall TECH cabinets
Structure	Cast aluminum structure, fan size 120x120x44 mm
Electrical specification	Power supply 200-240 VAC, power consumption 25W
Capacity	150 m ³ /h
Noise level	43 dBA
Colour	Black

Code	Description
2011081	Axial fan for wall TECH cabinets

Accessories

DIN-rail

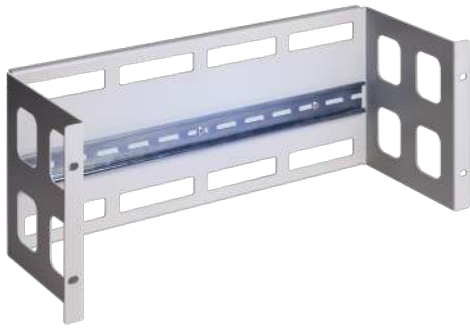

DIN-rail guide

Description

4 unit DIN-rail guide, with increased depth and height and specific holes for the cables inlet. Suitable for the installation of equipments and accessories inside 19" racks .

General characteristics

Structure	Varnished steel sheet structure equipped with DIN-rail; side and rear holes for the cabling management
No. of DIN modules	Max. 24
Dimensions	19"; 4 Units ; Depth 150 mm
Installation	On CCS 19" racks; frontal fixing on uprights
Colour	Grey RAL 7035

Code	Description
2011171	19" DIN-rail guide - 4U

Enclosure for DIN mounting device

Description

Enclosure for DIN mounting device suitable for the installation of modular equipment inside 19" racks .

General characteristics

Structure	Varnished steel sheet structure equipped with DIN rail and front cover with hole; max. dispersible power 120W
Dimensions	19"; 3 Units ; Depth 55 mm
Installation	On CCS 19" racks; horizontal fixing on uprights
Colour	Grey RAL 7035

Code	Description
2011094	19" enclosure for DIN mounting device

Accessories

PDU



PDU with surge protection 6 Schuko sockets

Description

Power distribution unit with 6 Schuko sockets, light switch and power surge protection. Ideal to power active equipments inside racks.

General characteristics

Installation	On horizontal or vertical uprights
Structure	ABS frame with 6 sockets 2P+T Italian and German standard P11 and P30; light switch
Equipment	Cable H05VV-F 3G1 mmq L=1,5 mt with 16A Schuko plug
Power consumption	16A thermal protection with manual back-in-use; surge protection
Dimensions	19", 1 Unit
Colour	Black RAL 9005

Code	2011014
Description	PDU with power surge protection - 6 sockets

PDU with surge protection 8 Schuko sockets

Description

Power distribution unit with 8 Schuko sockets, light switch and power surge protection. Ideal to power active equipments inside racks.

General characteristics

Installation	On horizontal or vertical uprights
Structure	ABS frame with 8 Schuko sockets 2P+T German standard; light switch
Equipment	Cable H05VV-F 3G1 mmq L=1,5 mt with 16A Schuko plug
Power consumption	Current overload and power surge protection; EMI/RFI filter
Dimensions	19", 1 Unit
Colour	Black RAL 9005

Code	2011164
Description	PDU with power surge protection - 8 sockets

PDU with light switch

Description

Power distribution unit with 6 sockets and light switch. Ideal to power active equipments inside racks.

General characteristics

Installation	On horizontal or vertical uprights
Structure	Varnished steel sheet frame with 6 sockets 2P+T Italian and German standard; light switch
Equipment	Cable H05VV-F 3G1,5 mmq L=2 mt with Schuko plug
Power consumption	Max. 16A at 250V
Dimensions	19", 1 Unit
Colour	Black

Code	2011120
Description	PDU with light switch – 6 sockets

Accessories

PDU



PDU with warning light

Description

Power distribution unit with 9 sockets and warning light. Ideal to power active equipments inside racks.

General characteristics

Installation	On horizontal or vertical uprights
Structure	Varnished steel sheet frame with 9 sockets 2P+T Italian and German standard; warning light
Equipment	Cable H05VV-F 3G1,5 mm L=2 mt, with Schuko plug
Power consumption	Max. 16A at 250V
Dimensions	19", 1 Unit
Colour	Black

Code	2011121
Description	PDU with warning light - 9 sockets

PDU with magneto-thermal switch

Description

Compact power distribution units with 5-6-9 sockets and magneto-thermal switch. Ideal to power active equipments inside racks.

General characteristics

Installation	On horizontal or vertical uprights
Structure	Varnished steel sheet frame with 5-6-9 sockets 2P+T Italian and German standard; 16A magneto-thermal switch
Equipment	Cable H05VV-F 3G1,5 mmq L=2 mt with Schuko plug
Power consumption	Max 16A, thermal protection at 250V with manual back-in-use
Dimensions	19"; 1 Unit
Colour	Black

Code	2011122
Description	PDU with magneto-thermal switch - 5 sockets

Code	2011123
Description	PDU with magneto-thermal switch - 6 sockets

Code	2011124
Description	PDU with magneto-thermal switch - 9 sockets

Vertical PDU with magneto-thermal switch

Description

Power distribution unit with 12 sockets and magneto-thermal switch, vertical fixing only. Ideal to power active equipments inside racks.

General characteristics

Installation	Vertical fixing only
Structure	Varnished steel sheet frame with 12 sockets 2P+T Italian and German standard; 16A magneto-thermal switch
Equipment	Cable H05VV-F 3G1,5 mmq L=2 mt with Schuko plug
Power consumption	Max 16A, thermal protection at 250V with manual back-in-use
Dimensions	L760,7 mm; 1 Unit
Colour	Black

Code	2011125
Description	Vertical PDU with magneto-thermal switch - 12 sockets

Accessories

Plinths

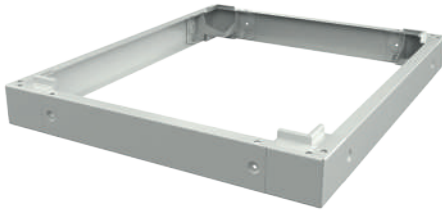

Plinths for Datacenter cabinets

Description

Plinths for Datacenter TECH cabinets to allow and protect cable pass through. The kit consists of No. 4 supports to be installed at the corners of the cabinet and No. 4 removable flanges.

General characteristics

Installation	To be fixed at the base of Datacenter TECH cabinets
Structure	Painted steel sheet
Equipment	No. 4 angle brackets, No. 4 removable flanges for the passage of cables
Height	100 mm
Colour	Grey RAL 7035

Plinths

Description

Plinths for floor standing TECH cabinets to allow and protect cable pass through. The kit consists of No. 4 supports to be installed at the corners of the cabinet and No. 4 removable flanges.

General characteristics

Installation	To be fixed at the base of floor standing TECH cabinets
Structure	Painted steel sheet
Equipment	No. 4 angle brackets, No. 4 removable flanges for the passage of cables
Height	100 mm
Colour	Grey RAL 7035

Code	Description
2011465	Plinth for Datacenter TECH cabinet W600xD1000
2011466	Plinth for Datacenter TECH cabinet W800xD1000
2011467	Plinth for Datacenter TECH cabinet W800xD1200

Code	Description
2011461	Plinth for floor TECH cabinet W600xD600
2011462	Plinth for floor TECH cabinet W600xD800
2011463	Plinth for floor TECH cabinet W800xD600
2011464	Plinth for floor TECH cabinet W800xD800

Accessories

Grounding and lighting

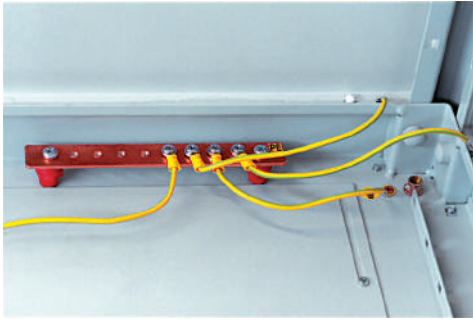

Copper bar for grounding

Characteristics

- Copper bar with No.10 M6 bores L240xD25xH3 mm
- No. 2 36 mm high insulators with M6 bores
- No. 4 M6x14 screws and No. 4 washers

Code
2011103
Description
Copper bar for grounding

LED lamp

Characteristics

- Dimensions: 277x23x36 mm
- Efficiency: 310 Lumen/mt
- Power: 100-230VAC/ 4W
- Cable 1,5 mt long with plug

Code
2011134
Description
LED lamp



Screws and cage nuts

Characteristics

- M6x12 zinc plated steel screws (UNI 7687)
- M6 cage nuts - white zinc plated steel
- Packing unit: 50 pcs

Code
2011013
Description
Screws and cage nuts

Product index

Code	Page	Code	Page	Code	Page	Code	Page	Code	Page
2001015	50	2004098	75	2006006	100	2008024OM4	113	2008115	114
2001016	50	2004099	75	2006015	102	2008025	111	2008116	114
2001017	50	2004100	75	2006016	102	2008025OM3	112	2008117	114
2001018	48	2004102	75	2006017	100	2008025OM4	113	2008118	114
2001019	48	2004103	75	2006030	102	2008026	111	2008119	114
2001020	48	2004104	75	2006031	133	2008026OM3	112	2008120	114
2001023	36	2004105	75	2006032	102	2008026OM4	113	2008121	114
2001025	36	2004106	137	2006040	131	2008027	111	2008122	114
2001027	38	2004151	73	2006050	131	2008027OM3	112	2008131	111
2001028	39	2004152	73	2006051	131	2008027OM4	113	2008131OM3	112
2001029	40	2004153	73	2006071	103	2008028	111	2008131OM4	113
2002012	42	2004154	73	2006072	103	2008028OM3	112	2008132	111
2002013	42	2004155	72	2006073	103	2008028OM4	113	2008132OM3	112
2002014	73	2004156	72	2006080	98	2008029	108	2008132OM4	113
2002019	73	2004157	72	2006081	99	2008030	111	2008133	111
2002021	58	2004158	137	2006082	99	2008030OM3	112	2008133OM3	112
2002023	58	2004159	136	2006083	99	2008030OM4	113	2008133OM4	113
2002027	59	2004160	136	2006084	99	2008031	111	2008134	111
2002028	60	2004201	130	2006085	99	2008031OM3	112	2008134OM3	112
2002029	60	2004210	130	2006086	99	2008031OM4	113	2008134OM4	113
2002035	49	2004211	130	2006087	99	2008032	111	2008135	111
2002036	49	2004212	130	2006088	99	2008032OM3	112	2008135OM3	112
2002037	51	2004213	130	2006089	99	2008032OM4	113	2008135OM4	113
2002038	51	2004214	130	2007001	106	2008033	108	2008136	111
2002043	41	2004215	130	2007003	106	2008033OM3	108	2008136OM3	112
2002047	43	2004221	130	2007011	106	2008033OM4	108	2008136OM4	113
2002048	44	2004223	130	2007011OM3	106	2008034	108	2008137	111
2002049	44	2004225	130	2007011OM4	106	2008034OM3	108	2008137OM3	112
2002051	37	2004241	129	2007012	106	2008034OM4	108	2008137OM4	113
2002053	45	2004242	129	2007012OM3	106	2008035	108	2008138	111
2002055	55	2004243	129	2007012OM4	106	2008036	108	2008138OM3	112
2003005	70	2004244	129	2007013	106	2008037	108	2008138OM4	113
2004004	76	2004245	129	2007013OM3	106	2008038	108	2008140	111
2004012	70	2004246	129	2007013OM4	106	2008038APC	108	2008140OM3	112
2004013	70	2005010	61	2007021	106	2008039	111	2008140OM4	113
2004014	70	2005021	64	2007021APC	106	2008039OM3	112	2008141	111
2004018	61	2005022	64	2007021FAPC	138	2008039OM4	113	2008141OM3	112
2004026	75	2005023	64	2007022	106	2008051	89	2008141OM4	113
2004027	75	2005024	64	2007023	106	2008052	89	2008142	111
2004028	75	2005025	64	2007040	115	2008053	89	2008142OM3	112
2004029	75	2005026	64	2007041	116	2008056	89	2008142OM4	113
2004030	75	2005027	64	2007043	116	2008061	90	2008149	111
2004031	75	2005028	64	2007044	116	2008061OM3	90	2008149OM3	112
2004032	75	2005029	64	2007045	116	2008061OM4	90	2008149OM4	113
2004033	75	2005030	64	2007046	116	2008062	90	2008191	107
2004034	75	2005031	64	2007083	103	2008062OM3	90	2008192	107
2004035	75	2005032	64	2007084	103	2008062OM4	90	2008193	107
2004036	75	2005033	64	2008001	114	2008063	90	2008195	107
2004037	75	2005034	64	2008002	114	2008063OM3	90	2008196	107
2004038	75	2005035	64	2008003	114	2008063OM4	90	2008210	94
2004042	72	2005045	64	2008004	114	2008064	90	2008211	94
2004043	71	2005046	64	2008005	114	2008064OM3	90	2008212	94
2004044	71	2005047	64	2008006	114	2008064OM4	90	2008213	94
2004057	75	2005048	64	2008007	114	2008065	90	2008214	94
2004058	75	2005061	65	2008008	114	2008066	90	2008216	94
2004059	72	2005062	65	2008009	114	2008067	90	2008218	94
2004062	72	2005063	65	2008010	114	2008068	90	2008219	94
2004063	75	2005066	65	2008011	114	2008081	89	2008220	94
2004064	75	2005067	65	2008012	114	2008081OM3	89	2008221	94
2004070	74	2005068	65	2008015	109	2008081OM4	89	2008222	94
2004071	74	2005069	65	2008015OM3	109	2008083	89	2008223	94
2004072	74	2005071	65	2008015OM4	109	2008083OM3	89	2008224	94
2004073	74	2005072	65	2008016	109	2008083OM4	89	2008226	94
2004074	74	2005073	65	2008016OM3	109	2008084	89	2008228	94
2004075	75	2005076	65	2008016OM4	109	2008084OM3	89	2008229	94
2004076	75	2005081	66	2008017	109	2008084OM4	89	2008240	94
2004077	75	2005082	66	2008018	109	2008086	89	2008241	94
2004078	75	2005083	66	2008018APC	140	2008086OM3	89	2008242	94
2004079	75	2005084	66	2008019	108	2008086OM4	89	2008243	94
2004080	75	2005091	66	2008019OM3	108	2008087	91	2008244	94
2004081	75	2005092	66	2008019OM4	108	2008087OM3	91	2008246	94
2004082	75	2005093	66	2008020	108	2008087OM4	91	2008248	94
2004084	75	2005094	66	2008021	111	2008088	92	2008249	94
2004088	105	2005111	65	2008021OM3	112	2008088OM3	92	2008250	110
2004089	105	2005112	65	2008021OM4	113	2008088OM4	92	2008251	110
2004089APC	138	2005113	65	2008022	111	2008100	89	2008252	110
2004090	105	2005114	65	2008022OM3	112	2008105	89	2008253	110
2004091	105	2005121	65	2008022OM4	113	2008107	89	2008254	110
2004092	75	2005122	65	2008023	111	2008108	89	2008255	110
2004093	75	2005123	65	2008023OM3	112	2008111	114	2008256	110
2004094	56	2005124	65	2008023OM4	113	2008112	114	2008257	110
2004095	56	2006004	101	2008024	111	2008113	114	2008258	110
2004097	75	2006005	100	2008024OM3	112	2008114	114	2008259	110

Product index

Code	Page	Code	Page	Code	Page	Code	Page
2008260	110	2008371	95	2009186N	147	2011318	165
2008261	110	2008372	95	2009200	157	2011319	164
2008262	110	2008373OM3	95	2009201	151	2011323	165
2008263	110	2008373OM4	95	2009202	157	2011324	164
2008264	110	2008374OM3	95	2009203	157	2011328	164
2008265	110	2008374OM4	95	2009204	157	2011331	163
2008266	110	2008375OM3	95	2009205	151	2011400	153
2008267	110	2008375OM4	95	2009206	157	2011404	153
2008268	110	2008380	90	2009207	151	2011405	153
2008269	110	2008381	90	2009208	151	2011407	153
2008270	110	2008382	90	2009209	157	2011408	153
2008271	110	2008383	90	2009211	157	2011409	153
2008272	110	2008411	89	2009212	157	2011421	177
2008273	110	2008412	89	2009213	157	2011422	177
2008291	140	2008413	89	2009214	157	2011423	177
2008292	140	2008414	89	2009215	157	2011437	177
2008293	140	2008416OM3	89	2009229	157	2011438	177
2008296	139	2008416OM4	89	2010060	169	2011439	177
2008297	139	2008417OM3	89	2010062	170	2011442	178
2008298	139	2008417OM4	89	2010063	170	2011444	178
2008299	139	2008418OM3	89	2010064	170	2011447	178
2008302	91	2008418OM4	89	2010066	170	2011449	178
2008303	91	2008419OM3	89	2010068	170	2011461	182
2008304	91	2008419OM4	89	2010070	170	2011462	182
2008305	91	2008423	90	2010071	167	2011463	182
2008306	91	2008428OM3	90	2010072	167	2011464	182
2008306OM3	91	2008428OM4	90	2010201	163	2011465	182
2008306OM4	91	2008432	89	2010202	163	2011466	182
2008307	91	2008434	89	2010203	163	2011467	182
2008307OM3	91	2008435	89	2010204	163	2011491	147
2008307OM4	91	2008436OM3	89	2010205	163	2011492	153
2008308	91	2008436OM4	89	2010206	163	2011493	153
2008308OM3	91	2008438OM3	89	2010207	163	2011494	147
2008308OM4	91	2008438OM4	89	2010208	163	2011601	161
2008309	91	2008439OM3	89	2010209	163	2011602	161
2008310	91	2008439OM4	89	2010210	163	2011612	151
2008311	91	2008451	128	2010211	163	2011616	151
2008312	91	2008452	128	2010212	163	2012001	67
2008321	92	2008453	128	2010213	163	2012002	67
2008323	92	2008456	128	2010215	163	2012003	52
2008324	92	2008457	128	2010218	163	2012005	67
2008325	92	2008458	128	2010223	163	2012006	67
2008326	92	2009109	153	2010302	161	2012007	52
2008326OM3	92	2009109N	153	2010303	161	2012008	53
2008326OM4	92	2009112	153	2010304	161	2012009	53
2008328	92	2009112N	153	2010322	161	2012011	68
2008328OM3	92	2009113	153	2010323	161	2012012	68
2008328OM4	92	2009113N	153	2010324	161	2012013	68
2008329	92	2009114	153	2011003	172	2012014	68
2008329OM3	92	2009114N	153	2011004	172	2012025	46
2008329OM4	92	2009115	147	2011005	174	2012026	46
2008330	92	2009115N	147	2011007	174	2012027	54
2008332	92	2009120	153	2011009	174	2020021	166
2008333	92	2009120N	153	2011013	183	2020031	159
2008334	92	2009121	153	2011014	180	2020031NF	159
2008340	96	2009121N	153	2011017	175	2020032	159
2008341	96	2009128	147	2011018	175	2020032NF	159
2008342	96	2009128N	147	2011019	173	2020034	159
2008345	95	2009134	147	2011021	176	2020034NF	159
2008347	95	2009134N	147	2011027	174	2020035	159
2008348	95	2009138	147	2011070	172	2020035NF	159
2008349	95	2009138N	147	2011072	172	2020042	159
2008350	96	2009143	147	2011079	172	2020042NF	159
2008351	96	2009143N	147	2011081	178	2020044	159
2008351OM3	96	2009159	147	2011089	173	2020044NF	159
2008352	96	2009159N	147	2011091	174	2020045	159
2008355	95	2009163	147	2011094	179	2020045NF	159
2008355OM3	95	2009163N	147	2011103	183	2020046	159
2008357	95	2009164	147	2011116	173	2020046NF	159
2008357OM3	95	2009164N	147	2011118	176	2040052	122
2008358	95	2009171	147	2011120	180	2040086	68
2008358OM3	95	2009171N	147	2011121	181	2040088	122
2008358OM4	95	2009181	147	2011122	181	2040153	68
2008359	95	2009181N	147	2011123	181	2040162	118
2008359OM3	95	2009182	147	2011124	181	2040163	119
2008359OM4	95	2009182N	147	2011125	181	2040240	120
2008360	96	2009183	147	2011130	175	2040303	121
2008361	96	2009183N	147	2011134	183	2040305	121
2008365	95	2009184	147	2011164	180	2040306	121
2008367	95	2009184N	147	2011171	179	2040317	121
2008368	95	2009185	147	2011304	163	2040343	120
2008369	95	2009185N	147	2011306	165	2050005	135
2008370	95	2009186	147	2011307	164	2050022	135

Sales Conditions

1. SCOPE

These conditions govern all contracts for the supply of products by Qubix SpA.
Any exceptions will be valid if made in writing within individual contracts.
These terms and conditions also apply to any future contracts between the same parties, except agreed otherwise.

2. DEFINITIONS

The term "Products" means the goods currently manufactured/sold by the Supplier and covered by the contract.
The term "Supplier" means the Company Qubix S.p.A.
The term "Purchaser" means the customer.

3. PRODUCT FEATURES

Information or data on the characteristics and/or technical specifications of products contained in brochures, price lists, catalogues or similar documents shall be binding only to the extent that such data have been explicitly stated in the Contract.

4. TRANSFER OF OWNERSHIP

The transfer of ownership of the products is subject to the full payment of the price by the Purchaser.

5. CONCLUSION OF CONTRACT

The order confirmation entails the acceptance of these general terms and conditions without any reservation.
Every order must be received by Qubix SpA in writing and signed by the Purchaser.
Normally verbal orders are not accepted, any exceptions due to exceptional reasons are totally at the Purchaser's risk.
The Purchaser's order is considered accepted only after the issuance of the order confirmation with all conditions set forth in it.

6. ORDER CANCELLATIONS

The order cancellation of products not held on stock and/or produced exclusively under the Purchaser's order are subject to the following penalties:
Cancellation received within 3 days from the order confirmation: 10% of the order value
Cancellation received within 7 days from the order confirmation: 80% of the order value.

7. DELIVERY

The delivery time listed in the order confirmation is indicative and may be subject to delays beyond the control of Qubix SpA.
Any delay, whether due to Qubix SpA or not, cannot justify the cancellation of the order. Delays due to Qubix SpA may give rise to a claim for compensation only where and to the extent those penalties have been established for that purpose and formalized in writing in advance.
Standard delivery term is EXW Padova Incoterms® 2010, unless otherwise agreed.

8. PACKING

The package is included in the normal list price.
Any special packaging required in writing by the customer will be billed at cost.

9. COMPLAINTS

Any complaint must be in writing and sent to Qubix SpA by registered letter A.R. within eight days from receipt of goods.
Claims relating to the quantity or appearance of products (apparent defects), must be notified by registered letter to the Supplier, under pain of forfeiture, within eight days from the date of receipt of goods. Any claims relating to defects not detectable by a careful inspection upon receipt (hidden defects) shall be communicated to the Supplier by registered letter, under pain of forfeiture, within eight days from the date of discovery of the defect but not later than the warranty period.
By way of exception, claims related to damage from transportation and authorized by the Supplier will have to be communicated to the Supplier within 24 hours of receipt of the goods by sending a copy of the waybill of the carrier, affixed with clear and specific reservations and with full photographic documentation.

10. WARRANTY

The Supplier guarantees the good quality of products by committing, during the warranty period stated below, to repair, or, under his sole discretion, free replace those parts which due to the bad quality of the material or manufacturing defects are faulty, provided this does not depend on:
- natural attrition
- failures caused by incompetence or negligence of the Purchaser
- imperfect assembly (unless the same has not been performed by the Supplier)
- tampering or interventions not authorized by the Supplier
Unless otherwise specified for the type of product, the warranty period is 12 months from the date of delivery and shall expire at the end of the period even though the products were not, for whatever reason, put in place. The warranty claim is subject to compliance with the terms of complaints as specified above. In case of defects, lack of quality or lack of conformity of products, the Supplier is only required to repair or replace them.
The above obligation to repair or replace the Products shall be in lieu of any warranty or liability of any kind required by law (eg. for defects, lack of quality or lack of conformity of the Products) and excludes all other liability of the Purchaser (whether in-or-extra contract) due to defects, lack of quality or non-compliance of products sold (eg. compensation for damages of plant shutdown, lost profits, etc.).
The return of products under warranty must be agreed with Qubix SpA, that will determine the delivery mode of goods.
All material to be repaired must be accompanied by an indication of the fault, otherwise the goods will not be accepted.

11. RETURNS

All returns must first be approved by the sales office of Qubix SpA by sending an authorization form and a RMA number.
The acceptance of returns is subject to sole discretion of Qubix SpA and is conditioned by the following clauses:
- product delivered to the Purchaser by no later than 8 days;
- unopened original packaging;
- current production model;
- return shipping cost prepaid.

12. TERMS OF PAYMENT

Payments must be made in the form agreed and specified in the order confirmation.
In case of late payment with respect to agreed date, the Purchaser must pay the Supplier interests on late payment in accordance with Legislative Decree no. 231/02.
The Purchaser is not authorized to make any deduction from the agreed price, unless prior written agreement with the Supplier. If the Supplier has any reason to fear that the buyer can not or do not intend to pay the Products at the agreed date, he will subject the delivery of products to the provision of adequate guarantees of payment.

13. GOVERNING LAW, ARBITRATION

13.1 This Agreement shall be construed and governed by Italian Law
13.2 Every effort will be made by both parties to settle amicably any disputes, misunderstandings or differences that may arise in connection with this Agreement.
13.3 If such a settlement can not be reached, all disputes arising out or in connection with the present Agreement shall be finally settled under the Rules of Arbitration of the International Chamber of Commerce of Paris by one arbitrator appointed in accordance with the said rules; the arbitration will be directed in the English Language and will take place in Padova (Italy).

WEEE EUROPEAN DIRECTIVE (2012/19/EU)

Waste from Electrical and Electronic Equipment

The WEEE Directive aims to reduce the volume of waste from electrical and electronic equipment (EEE). It requires that some end-of-life products can not be landfilled but must be managed by a system that provides for separate collection and for a specific treatment of separation, recycling and recovery. According to the RAEE Directive QUBIX SpA has set up all the procedures for the commercialization of EEE of the brands Qubix SpA manages the marketing: - entrust to the group ecoRit the management activities of the end-to-life equipment - cost internalization of WEEE disposal in the selling price of the EEE (WEEE eco-contribution acquitted) - enrolment to the National Register of producers as required by Ministerial Decree 25 September 2007, No 185 - affixing of the crossed out bin symbol on individual items covered by the Directive. The crossed out bin symbol indicates that the end-of-life product must be separately collected from other waste and separately deposited at authorized collection centers, in the cases and manner prescribed by national laws of EU countries, to avoid adverse effects on the environment and human health. Illegal disposal of end-of-life products is sanctioned by law. It is in any case appropriate that the consumers verify that in his country the product is actually subject to the WEEE regulations.

Products distributed by Qubix Spa that are included in the WEEE European Directive 2012/19/EU

PRODUCT DESCRIPTION/MANUFACTURER	COMMODITY CATEGORY
Active equipments for data networks - Planet	6.8
Videosurveillance equipments - Planet/Qubix	6.8
PDU, patch-cords for domestic use	5.24
Verification instruments for data networks in copper and fiber	5.21

Group: ERION WEEE
FEE description: eco-tax paid

Edition: June 2023

Qubix SpA. reserves the right to change at any time and without notice the features and specifications of the products shown.

© Qubix S.p.A. All rights reserved.

It is highly prohibited to copy, publish and/or use any content of the catalogue without the formal authorization by Qubix SpA.
All the included material is protected by copyright: contents (registered trademarks, texts, images or other contents) are of exclusive property of Qubix SpA.



**CCS CONNECTIVITY
& CABLING SYSTEM**

is a trademark of:

Qubix S.p.A. networking solutions
Via Canada, 22/A - 35127 Padova - ITALY
Tel. +39 049 7801994 - Fax +39 049 775667

www.ccs-cabling.it